

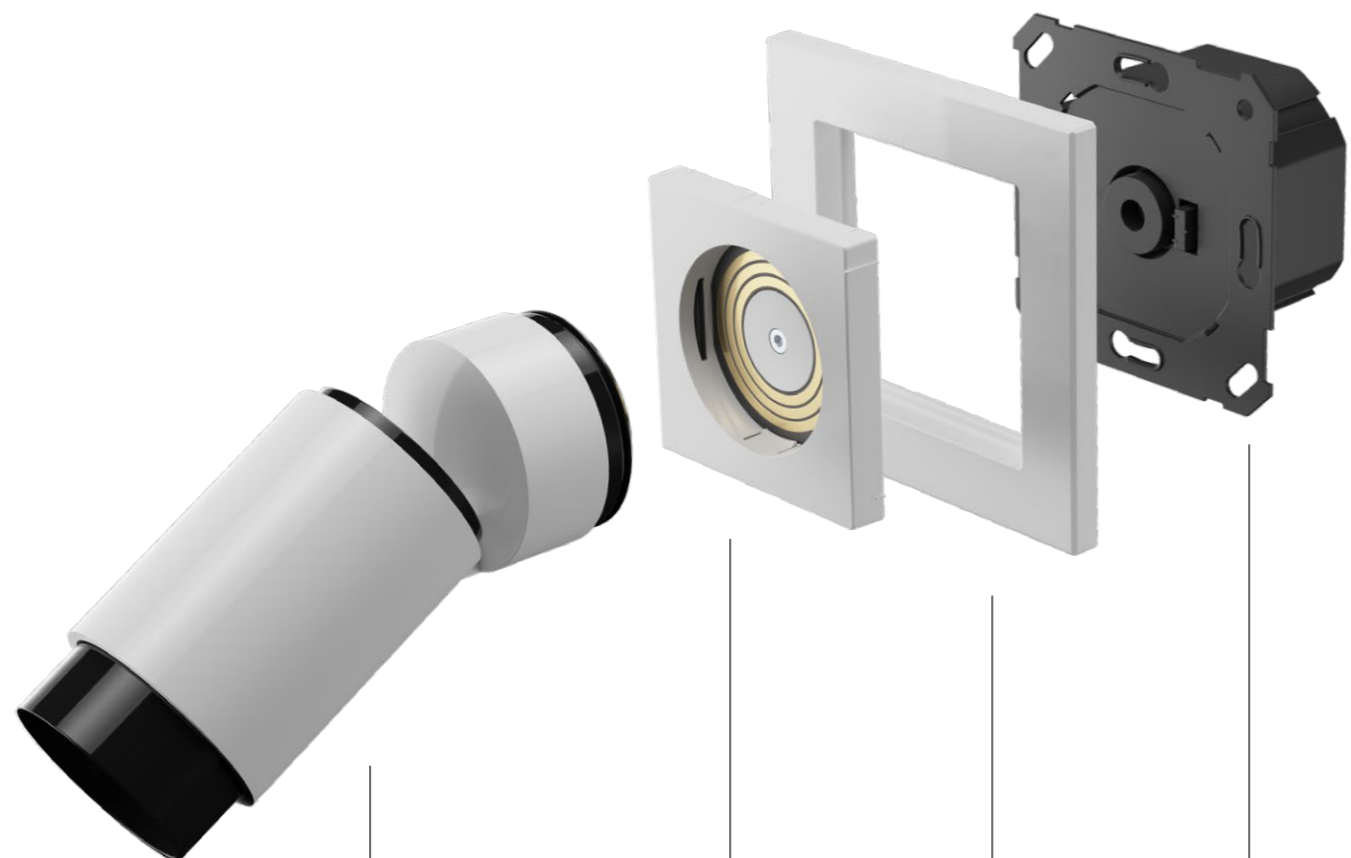

**LIGHT. DIRECTLY FROM
THE SOCKET.**



PLUG & LIGHT. THE FIRST LIGHT SOCKET.



Plug & Light spotlight

Gira and Jung offer the light socket in selected switch ranges.

Three gold-plated sliding contacts simultaneously establish an electrical connection and transmit data from the light socket to the attachment.

The light socket can be installed in all standard European appliance sockets.

Welcome to the new world of lighting design! It's modular, agile and extremely comfortable. It's *Plug & Light*. When expert knowledge from different fields is recombined in new ways, it not only generates additional benefits through an increase in ideas: such partnerships can also spark off genuine innovation. And that's exactly what *Insta*, *Gira*, *Jung* and *Brumberg* have achieved. The *Plug & Light* concept is an absolute novelty in flexible interior lighting design that allows docking and exchanging matching luminaires at will—and all without the need for installation.

As the developer of *Plug & Light*, *Insta* is paving the way for a new approach in lighting design. Together with *Gira* and *Jung*, *Insta* has already been able to get two strong partners on board from the field of electrical installation and smart building technology. A company specialising in luminaire design has also joined the alliance: *Brumberg* is the first *Plug & Light* partner who has developed five matching ranges of luminaires. This means that a large variety of options in application and design are already available for the commercial launch of *Plug & Light*.

Symbols of a hyperconnected era

Where living and work spaces become more hybrid, where the living room is spontaneously turned into an office, where the dining table becomes a worktable, where the hotel lobby transforms into a co-working space and where the café is used as a cocktail bar in the evening, that's where lighting requirements are changing too: they are becoming more complex. *Plug & Light* responds to this development. A new lighting system that supports the flexibility we need to guarantee comfort in our future everyday life.

Plug & Light allows changing the light situation as needed: quickly and safely, with modular and high-end components. *Plug & Light*: light sockets installed in flush-mounted wall boxes to which various luminaires can be docked, immediately ready for operation and exchangeable easily at any time. But that's not all. *Plug & Light* is based on the concept of a connected world, open to further development. Other manufacturers are invited to also create new switch and luminaire designs. The development potential is huge.

Writing lighting history

"We cannot touch light, but it touches us", says Tobias Link. This statement is spot-on and shows how significant good lighting is. In an interview (p. 12) the lighting designer, who has created the concept design for *Plug & Light*, talks about how it all came about, where *Plug & Light* is headed and which new dimensions will open up in future lighting.

The field of future worlds of lighting is huge, exciting and complex. We would like to invite you to become a regular reader of the *Plug & Light Magazine*. Here we'll not only report on the latest developments in *Plug & Light*, but also on all topics related to light and innovation, as well as on fascinating exhibitions and events. Come and have a look at: www.plugandlight.de!

Apropos of news: even before its commercial launch, *Plug & Light* has been recognised with two renowned prizes, the *2019 German Design Award* and the *2018 Innovation Award Architecture + Technology*. This shows that the world of design and architecture needs future-oriented solutions.

THE PLUG & LIGHT PRINCIPLE

Re-thinking light



Simply dock the *Plug & Light* luminaire to the light socket and illuminate the room with the desired lighting situation. *Plug & Light* functions that simply. Lighting sourced directly from the socket.

The innovative *Plug & Light* system is constructed in a modular fashion. The user can attach and replace other luminaires at will—no further installation necessary. With this system, *Plug & Light* redefines interior lighting. It can be adjusted to any given situation. Atmospheric lighting becomes incredibly easy.

Hot-plugging included

An innovative construction makes this principle possible: the light attachment is affixed to the light socket with a strong magnet. Three gold-plated sliding contacts simultaneously establish an electrical connection. In addition to the energy required for the operation of the LED light source, this also transmits data from the light socket to the attachment. In this way, lighting attachments can not only be optimally dimmed but also equipped with a range of useful additional functions. A light attachment with the warm-dim function, for example, automatically changes its colour temperature when dimmed, simulating the cosy light atmosphere of a good old incandescent light bulb.

Due to its magnetic axis of rotation and gold-plated sliding contacts, the light attachment can be rotated by 360 degrees without a limit stop and can be easily exchanged at any time: in no time at all, the ceiling spotlight can be replaced by a pendant, even if the pendant features different technical qualities. The new light attachment is immediately ready for use. A new ambiance is created in no time at all.

The light socket can be installed in all standard European appliance sockets, making *Plug & Light* incredibly easy to use.

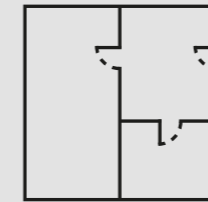

Flexible lighting design

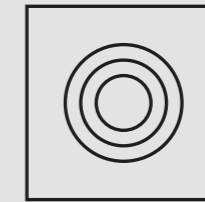

Easily interchangeable thanks to magnetic connection

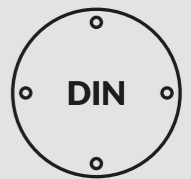

Simple installation in standard European appliance sockets

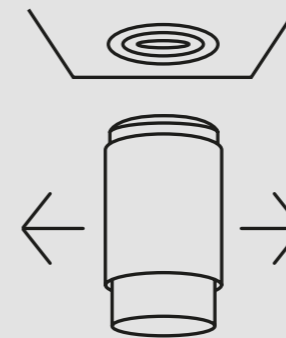

Multiple application and design options

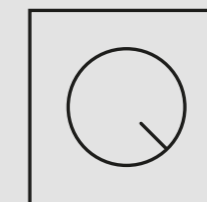

Flicker-free dimmable LED light

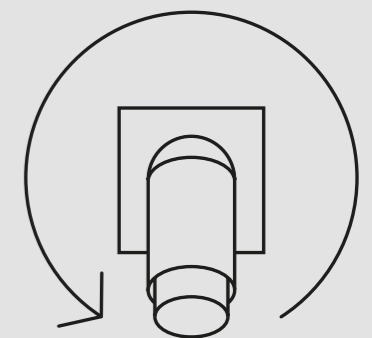

360° freely pivotable light attachments



**CHANGE THE ATMOSPHERE AND
FUNCTION OF A ROOM IN THE
BLINK OF AN EYE**
—at home or in a hotel

Plug & Light makes it possible to experience adjustable lighting in a new dimension.

With *Plug & Light*, atmosphere and room function can be repeatedly and effectively modified according to the situation, quickly and easily. Perfectly compatible with our modern lifestyle, in which spatial structures and interiors are becoming increasingly flexible and the demand for high-quality lighting and variability is growing.

Plug & Light even brings a new quality to urban living in small spaces: the wall spotlight, for example, which brightly illuminates the kitchen worktop, later — turned by 180°—creates a pleasant, indirect light for an aperitif or a dinner party. In a single move, a change of the light attachment transforms the perfectly lit workspace into a cosy dining table. Moreover, the spotlight on the wall of a hotel room — turned in the right direction—becomes a reading light.

The 12 V safety low voltage also makes the system safe to the touch. Disassembly protection is also available.

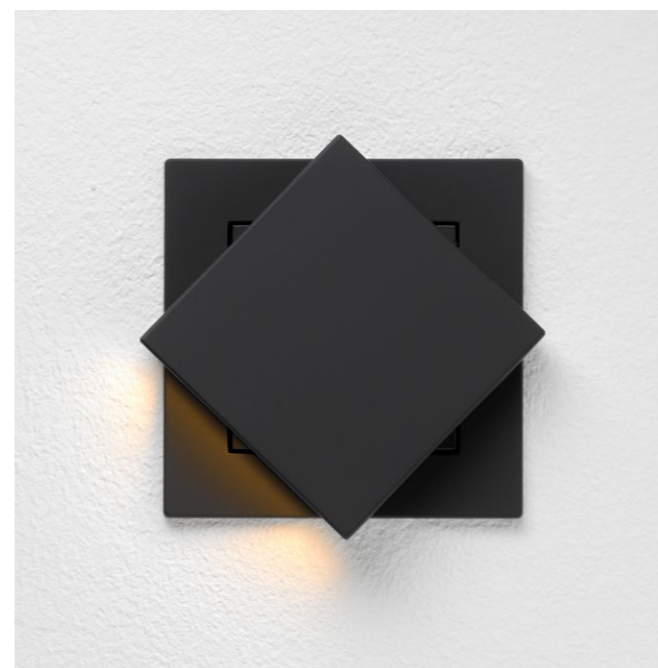

Plug & Light floodlight Gira E2

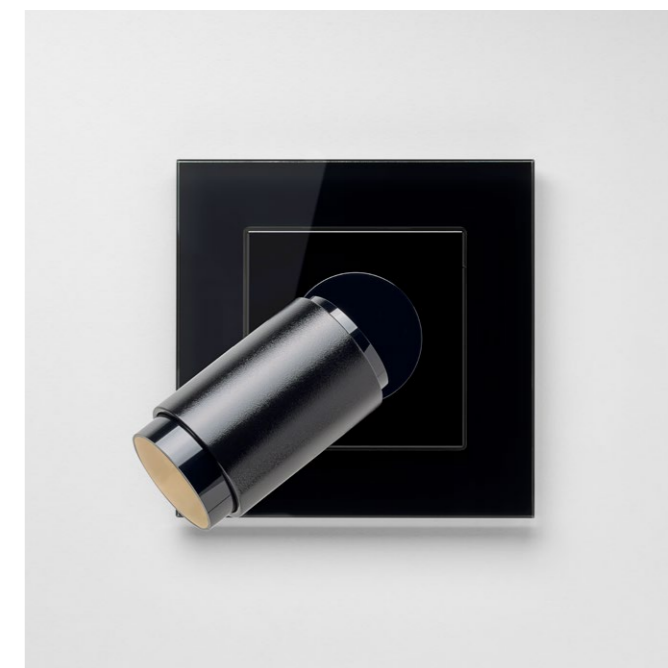

Plug & Light spotlight Jung A creation

Plug & Light spotlight Jung LS 990



Plug & Light luminaire Brumberg
MiniQ pendant | white

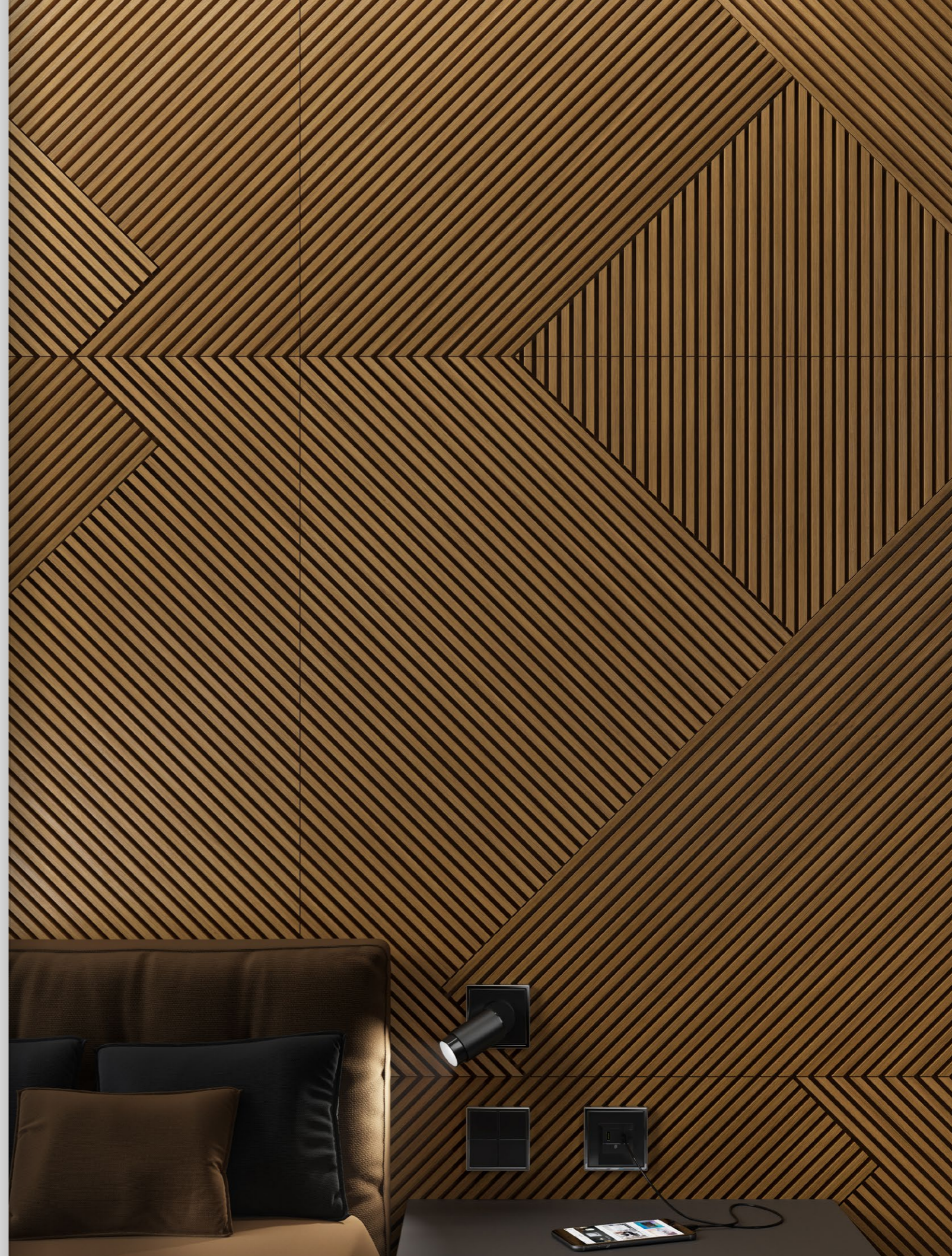

PLANNED FLEXIBILITY.

A system with unlimited opportunities

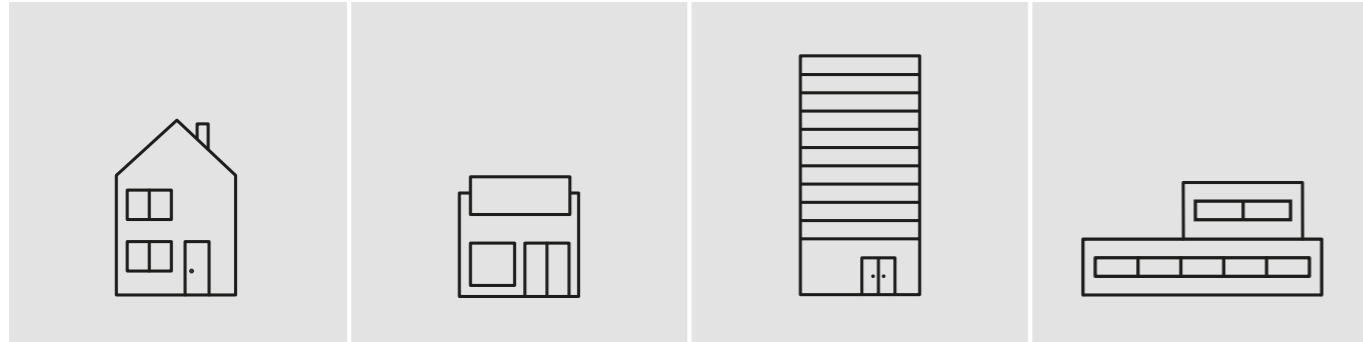

Plug & Light—an innovative solution in upmarket residential construction and for discerning owners.

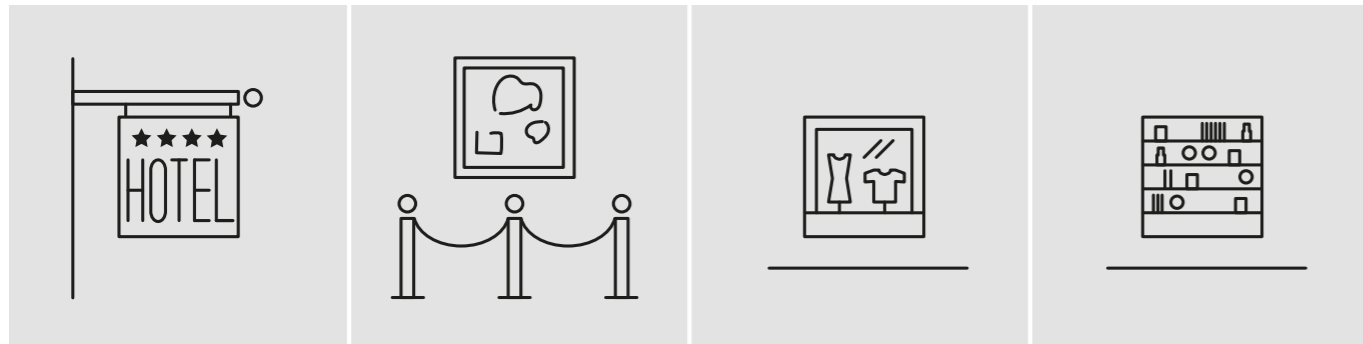

Plug & Light—an innovative solution within the hospitality sector and unique lighting scenarios.

***Plug & Light* stands for the maximum of flexibility in planning. Merely the positions of the sockets and switches for future light sources need to be planned during the building phase. The appropriate design and the desired light attachments can be reselected again and again, even after completion. Sampling the matching *Plug & Light* luminaires is incredibly straightforward, time-consuming installation and de-installation a thing of the past: once the light socket has been fitted, the various light attachments can be quickly attached and interchanged thanks to the magnet system. For the uncomplicated installation of a bespoke lighting situation.**

Plug & Light spotlight Gira E2



To the taste of architects and designers

Switch and luminaire design used to be two separate fields. With *Plug & Light*, switch and luminaire design can come from a single source. This supports the high aesthetic demands of architects and designers: for the first time, they can select both switches and luminaires in a uniform language of form, colour and material, thus perfectly matching the entire lighting installation to the architecture and interior.

Plug & Light is available in the various switch designs by *Gira* and *Jung*. The light attachments in the *Gira* or *Jung* design, released for the launch of *Plug & Light*, match the design of the corresponding switch programmes.

Five ranges of luminaires by specialist brand *Brumberg* provide even more options for decorative lighting from the socket. For example, for upmarket residential buildings, for discerning homeowners and for the hospitality industry.

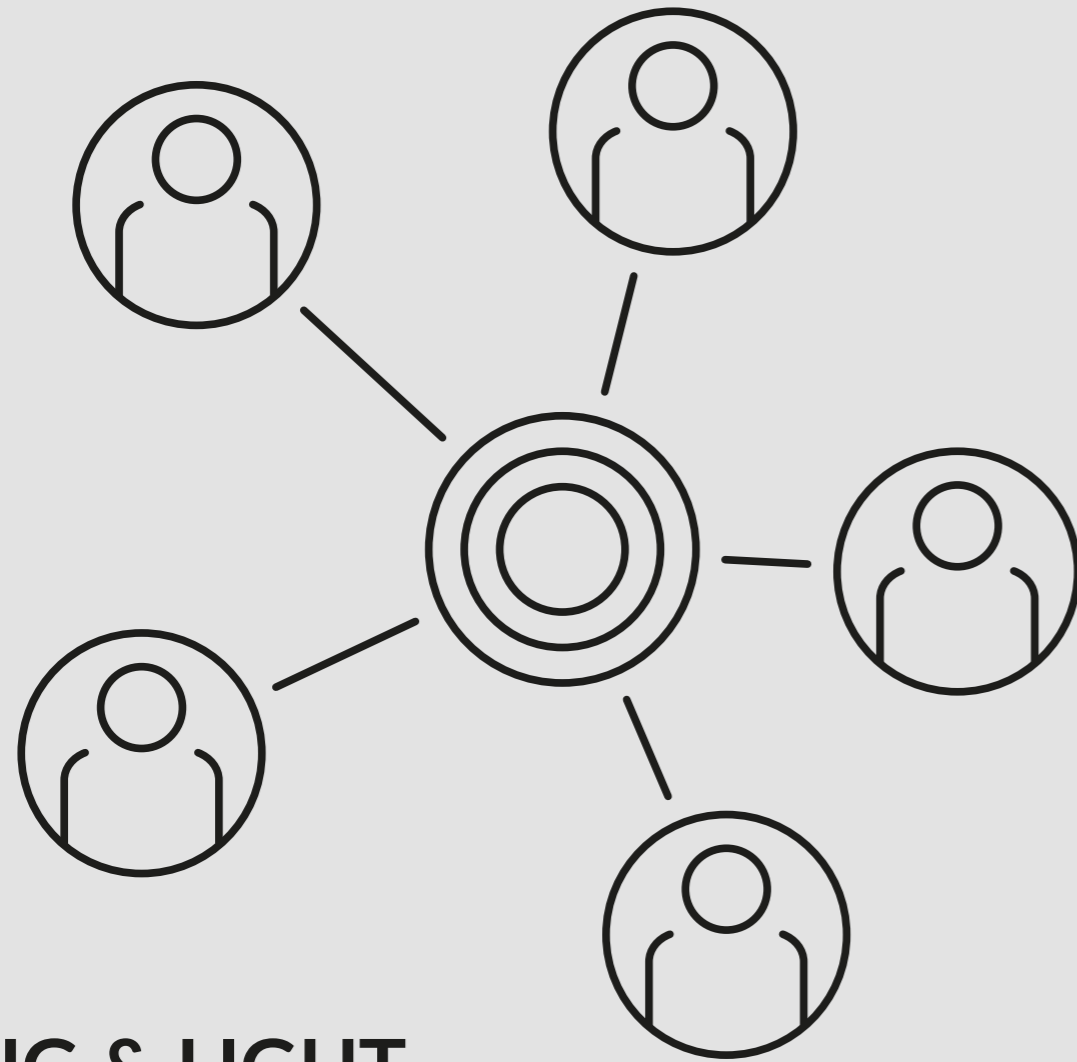

PLUG & LIGHT— OPEN NETWORK

In collaboration with *Gira*, *Jung* and *Brumberg*, *Insta* is paving the way for a new world of lighting design. With flexibility in planning and with easy and safe installation, interior lighting has been redefined and its control has become incredibly easy.

For the commercial launch of *Plug & Light*, the collaboration partners are offering a basic equipment of light sockets and matching luminaire designs: the range is the perfect basis for high-end interior design.

However, *Plug & Light* is not intended to be limited to our design approaches. The innovative and uncomplicated *Plug & Light* principle has been conceived with the future in mind: *Plug & Light*, an extendable platform. Other luminaire and building systems manufacturers are invited to use the system developed by *Insta* to design their own luminaires or light sockets and, as part of the *Plug & Light* network, to co-design the future of interior lighting.

Plug & Light offers switch manufacturers the freedom to combine their switch design with lighting design – functionality guaranteed and matched to interior styles.

For luminaire manufacturers, the light socket forms a unique basis. Ambient lighting that can be flexibly planned and that adapts to both living and room requirements can now be realised in branded luminaire designs.

As the *Plug & Light* system developer and a full-service provider in the OEM sector for decades, *Insta* takes an individual approach to the technical requirements of its partners and gets involved where competence is needed.



Lightsocket Jung LS 990
Brumberg MiniQ wall mounted luminaire | white

LIGHTING THAT FOLLOWS PEOPLE'S NEEDS

The Lichtplanungsbüro (lighting design office) Tobias Link was founded in 1991 in Saarbrücken. Tobias Link and his partner Oliver Link develop customised solutions—lighting systems, objects and installations for international clients and a broad spectrum of application.



Oliver Link

Tobias Link



Light, wine and contemporary architecture:
Weingut Franz Keller in Oberbergen

How did you become the concept designer of *Plug & Light*?

We have been cooperating with *Insta* for a long time. We have created the luminaire *instalight No limit* together, for example. A modular system with which many different lighting solutions can be easily implemented. A successful project. So *Insta* asked if I would like to address the topic of 'light straight from the socket'. —A fantastic assignment!

How did you proceed?

We first created use cases, working our way around the house exploring: where are flush-mounted sockets used? Where—in which positions where switch and switch equipment are installed—does it make sense to use lighting? We have investigated luminous flux: how high is the lumen output that can be produced by an LED that is integrated into a flush-mounted socket and how expedient is it to produce directional or diffused light with it? And: what do I wish to achieve in doing so? What possible applications are there?

We developed two options that could be plugged onto the light socket: a classic spotlight and a luminaire with asymmetrical beam angle, the wall light.

How did you come up with the idea of a three-ring plug-in solution, which is also a *Plug & Light* trademark?

The construction of the light socket is inspired by a design concept for a desk lamp that I implicitly wanted to implement: the base, arm and head of the luminaire should be available in various finishes and colours using a simple design language. Customers should be able to configure the luminaire according to their wishes: glossy black base, matt black arm, copper-coloured head or similar. The assembly of the luminaire should be possible without any tools. So I developed the plug-in idea with the three concentric magnetic rings. The luminaire has never been produced—but I have always looked for possible applications for this innovative plug-in idea. This opportunity came with *Plug & Light*. It fits perfectly and has now been modified and perfected.

Where in the living room are the luminaires best used?

Everywhere!—During the development phase we illuminated an entire hotel room as an example: the asymmetrical wall light allows for a glare-free illumination of the corridor, immediately creating

a cosy atmosphere! The wall light can also be applied in the bathroom at the washstand or mirror. If you turn it 180° to the ceiling, it functions also as an uplight. The spotlight becomes the perfect bedside reading light and is equally suitable for the ceiling or as a spot. You can illuminate an entire hotel room with it.

What advantages does *Plug & Light* offer from a design perspective?

The entire light installation of a building is now possible in a consistent design language and with uniform materials—from the switch to the wall lights to the ceiling lights. This is completely new!—A switch system is always present in the living room anyway. The fact that matching luminaires and installation parts are now available without a change of equipment responds to the wishes of many architects and designers. —Because that means more design freedom for planning interiors. A new architectural quality.

Plug & Light creates flexibility on many levels ...

For example also in planning and assembly. It was important that the electricians favour the system. It is often the electricians who choose the switch design for a home. This is what interests them: how can I install everything as quickly as possible? —If the situation is unclear, the electrician can just simply install a few more light sockets, for example in the kitchen. Maybe more light is needed there at times. One is flexible without having to reuse the drill. Of course, awareness for the possibilities using the *Plug & Light* system is necessary. The fact that a new flexibility comes into being is an option not a must. The entire handling is very simple. Thanks to a magnet on the light socket, a pendant light can replace a spotlight within seconds and without tools—conventional lighting would require time-consuming installation.



Lighting scenes for spa and garage at a Swiss property

The entire light installation of a building is now possible in a consistent design language and with uniform materials—from the switch to the wall lights to the ceiling lights. This is completely new!

In the future, you can easily set new accents in your hotel room, office or home ...

Yes, that's very handy. You only have to remove the light. If new attachments are added, you can create a completely new style or atmosphere in the interior in no time at all.

What other projects are you currently working on?

We are currently working on lighting projects for several shopping centres located in Cologne, Munich, Chemnitz, and Leipzig. We also have projects in the luxury and spa hotel sector. An exciting project in this sector is currently in the pipeline near Frankfurt. Light has many aspects—in the area of artistic application of light, we are currently designing a façade mise-en-scène for the Grand Theatre of the City of Luxembourg. There are also several projects on a smaller scale such as the municipal park in Merzig, where we are treading completely new paths.

What general trends do you see in the lighting sector?

Light makes it bright—used to be the motto. At some point there came a phase in which we concentrated on saving energy with LEDs. That has now been launched worldwide. Now it's all about customised lighting in a wide variety of sectors. The light follows the needs of the people according to the situation. Coloured lighting is becoming an issue in medicine—for example with Alzheimer's patients. In nursing homes, where different areas of a building are bathed in light to provide orientation. Lighting concepts are becoming more specific. They are becoming more refined, more differentiated. A lot will happen in the next few years: it will be possible to adjust the colour temperature directly at the luminaire so that its wavelengths become shorter, for example—which facilitates reading for older people.

So, lighting designers will have an essential task in the future ...

The work spectrum is very broad. We develop lighting concepts from restrained, from focused on biological needs, to opulently staged as in the theatre. We're partly interior designers; we know our way around lighting technology. But we also look at the psychological aspects. Lighting design is not just about complying with DIN values and ensuring that it looks good. It is also about light climate. We want people to feel good. It has to be right, adapted to the respective application purpose. This topic also played a decisive role with *Plug & Light*: do people need all this? How do they feel with this lighting when it's applied in different ways? We were mainly interested in the effect of light in a room. And less in the luminaire. Therefore, the entire design is very reduced. The basic approach was as follows: reduction of formal language, multiplication of lighting effects in the room. —We cannot touch light. However, it touches us!

—*Plug & Light* gives users the security of directly creating a wonderfully pleasant lighting effect.

PLUG & LIGHT SYSTEM DEVELOPER

Developed by
INSTA

In addition to the light socket, *Insta* has developed light attachments for *Plug & Light* that enable OEM manufacturers to become a part of the *Plug & Light* world—quickly, easily and with high-end products, for example, by marking ready-for-sale products with the OEM label. The *Plug & Light spotlight* is included in the OEM portfolio. Featuring continuously adjustable glare protection, it generates the desired lighting situation at the wall or ceiling. The design of the *Plug & Light wall light* is reminiscent of a traditional switch. Asymmetrical light distribution provides homogenous surface illumination. Offering countless extension options, the Light Engine by *Insta* is the universal attachment in the *Plug & Light* system. It will be available as a finished product or can be used as a basis for third-party luminaire design. All light attachments by *Insta* provide guaranteed, 100 % flicker-free light across the entire dimming spectrum and can be rotated by 360° without a limit stop.

At *Insta*, light and building systems technology come from a single source. Founded in 1970, the electronics technology centre and its 600 employees develop and produce innovative solutions for smart homes and buildings, for modern architectural lighting. Since June 2018, *Insta* has been one of the top innovators for German SMEs.

The range of systems includes connected building systems for heating, ventilation and air-conditioning, for shutter management and for customised LED lighting for interior and exterior spaces including all necessary controls.

Insta's unique know-how in the field of lighting and in the development of international standards has been brought to bear in the *Plug & Light* system. With *Plug & Light*, a genuine innovation has entered the global lighting design stage: as a systems developer, the company based in Lüdenscheid, Germany, creates new possibilities in interior lighting.



Light socket Gira E2

The light socket is available in the *Gira E2* and *Esprit* ranges, as well as in the *Jung LS 990*, *LS Zero* and *A creation* ranges.

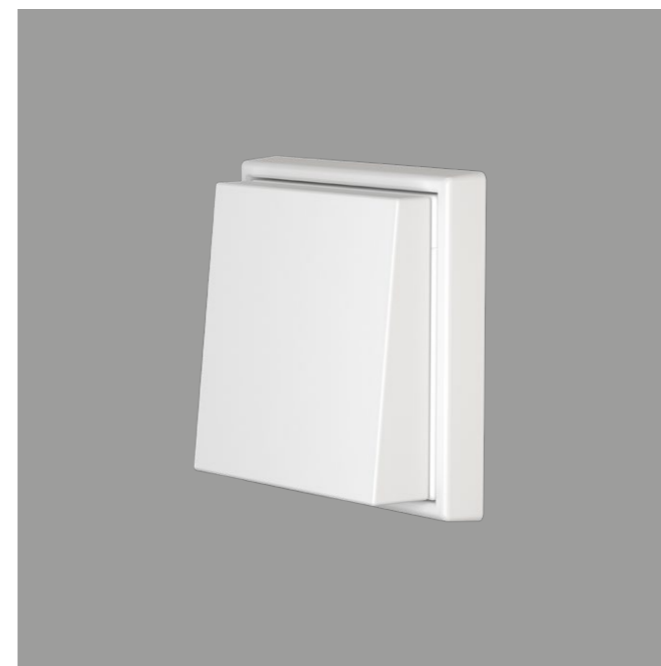

Floodlight Jung LS 990



Spotlight Gira E2

Luminaires from *Insta* are available in the same colours as the switch ranges. Monochrome and warm-dim.

“For *Insta*, *Plug & Light* is a very special system. With this concept, we have created an innovation that meets current market requirements—and that matches *Insta’s* core competencies. It was extremely important to us to strike the perfect balance between light and product design, and to do that in a way that will delight architects, lighting designers and consumers alike. *Plug & Light* is easy to understand and operate. It can be perfectly integrated into existing designs.”

Light socket Gira Esprit



WE ARE RESPONSIBLE FOR THE FUTURE

Featured by
GIRA

Gira integrates the *Plug & Light* system into its *System 55* switch platform and will make the light socket, the *wall light* and the *spotlight* available to the market in, among others, the *Gira E2* and *Gira Esprit* range of switches.

Founded in 1905 by Gustav and Richard Giersiepen, *Gira* positions itself in an international context as one of the leading full-range suppliers of intelligent system solutions, both for electromechanical and digitally connected building control systems. Since its founding, the family-run company has shaped the world of electro-installation with its multiple patented solutions. With its many innovations, *Gira* has significantly influenced the field of building digitisation. *Gira's* products and solutions exemplify German engineering and are synonymous with 'Made in Germany' quality and with perfection in form and function. What's more, *Gira's* products make life easier, safer and more comfortable. Thanks to both the special technological know-how and

distinctive inventive talent of its employees, *Gira* has been able, time and again, to impress with its pioneering achievements, innovative solutions and exciting applications. More than 130 engineers from different disciplines, from software developers through to mechanical engineers, guarantee high-quality innovation in product development and manufacturing. *Gira* challenges traditional ways and methods and develops fundamentally new approaches: the perfect basis for developing future solutions today. *Gira* has always combined the highest standards in product functionality and reliability with beautiful, upmarket design. The company develops the good form of its products from the interplay of design, function, technical innovation and emotion: the only way to make design and function easy and intuitive for users. Many internationally renowned design awards, including the *iF design award*, the *Red Dot Design Award*, the *German Design Award* and the *Iconic Awards*, are testament to *Gira's* extraordinary design quality.

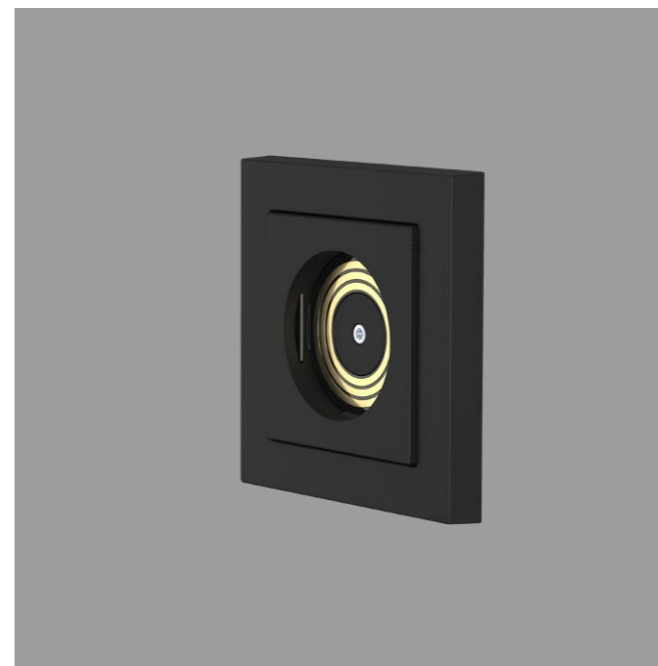

Light socket Gira E2

The covers of the *Gira E2* and *Gira Esprit* ranges are available in white and black matt.

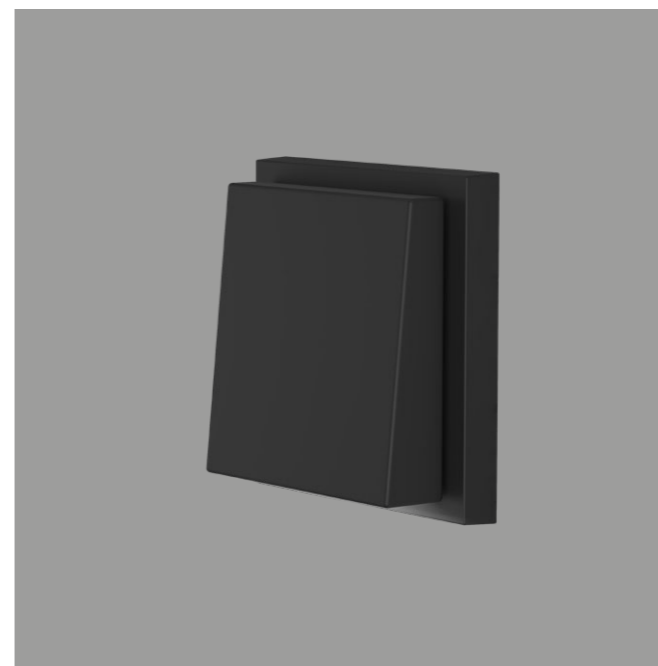

Floodlight Gira E2

Plug & Light floodlight in the *Gira E2* and *Gira Esprit* ranges, available in white and black matt. Dim.



Spotlight Gira E2

Plug & Light spotlight in the *Gira E2* and *Gira Esprit* ranges, available in white and black matt. Dim and warm-dim.

“Gira has perfected the art of integrating the most diverse functions and systems into the world of switch design. With *Plug & Light*, a new dimension has been added. Our *System 55* is the platform that, with its diverse switch programmes, meets the varying requirements of different forms of living and interiors. With *Plug & Light* in the *Gira* switch design, we create even more design options.”



PROGRESS AS TRADITION

Featured by
JUNG

From traditional electro-installation through to state-of-the-art building technology, products from Jung are durable and precisely finished, down to the smallest detail. Jung provides smart and energy-efficient solutions featuring timeless design and cutting-edge technology for modern work environments, for stylish home interiors and for the hospitality sector. Jung has included Plug & Light in various colours of its LS 990, LS Zero, A Creation, A 550 and A Flow switch series. Light socket, wall light and spotlight are available in matching colours.

Jung is a premium supplier of modern building technology systems. Switches, sockets, dimmers, monitoring devices and systems for controlling functions in both private and commercial environments are included in the portfolio of this traditional, medium-sized company. Established in 1912, the mission that led to the company's founding is still the main driver behind product development: Jung designs and develops pioneering and timeless products and systems that make life more comfortable. Switches and applications by Jung can be tailored to individual requirements. They are produced in the company's two facilities, located in the German towns of

Schalksmühle and Lünen, for which, in 2011, the company received the 'Made in Germany' certificate from TÜV Nord (Technical Inspection Association). Firmly rooted in the region and a reliable employer for many decades, Jung is known internationally for the consistently high quality of its products. As a responsible manufacturer, Jung places great importance on sustainable and energy-efficient production.

Jung expertly combines sophisticated design with the ambition to create advanced solutions, from traditional electrical installations to intelligent building technology. From the very beginning, strategic thinking and proactive, forward-looking management have defined the business. The founder's grandson, Harald Jung, manages the company, together with his two colleagues, Martin Herms and Michael Eyrich-Ravens. The business is still guided by its founding father's principle: 'progress as tradition'. A principle that, for more than 100 years, has guaranteed international market success. Also contributing to this success is the team spirit of Jung's 1,200 employees in Germany and in the 17 subsidiaries and 67 representations in Europe, the US, the Middle East and Asia.



Light socket Jung LS 990

The covers available in the LS 990, LS Zero and A creation ranges. LS 990 and LS Zero come in white, black, aluminium (lacquer finish) and stainless steel (lacquer finish); A creation available in white, black and aluminium.



Floodlight Jung LS 990

Plug & Light floodlight, available in the LS 990, LS Zero and A creation ranges. Dim and warm-dim.



Spotlight Jung LS 990

Plug & Light spotlight, available in the LS 990, LS Zero and A creation ranges. Dim and warm-dim.

“Since 1912, *Jung* has been known for skilfully combining sophisticated design with innovation. With *Plug & Light*, a genuine innovation has entered the lighting market. Providing the light socket in the *Jung* switch design was, therefore, an obvious step for us.”

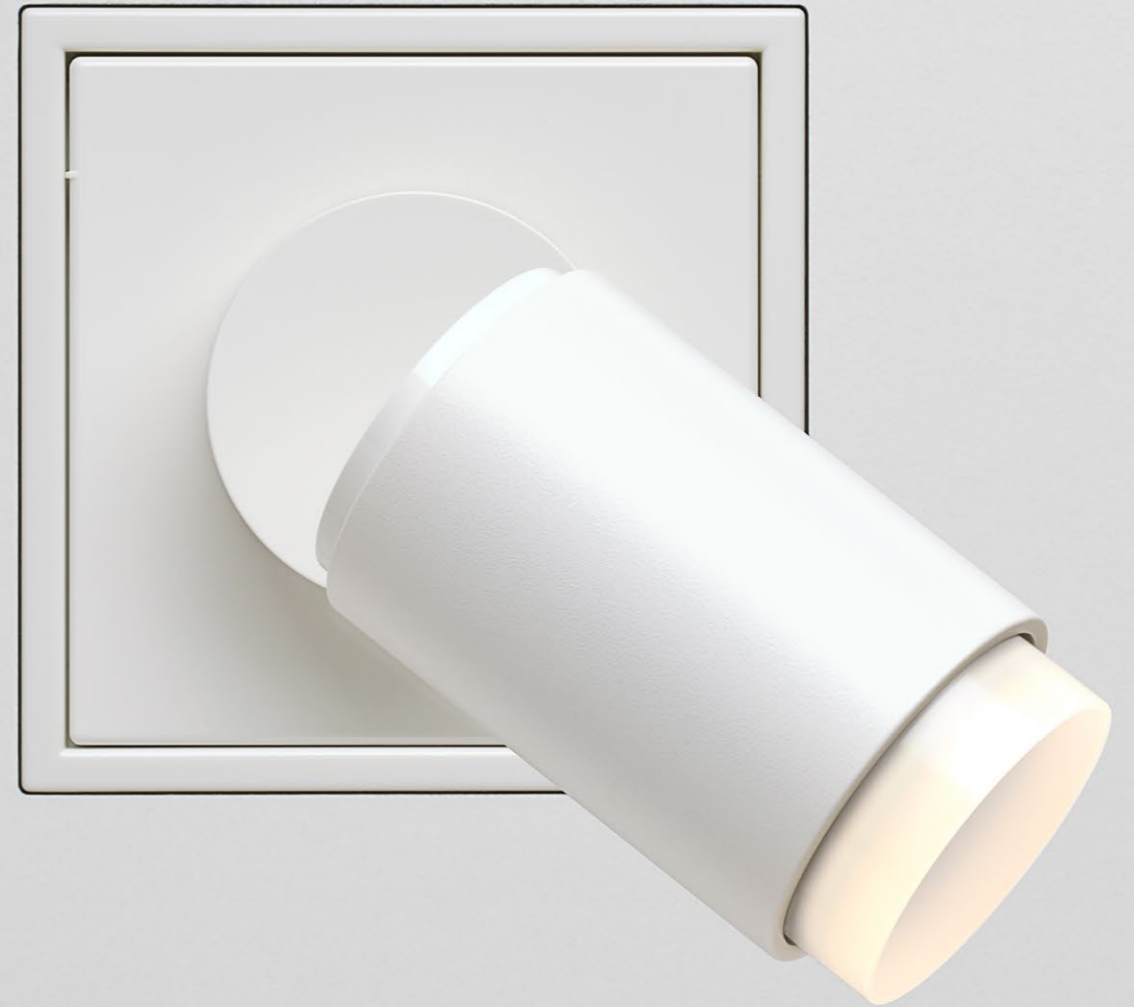

LIGHT. FOR GENERATIONS.

Plug & Light Member

BRUMBERG

As a *Plug & Light* partner, *Brumberg* has developed five decorative ranges of luminaires for the system's commercial launch, including ceiling, wall and pendant luminaires: with *MiniQ*, *Bowl*, *Grammo*, *Circle* and *LS Cone & Straight*, *Brumberg* offers a large portfolio of high-end luminaire families that provide perfect accent lighting in both homes and contract environments.

Brumberg has been developing lighting systems and luminaires since 1873. Among the company's first products were petroleum lamps, developed and produced by *Brumberg*. Today, *Brumberg* is one of the leading German producers of luminaires. The family-run company considers itself a pioneer in the field of innovative and future-oriented products. Superb design, a wide range of functions, cutting-edge technology, energy efficiency and a focus on LED solutions characterise *Brumberg's* luminaires for indoor and outdoor applications.

Ceiling, wall and floor lights—*Brumberg* offers a comprehensive spectrum of high-end luminaires and light-control systems for various applications in commercial and residential lighting: for industry and the skilled trades, for offices and communication, for the home and living sector, for the shops and retail sector and for the hotel and hospitality industries. *Brumberg's* products and services have always been based on a special commitment: *Brumberg* listens to its customers and identifies with their needs and requirements. With this approach, the company, based in the Sauerland region of Germany, always finds the perfect solution and delivers excellent results, achieved in collaboration with its clients: *Light. For generations.*



Bowl: ceiling, pendant and wall light



Circle: ceiling light

LS Cone: wall light

LS Straight: wall light



Grammo: ceiling, pendant and wall light



MiniQ: pendant, wall and ceiling light

All lighting series are available in the colours white (RAL 9010), black (RAL 9005) and white aluminium (RAL 9006).

“Freedom in design. Flexibility. Simplicity. These three qualities were our drivers for developing luminaires for this application. The simple and safe installation and the reliable functionality of the control features are unique. And all that comes with maximum flexibility for the user. Therefore, for *Brumberg*, *Plug & Light* is a system with great future potential.”

Brumberg MiniQ ceiling



IMPRINT

Published by

Insta GmbH
Hohe Steinert 10
58509 Lüdenscheid / Germany

T +49 2351 936-0

sales@plugandlight.de
service@plugandlight.de
press@plugandlight.de

insta.de

Design

studiopanorama.de

Text

welcome design. PR | Communiucation
welcome@welcomedesign-pr.com
welcomedesign-pr.com

Printed by

Rehms Druck GmbH
info@rehmsdruck.de
rehmsdruck.de

REIMAGINING LIGHT



DEVELOPED BY
INSTA

FEATURED BY
GIRA & JUNG

MEMBER
BRUMBERG