

Issue:
10.07.2008

Room actuator Order-No. 2162 00



Content

1	<u>Product definition</u>	<u>3</u>
1.1	Product catalogue	3
1.2	Function	3
2	<u>Fitting, electrical connection and operation</u>	<u>5</u>
2.1	Safety instructions	5
2.2	Device components	6
2.3	Fitting and electrical connection	7
2.4	Commissioning	12
2.5	Operation	15
3	<u>Technical data</u>	<u>21</u>
4	<u>Software information</u>	<u>23</u>
4.1	Software specification	23
4.2	"Switching, blind, valve 20B3x1" software	24
4.2.1	Scope of functions	24
4.2.2	Software information	26
4.2.3	Object table	27
4.2.4	Functional description	38
4.2.4.1	Description of channel-independent functions	38
4.2.4.1.1	General channel-independent functions	38
4.2.4.1.2	Channel-independent functions for relay switching outputs	46
4.2.4.1.3	Channel-independent functions for blind outputs	49
4.2.4.1.4	Channel-independent functions for valve outputs	53
4.2.4.2	Channel-oriented functional description	59
4.2.4.2.1	Functional description for relay switching outputs	59
4.2.4.2.2	Functional description for blind outputs	83
4.2.4.2.3	Functional description for valve outputs	141
4.2.4.3	Priorities	163
4.2.4.4	State as supplied	164
4.2.5	Parameters	165
5	<u>Appendix</u>	<u>231</u>
5.1	Index	231

1 Product definition

1.1 Product catalogue

Product name: Room actuator 230 V DRA

Use: Actuator

Design: Rail-mounted device

Order-No. 2162 00

1.2 Function

The room actuator is used to control electrical loads of three different building systems that are typically used in a residential, office or hotel room:

The first four relay outputs of the room actuator can be set in the ETS software configuration either to blinds operation or alternatively to switching operation; mixed operation of these two modes of operation is also possible on the device. In blinds operation the relay contacts of the room actuator can be used to control electrically driven blinds, shutters, awnings, venting louvers or similar curtains for 230 V AC mains voltage. Alternatively, the actuator can switch electrical loads such as lighting systems in switching operation. The relay contacts are bistable, which means that the last switching state set remains unchanged even in the event of a mains voltage failure.

Furthermore, the room actuator has two additional electronic switching outputs, which allow silent control of electrothermal valve drives for heating or cooling systems. Up to 4 electrothermal valve drives can be connected to each of these electronic outputs, which are protected against overload and short-circuit.

By combining the functions of the room actuator's outputs, in many cases it is possible to plan and execute electrical installations on a room-specific basis.

The functionalities that can be preset with the ETS independently for each output channel in blinds operation include, for instance, separately parameterizable travelling times, enlarged feedback functions, assignment to up to 5 different safety functions, an extensive sun protection function, and incorporation into scenes or forced-position applications. Centralized control of all blind outputs is also possible.

In switching operation the functionalities for each output include, for example, extensive time functions, logic operations, scenes, disabling functions or alternatively forced positions, expanded feedback telegrams, cyclical monitoring of the incoming telegrams and an operating hours counter. Here, too central switching of all switching outputs is possible.

Each of the electronic switching outputs has the following scope of functions: conversion of constant command value telegrams into a pulse-width modulated output signal (PWM). This provides quasi-constant activation of the the connected valve drives. Alternatively, conversion of switching command values. Status messaging for valve position and cyclical monitoring of the command value telegrams. Emergency operation in the event of bus voltage failure or bus and mains voltage return and forced position via bus telegram in summer and winter mode. Alarm message in case of short-circuit or overload of the switching output and anti-sticking protection for the valves. Valve drives that are closed or open when deenergized can be connected.

What is more, the room actuator monitors the mains voltage and makes it possible to transmit an alarm message to the bus in the event of a fault. The status messages "all valves closed" and "largest command value" can be transmitted to the bus in common for the two electronic switching outputs for further processing or displaying the information on other bus devices.

The controls (4 pushbuttons) on the front panel of the device permit switching the relays and also the electronic switching outputs on and off by hand even without bus voltage or in a non-programmed state. This feature permits fast checking of connected loads for proper functioning.

ETS3.0d is recommended for configuration and commissioning of the device. The advantages with regard to downloading (shorter loading times) and parameter programming are available only if this new ETS patch version or later versions are used. For ETS2 and older versions of ETS3, a separate product database is available.

The room actuator has its own mains voltage connection that is independent of the connected drives or loads. For activation of the outputs the 230 V mains voltage must always be switched on. The device electronics (BCU with application program) are supplied with power from the bus or from the mains. The device is designed for being mounted on DIN rails in closed compact boxes or in power distributions in fixed installations in dry rooms.

2 Fitting, electrical connection and operation

2.1 Safety instructions

Electrical equipment must be installed and fitted by qualified electricians. The applicable accident prevention regulations must be observed.

Failure to observe the instructions may cause damage to the device and result in fire and other hazards.

Disconnect (switch off miniature circuit-breaker) before working on the device or exchanging the connected loads, otherwise there is a danger of electric shocks.

The actuator is not suitable for disconnection from supply voltage.

Do not connect mains voltage and SELV/PELV circuits to the same actuator.

Do not connect any three-phase motors.

For parallel connection of several drives to an output it is indispensable to observe the corresponding instructions of the manufacturers. There is otherwise risk of irreparable damage to the drives.

Use only curtains with mechanical or electronic limit switches. Check the limit switches for correct adjustment.

Connect only electrothermal valve drives to the electronic switching outputs. Do not connect any inductive or capacitive loads.

Do not operate electrothermal valve drives with DC.



During installation, adequate insulation between the mains voltage and the bus must be ensured! A minimum distance of at least 4 mm must be maintained between bus conductors and mains voltage cores.

The device may not be opened or operated outside the technical specifications.

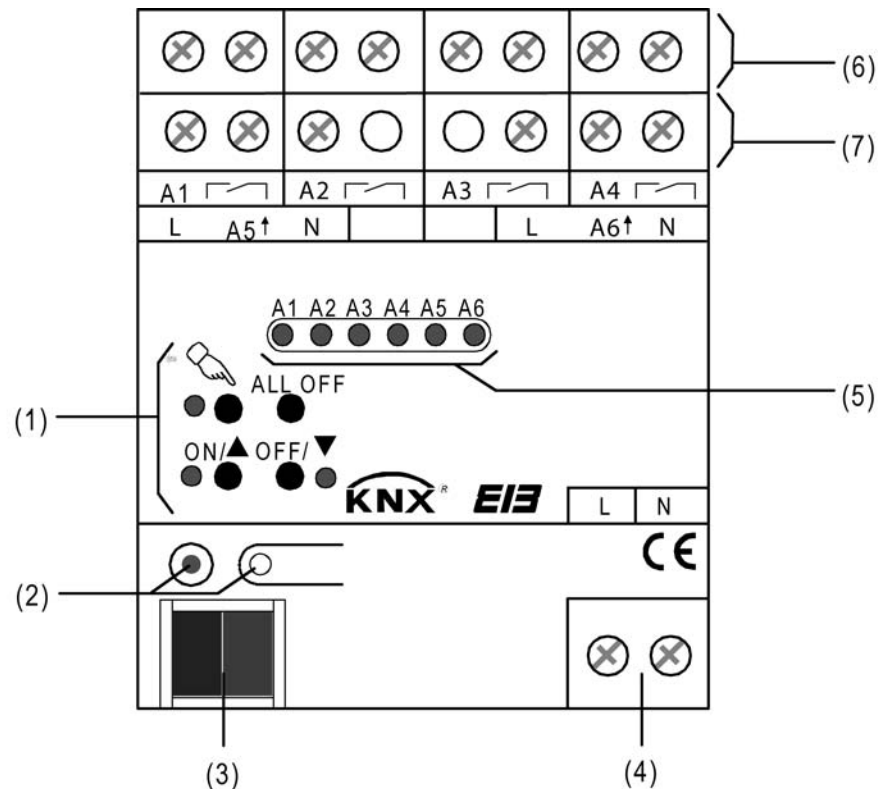
2.2 Device components



picture 1: Device components

- (1) Button field for manual control
- (2) Programming button and programming LED (red). The programming LED flashes slowly when the safe-state mode is active.
- (3) KNX/EIB bus connection
- (4) Mains voltage terminal for power supply to the device electronics
- (5) Status LEDs (red) for the outputs with switching state indication (1 LED per output):
 LED off: output switched off (deenergized)
 LED on: output switched on (energized)
 LED flashing slowly: output in manual control
 LED flashing quickly: output disabled via manual control
 A switched-on status LED indicates...
 ...in blinds operation: Move up "▲" for A1 and A3 or move down "▼" for A2 and A4,
 ...for electronic switching outputs: Output energized. The LEDs indicate the switch-on and switch-off state of the pulse-width modulation for manual control.
- (6) Screw terminals (Ax, ) for connecting the drives for the blinds, shutters, awnings or venting louvers in blinds operation or for the electrical loads in switching operation.
- (7) Screw terminals (Ax, ) for connecting the electrothermal valve drives (valve outputs).

Dimensions:

Width (W): 72 mm (4 modules) / height (H): 90 mm / depth (D): 70 mm

2.3 Fitting and electrical connection



DANGER!

Electrical shock when live parts are touched.

Electrical shocks can be fatal.

Before working on the device, disconnect the supply voltage and cover up live parts in the vicinity.



DANGER!

Electrical shock on all SELV/PELV circuits when loads for mains voltage and SELV/PELV are both connected to an actuator.

Electrical shocks can be fatal. Danger of destruction of all devices connected to the SELV/PELV.

Do not connect any loads for SELV/PELV/FELV!



CAUTION!

Incorrect control of the load in case of incorrect device configuration in the ETS!

Danger of destruction of the connected blind drives in blinds operation.

Adapt the device configuration (channel definition) in the ETS to the connected load!





CAUTION!

Danger of destruction if several drives are connected in parallel to one output.

Limit switch contacts can weld together and drives, curtains and the blind actuator can be destroyed.

Observe the manufacturer's instructions and use cutoff relays, if necessary.

Fitting

- Fit the device by snapping it onto a mounting rail in acc. with DIN EN 607515. The screw terminals for connection of the motors should be at the top.
-  A KNX/EIB data rail is not required.
-  Observe the temperature range (-5 °C ...+45 °C) and ensure sufficient cooling, if necessary.

Connecting the power supply for the device electronics

- Connect the bus (standard bus terminal) and the mains voltage as shown in Fig. (see picture 2).

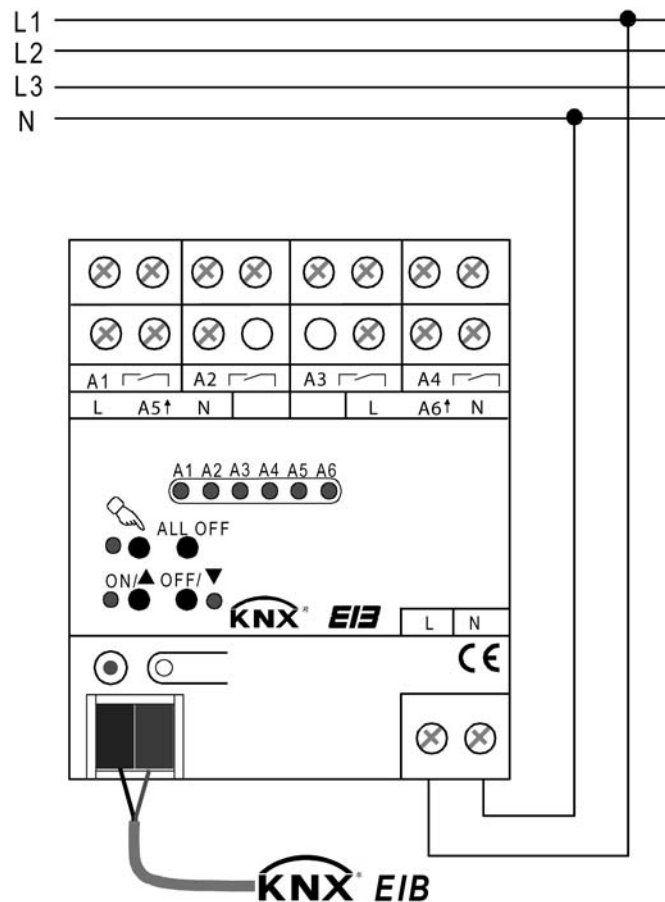

picture 2: Electrical connection of mains voltage

- i** The device can be used with different phase conductors (L1, L2, L3).
- i** For actuation of the outputs – even in the manual control mode – the mains supply must be on. The device electronics (BCU with application program) are supplied with power from the bus or from the mains.

Connect device for 230 V drive motors in blinds operation

In blinds operation, each pair of adjacent relay outputs (A1...A4) forms a blind output. In each case the left-hand relay output (A1, A3) is intended for the UP direction (▲), and the right-hand load output (A2, A4) for the DOWN direction (▼).

The room actuator must be set in the ETS to blinds operation for the corresponding output channel (1 x blind output) (this setting also corresponds to the state as supplied).

- Connect the drives as shown in the wiring example (see picture 3).

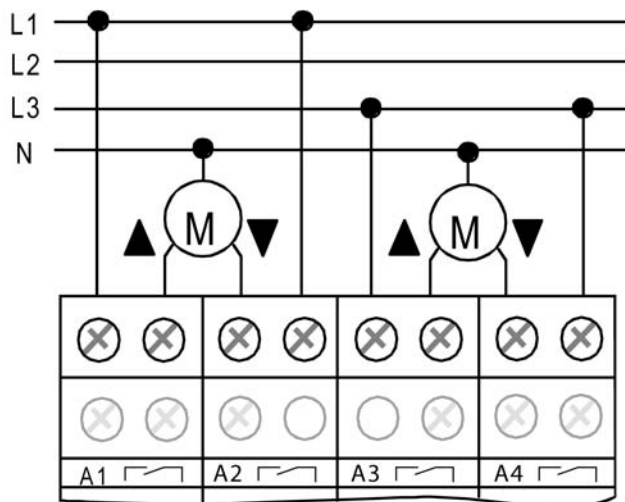

picture 3: Electrical connection for 230 V drives in blinds operation

- i** Observe the admissible load ratings (cf. 'Technical data').
- i** The device can be used with different phase conductors (L1, L2, L3).
- i** The travel directions "UP - ▲" and "DOWN - ▼" are mutually interlocked via the device software.
- i** Venting louvers must be connected in such a way that they open in travel direction "UP - ▲" and close in travel direction "DOWN - ▼".

Connecting the device for loads in switching operation

In switching operation the outputs A1...A4 can be activated independently of each other.

The room actuator must be set in the ETS to switching operation for the corresponding output channel (2 x switching output).

- Connect the loads as shown in the wiring example (see picture 4)

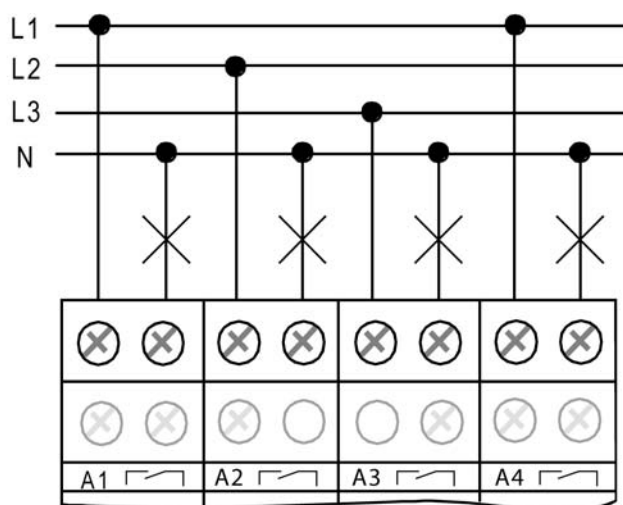

picture 4: Electrical connection for loads in switching operation

- i** Observe the admissible load ratings (see "Technical data").
- i** Various phase conductors (L1, L2, L3) can be connected to the outputs.

- i** Do not connect any three-phase motors.

Connecting the device to electronic switching outputs for 230 V valve drives

The electronic switching outputs A5 and A6 can be activated independently of each other. These outputs are permanently configured as switching outputs for electrothermal valve drives (valve outputs).

- Connect electrothermal valve drives as shown in the wiring example (see picture 5)

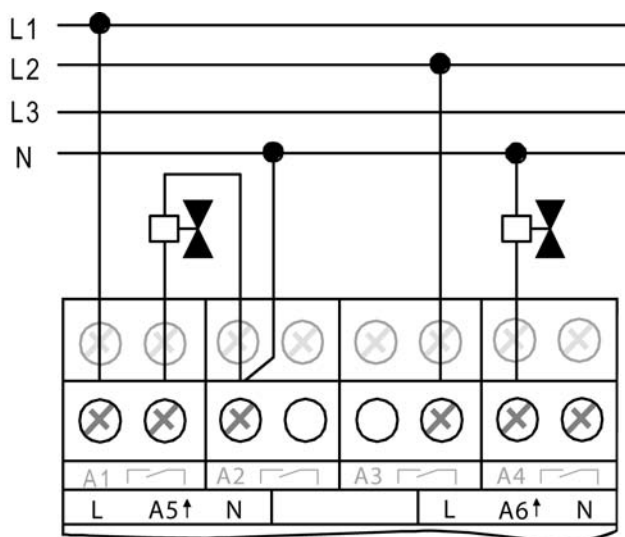

picture 5: Electrical connection for electrothermal valve drives

- i** Observe the admissible load ratings (see "Technical data"). Connect a maximum of 4 electrothermal valve drives per electronic switching output. Do not connect any electric motor-driven valve drives.
- i** When connecting the electrothermal valve drives, pay attention to their direction of action (closed or open in deenergized state), and configure the room actuator in the ETS accordingly. In the state as supplied the direction of action is preset to "closed when deenergized".
- i** Various phase conductors (L1, L2, L3) can be connected to the L terminal of the outputs.
- i** The neutral conductor terminals (marking "N") next to the electronic switching outputs are intended exclusively as connection aids for the neutral conductors of the valve drives. The terminals are not connected in the room actuator to any voltage potential or any other connecting terminal (line terminal posts), and can thus be used optionally (see picture 5).

Installing / removing the protective cap

To protect the bus lines against hazardous voltages, especially in the area of the connecting terminals, a protective cap can be installed.

The cap is installed with the bus terminal in place and the connected bus line led out at the rear.

- To install the cap: Slide the cap over the bus connecting terminal until you feel it engage (see picture 6).
- To remove the cap: Remove the cap by pressing the sides slightly and by pulling it out to the front (see picture 6).

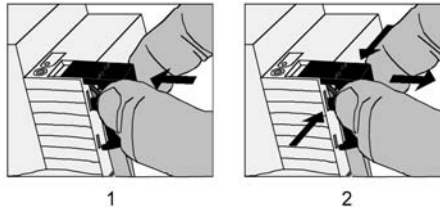

picture 6: Installing / removing the protective cap for the bus connection

2.4 Commissioning

After installation of the actuator and connection of the bus line, the mains supply and of all electrical loads, the device can be put into operation. For blinds operation only, special commissioning steps have to be performed prior to programming with the ETS. The following procedure is generally recommended...



DANGER!

Electrical shock on contact with live parts in the fitting environment.

Electrical shocks can be fatal.

Before working on the device, disconnect the supply voltage and cover up live parts in the vicinity.



CAUTION!

Incorrect control of the load in case of incorrect device configuration in the ETS!

Danger of destruction of the connected blind drives in blinds operation.

Adapt the device configuration (channel definition) in the ETS to the connected load!

Measuring the travelling times

For the purpose of positioning blinds, shutters and awnings or for adjusting the opening angle of venting louvers, the actuator needs accurate information about the maximum travelling time.

Switch on the mains supply.

- If not yet done, move the curtain into the upper end position (open venting louver completely).
The upper limit-stop position is reached (venting louver opened).
 - Start the measuring time and move the curtain by manual control into the lower end position (close the venting louver completely).
 - Stop the time measurement when the lower limit (when the completely closed) position is reached.
 - Enter the measured value in the ETS (cf. "software description").
- i** It is recommended to perform several time measurements and to take the average of these values.
- i** The travelling time can also be determined after commissioning with the ETS (bus operation).

Measuring the travelling time extension

When travelling upwards, blinds or shutters have a tendency of moving more slowly due to their own weight or to external physical influences (e.g. temperature, wind, etc.). The same applies to venting louvers where opening may take longer than closing.

For this reason, the room actuator takes the parameterized travelling time extension into account when moving upwards or when opening the louvers (MOVE operation / positioning). The extension is computed as a percentage of the travelling times in both directions.

The curtain (venting louver) must be in the lower end position (venting louver closed). Switch on the mains supply.

- If not yet done, move the curtain into the lower end position (close venting louver completely).
Lower end position reached (venting louver closed).
- Start the measuring time and move the curtain by manual control into the upper end position (open the venting louver completely).
- Stop the time measurement when the upper limit (the completely open) position is reached.

- Express the measured value as a percentage of the determined curtain travelling time and enter the value in the ETS (cf. "software description").
- i** It is recommended to perform several time measurements and to take the average of these values.
- i** The travelling time extension can also be determined after commissioning with the ETS (bus operation).

Measuring the slat moving time (only for blinds in blinds operation)

In the case of blinds with slats, the slat moving time is for technical reasons part of the overall travelling time of the curtain. The slat moving time is the time required for a movement between the slat positions "closed – 100 %" and "open – 0 %". In order to compute the opening angle of the slats, the actuator needs an information about the slat moving time.

The slats must be completely closed (as in case of downward travel of the blind).

Switch on the mains supply.

- Start the measuring time and open the slats completely by manual control (as in case of upward travel of the blind).
- Take the measuring time when the completely open position is reached.
- Enter the measured value in the ETS (cf. "software description").
- i** It is recommended to perform several time measurements and to take the average of these values.
- i** The slat moving time can also be determined after commissioning with the ETS (bus operation).

Commissioning with the ETS

Before programming the application program and the parameters with the ETS, it must be ensured that the output assignment parameter configurations (channel definitions) correspond to the electric loads connected to the actuator.

- Switch on bus voltage.
Check: the red programming LED must light up when the programming button is pressed. Switching on the bus voltage causes the actuator carry out the "Behaviour after bus or mains voltage return" configured in the ETS. In the state as supplied, this behaviour is set as follows for the outputs...
A1...A4 (blind outputs): Stop drives,
A5 & A6 (valve outputs): Close valves. (Valve direction of action: deenergized closed = outputs OFF).
- Programming the physical address and the application data with the ETS.
- i** When the mains supply is on, the outputs of the actuator can be switched manually even if there is no bus voltage or if the actuator is not yet programmed. Due to this feature, the loads or drives connected to the individual outputs can be checked for proper functioning already during building site operation.

Performing a reference travel (optional only in blinds operation)

The room actuator can approach newly preset curtain or louver positions only if the current positions are known. For this purpose, each output must be given the opportunity to synchronize itself whenever the supply voltage is switched on or after every ETS programming run (physical address, application program). The synchronization is performed by means of the reference travel.

Switch on the mains supply.

- If not yet done, move the curtains to the upper end position (open venting louver completely).
- Wait until the output relay has switched off (not only the limit switch of the drive).
The reference travel is terminated.
- ⓘ The room actuator stores the curtain, slat or louver positions temporarily. After each supply voltage failure (failure of the bus voltage and of the mains voltage) or after programming with the ETS, the actuator therefore automatically performs a reference travel for each output before a new position can be approached.
- ⓘ After bus voltage return, the room actuator generates an "invalid position" message for each output which can also be transmitted to the bus, if so parameterized. The message is cancelled (inverted message value) as soon as a reference travel can be performed. In case of automatic end position detection, a travelling time must have been taught beforehand.

2.5 Operation

All outputs of the room actuator can also be operated manually. The button field with 4 function keys and 3 status LEDs on the front panel of the device can be used for setting the following modes of operation...

- Bus control: operation from push-button sensors or other bus devices,
- Temporary manual control: manual control via the button field, automatic return to bus operation,
- Permanent manual control: exclusively manual control of the device via the button field, return to bus operation only after manual control is aborted manually.

i The operating modes can be enabled or disabled by parameter settings in the ETS.

i When manual control is active, the outputs cannot be controlled via the bus.

i Manual control is possible only while the actuator is supplied with power from the mains. The bus supply voltage does not have to be connected or switched on, however (building site operation).

Manual control is terminated automatically in the event of a mains voltage failure, during any ETS programming process, or in the event of bus voltage return. Manual control cannot be activated or continued during an ETS programming process.

i Manual control in the bus mode can be disabled by a telegram. The manual mode is terminated on activation of the disabling function.

i No manual control of the device is possible if the room actuator is programmed by the ETS with an incorrect application program or if the application program was unloaded. In the state of the actuator as supplied, manual control can be used even before commissioning via the ETS (building site operation).

i Further details concerning manual control, especially with respect to the possible parameter settings and the interaction with other functions of the room actuator can be found in chapter 4, "Software description" of the present documentation.

Controls and indicators for manual control

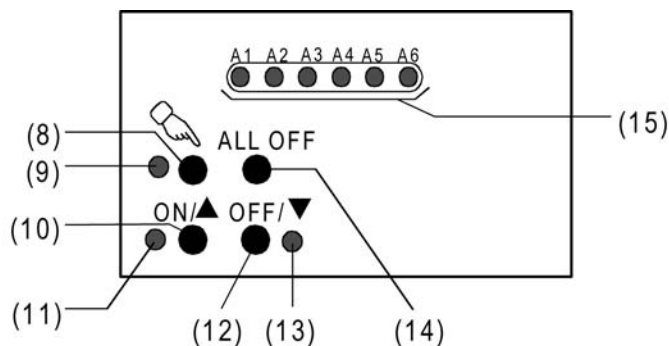

picture 7: Controls and indicators for manual control on the front panel of the device.

- (8) Button : Activation / deactivation of manual control.
- (9) LED : Indicates permanent manual control.
- (10) Button ON/
 - Outputs A1...A4 in blinds operation: Sustained press (> 1 s) = upward travel output / brief press (< 1 s) = output stop
 - Outputs A1...A4 in switching operation: Press = output ON
 - Outputs A5 & A6 (electronic switching outputs): Press = open valve. The pulse-width modulation is also started (cycle time and PWM as configured in the ETS / state as supplied = 15 minutes, 50 % PWM). Each time this button is pressed the pulse phase is started again by switching the output.

- (11) Status LED ON/ ▲:
LED ON in manual control indicates an active travel movement (up / open) or a switched-on output (relay contact closed / electronic switching output energized).
- (12) Button OFF/ ▼:
Outputs A1...A4 in blinds operation: Sustained press (> 1 s) = downward travel output / brief press (< 1 s) = output stop
Outputs A1...A4 in switching operation: Press = output OFF
Outputs A5 & A6 (electronic switching outputs): Press = close valve. The pulse-width modulation is also stopped.
- (13) Status LED OFF/ ▼:
LED ON in manual control indicates an active travel movement (down / close) or a switched-off output (relay contact open / electronic switching output deenergized).
- (14) Button ALL OFF:
All blind drives stop / all switching outputs OFF / all valve close (valve direction of action will be taken into account!). This button only functions in permanent manual control.
- (15) Status LEDs (red) for the outputs with switching state indication (1 LED per output):
LED off: output switched off (deenergized)
LED on: output switched on (energized)
LED flashing slowly: output in manual control
LED flashing quickly: output disabled via manual control
A switched-on status LED indicates...
...in blinds operation: Move up "▲" for A1 and A3 or move down "▼" for A2 and A4,
...for electronic switching outputs: Output energized. The LEDs indicate the switch-on and switch-off state of the pulse-width modulation for manual control.

- i** When operating an electronic switching output (A5 & A6) using the buttons "ON/▲", "OFF/▼" or "ALL OFF", the valve direction of action configured in the ETS is always taken into account. Thus the actuator observes whether a valve has to be energized or not for closing or opening. This results in the following effect: with valves that are open when deenergized, when the buttons "OFF/▼" or "ALL OFF" (command "close valve") the LED for "ON/ ▲" lights up and the output is energized!
Furthermore, when the button "ON/ ▲" is pressed with valve drives that are opened when deenergized, the PWM is started, which means that in manual control of a valve which is open when deenergized it is not possible to switch the output off permanently (exception: PWM with manual control = 100 %, see following note). In the state of the actuator as supplied the direction of action is preset to "closed when deenergized".
- i** In case of manual control (temporary or permanent), the PWM is carried out as soon as a valve is opened. This is also always done for valve outputs that are configured in the ETS as switching (command value 1 bit).
The pulse/pause ratio of the PWM is configured in the ETS specially for manual control in common for outputs A5 & A6. The cycle time of the PWM is also parameterized independent of the channel. In the state as supplied the following values are preset for this:
15 minutes cycle time, 50 % PWM -> switch-on time = switch-off time).
A special feature is that for manual control the PWM can be configured to 100 %. In this case the command "open valve" opens the valve permanently without carrying out pulse-width modulation. Consequently a button command "close valve" closes the valve output permanently. In this case, too the activation of the outputs is performed taking into account the configured valve direction of action.

Priorities

The room actuator distinguishes between different functions that can have an effect on an output. In order to prevent conflicting states, each available function has a certain priority. The function with the higher priority overrides the function with the lower priority.

For blinds operation there are the following priorities...

- 1st priority: manual control (highest priority),
- 2nd priority: forced position,
- 3rd priority: safety function(s),

Priority levels 4 and 5 can be parameterized in the ETS. The options are then...

- 4th priority: sun protection function,
- 5th priority: direct operation via the bus (STEP/MOVE operation, positioning, scenes, central function),

or...

- 4th priority: direct operation via the bus (STEP/MOVE operation, positioning, scenes, central function),
- 5th priority: sun protection function,

or...

- 4th priority: sun protection function and direct operation via the bus (STEP/MOVE operation, positioning, scenes, central function).

For switching operation there are the following priorities...

- 1st priority: manual control (highest priority)
- 2nd priority: forced position or disabling function
- 3rd priority: logic operation
- 4th priority: direct operation via the bus ("switching" object, scenes, central function)

For the valve outputs (electronic switching outputs) there are the following priorities...

- 1st priority: short-circuit / overload (highest priority)
- 2nd priority: manual control
- 3rd priority: anti-sticking protection
- 4th priority: forced position via object
- 5th priority: direct operation via the bus (command value evaluation) / emergency operation

Activating the temporary manual control

Manual control is enabled in the ETS.

- Press the  key briefly (< 1 s).

In blinds operation of A1 & A2: The status LEDs of A1 and A2 flash (LED  remains off).
In switching operation of A1: The status LED of A1 flashes (LED  remains off).

- i** If outputs A1...A4 are parameterized in the ETS to blinds operation, the 2 status LEDs of an output pair (A1/A2, A3/A4) always flash. If outputs A1...A4 are configured to switching operation, only the status LED corresponding to the selected output flashes. Mixed operation with blinds and switching operation on outputs A1...A4 is possible.
The status LED of the electronic switching outputs A5 & A6 always flash separately.
- i** After 5 s without a key-press, the actuator returns automatically to bus operation.

Deactivating temporary manual control

Temporary manual control is active.

- No key-press for 5 s

- or -

- Select all outputs one after another by a brief press of the  button. Thereafter, press the  button again.



- or -

- Shut off the power supply or make a bus reset (bus voltage return).
Temporary manual control is terminated. Status LEDs A1...A6 indicate the valid output status, provided that the actuator's mains voltage is switched on.

i During a deactivation of the temporary manual control mode, the state selected by manual control does not change. If, however, a function with a priority higher than that of the direct operation (e.g. forced position, disabling function or safety function) has been activated via the bus before or during manual control, the actuator executes the function with the higher priority for the outputs concerned. In switching operation, control via the bus is only interlocked, without carrying out the behaviour at the beginning of the forced or disabling function.

Activating permanent manual control

Manual control is enabled in the ETS. Bus operation or temporary manual control is active.

- Press the  key for at least 5 s.
The status LED  is illuminated.
In blinds operation of A1 & A2: The status LEDs of A1 and A2 flash.
In switching operation of A1: The status LED of A1 flashes.
Permanent manual control is active.

Deactivating permanent manual control

Permanent manual control is active.

- Press the  key for at least 5 s.





- or -

- Shut off the power supply or make a bus reset (bus voltage return).
The status LED  goes out. Status LEDs A1...A6 indicate the valid output status, provided that the actuator's mains voltage is switched on.

i Depending on the parameterization of the actuator in the ETS, the outputs will be set to the state last adjusted in the manual mode or to the state internally tracked (direct operation, forced position / disabling function, safety or sun protection position) when the permanent manual mode is shut off.

Controlling an output manually

Manual control (permanent or temporary) is active.

- Select the desired output: Press the  key briefly (if necessary, repeatedly).
The status LED of the selected output A1...A6 flashes. In blinds operation the LEDs of an output pair flash. Additionally the switching state or a travel movement of the selected output is indicated by the status LED "ON/ " or "OFF/ " in the button field. The LED "ON/ " lights up if a switching or valve output is energized.

- Controlling an output by pressing the operating buttons in the button field.

Button ON/ ▲:

Outputs A1...A4 in blinds operation: Sustained press (> 1 s) = upward travel output / brief press (< 1 s) = output stop

Outputs A1...A4 in switching operation: Press = output ON

Outputs A5 & A6 (electronic switching outputs): Press = open valve. The pulse-width modulation is also started (cycle time and PWM as configured in the ETS / state as supplied = 15 minutes, 50 % PWM). Each time this button is pressed the pulse phase is started again by switching the output.

Button OFF/ ▼:

Outputs A1...A4 in blinds operation: Sustained press (> 1 s) = downward travel output / brief press (< 1 s) = output stop

Outputs A1...A4 in switching operation: Press = output OFF

Outputs A5 & A6 (electronic switching outputs): Press = close valve. The pulse-width modulation is also stopped.

The selected output executes the corresponding commands immediately.

- i** In temporary manual control: After running through all of the the outputs, the device leaves manual control when the button  is pressed again.
- i** Depending on the parameter configuration in the ETS, if necessary feedback telegrams are transmitted to the bus via the feedback objects of an output during control, if the bus voltage is switched on.

Controlling all outputs centrally via permanent manual control

Permanent manual control is active:

- Press the ALL OFF key
All blind drives stop. All switching outputs switch OFF. All valves close (valve direction of action is taken into account!).
- i** The "ALL-OFF" function is not available in temporary manual control.

Disabling bus control of individual outputs manually

It is possible to use manual control to disable an output in such a way that it can no longer be activated via the bus even after the end of the manual control.

Permanent manual control is active:

Disabling of the bus control mode must have been enabled in the ETS.

- Select the output: Press the  key briefly (if necessary, repeatedly).
The status LED of the selected output A1...A6 flashes. In blinds operation the LEDs of an output pair flash. Additionally the switching state or a travel movement of the selected output is indicated by the status LED "ON/ ▲" or "OFF/ ▼" in the button field. The LED "ON/ ▲" lights up if a switching or valve output is energized.
- Press the ▲ and the ▼ key simultaneously for at least 5 s.
The output concerned A1...A6 is disabled (no bus operation).
The LEDs of the selected output A1...A6 flash fast. In blinds operation the LEDs of an output pair flash.
- i** An output that has been disabled manually can thereafter only be operated in the permanent manual mode.

- i** If a disabled output is selected in manual control, the LEDs flash twice briefly with a time interval.

Cancelling the disabling of bus control of individual outputs via manual control.

Permanent manual control is active:

Bus control of an output has been disabled previously in permanent manual control.

- Select any desired output that is to be re-enabled: press  button briefly (several times if necessary).
The status LED of the selected output A1...A6 flashes twice briefly with a time interval. In blinds operation the LEDs of an output pair flash. Additionally the switching state or a travel movement of the selected output is indicated by the status LED "ON/ ▲" or "OFF/ ▼" in the button field. The LED "ON/▲" lights up if a switching or valve output is energized.
- Press the ON/ ▲ and OFF/ ▼ buttons simultaneously for at least 5 s.
The selected output is re-enabled (control via the bus is possible again after manual control is deactivated).
The status LED of the selected output A1...A6 flashes slowly.

3 Technical data

Technical data

General

Protection class	IP 20
Safety class	II
Mark of approval	KNX / EIB / VDE
Ambient temperature	-5 ... +45 °C
Storage/transport temperature	-25 ... +70 °C (Storage above +45 °C reduces the lifetime.)
Mounting orientation	as desired (preferably output terminals up)
Minimum distances	none
Fixing type	Snapping onto top hat rails in closed housing (e.g. small distribution board, etc.)

Terminals for mains supply and outputs

Connection mode	Screw terminal
single stranded	0.5 ... 4 mm ²
finely stranded without conductor sleeve	0.35 ... 4 mm ²
finely stranded with conductor sleeve	0.14 ... 2.5 mm ²
Connection loosening torque	max. 0.8 Nm

KNX / EIB supply

KNX medium	TP 1
Commissioning mode	S mode
Rated voltage KNX	DC 21 V ... 32 V SELV
Power consumption KNX	typ. 150 mW
Connection mode KNX	Standard KNX / EIB connection terminals

External supply

Rated voltage AC	AC 230 V / 240 V ~
Mains frequency	50 / 60 Hz
Power loss	max. 6 W

Outputs A1...A4

Contact type	μ contact, potential-free NO contact
Contact rating AC1	16 A
Contact rating AC3	6 A
Contact rating AX (fluorescent lamps)	16 A
Making current	max. 800 A (200μs)
Making current	max. 165 A (20 ms)
Minimum switching current AC	min. 100 mA

Breaking capacity per output (A1...A4)

Ohmic load	3000 W
Capacitive load 16A	max. 140 μF
Blind, fan motors	1380 VA
Lamp loads:	
230/240 V incandescent lamps	3000 W
HV halogen lamps	2500 W
Inductive transformers	1200 VA
Tronic transformers	1500 W
Fluorescent lamps, uncompensated	1000 VA
Fluorescent lamps, parallel compensated	1160 VA (140μF)
Fluorescent lamps, duo circuit	2300 VA (140μF)
Mercury vapour lamps, uncompensated	1000 W
Mercury vapour lamps, parallel compensated	1160 W (140 μF)
Electrical ballast	Type-dependent

The number of electrical ballasts that can be connected depends on the type and manufacturer, and is also dependent on the characteristics of the low-voltage installation network. For this reason, various electrical ballast types are listed below as examples (manufacturer: Osram / as at 01.2007). Max. number per output (for 25,000 switching cycles).

T8 lamps:	
QTP 2 x 58 W	11
T5 lamps:	
QT-FH 4 x 14 W	10
QT-FQ 2 x 54 W	11

Outputs A5 & A6

Output type	Semiconductor (Triac), ε
Switching current	5 mA ... 50 mA
Making current	max. 1.5 A (2 s)
Number of drives per output	max. 4

4 Software information

4.1 Software specification

ETS search paths: - output / binary output, mix / Room actuator 230 V DRA
 - heating, air condition, ventilation / valves / Room actuator 230 V DRA

Build used: TPUART + μ C
 KNX/EIB type class: 3b device with cert. physical layer + stack
 Configuration: S-mode standard
 PEI type: "00"_{Hex} / "0"_{Dec}
 PEI connector: No connector

Application program:

No.	Short description	Name	Version	from screen version
1	Multifunctional switching/blinds application incl. valve control for heating or cooling systems.	Switching, blind, valve 20B301	0.1 for ETS 2 and ETS 3.0a...c	705
		Switching, blind, valve 20B311	1.1 for ETS 3.0 from version d onwards	

4.2 "Switching, blind, valve 20B3x1" software

4.2.1 Scope of functions

General

- Blinds or switching operation for outputs A1...A4 parameterizable. In blinds operation, the outputs A1/A2 and A3/A4 are combined into single blind outputs. Mixed operation on an actuator (for example A1/A2 blind, A3 switching, A4 switching) is possible.
- Two independent electronic switching outputs A5 & A6 for silent control of electrothermal valve drives for heating or cooling systems. Conversion of switching or constant command value telegrams into a switching or pulse-width modulated output signal.
- Behaviour in case of bus voltage failure and bus voltage return as well as after ETS programming presettable for each output.
- Actively transmitting feedback or status messages can be delayed globally after bus voltage return or after ETS programming.
- Manual control of outputs independent of the bus (for instance, building site operation) with LED state indicators. Separate status feedback to the bus for manual control. Manual control can also be disabled via the bus.
- Each output offers the full scope of functions without any restrictions. All channel-oriented functions can be parameterized separately for each output. This feature permits independent and multi-functional control of the outputs.
- Monitoring of the mains voltage of the actuator. In case of mains voltage failure, an alarm message can be transmitted to the bus (polarity can be parameterized).

Blinds operation

- Mode of operation parameterizable: control of blinds with slats, shutters, awnings or venting louvers.
- Separately parameterizable curtain travelling times with travelling time extension for moves into the upper end position.
- For blinds with slats, a slat moving time can be independently parameterized
- Travel direction change-over time and the times for STEP and MOVE operation presettable.
- Central control of all shutter outputs via 1-bit MOVE operation telegram possible.
- Curtain or slat position feedback telegram (only with bus control). In addition, an invalid curtain position or an invalid travel movement can be reported back. Active (transmitting after changes or cyclically to the bus) or passive (object readout) feedback functions.
- Assigning of outputs to up to 5 different safety functions (3 wind alarms, 1 rain alarm, 1 frost alarm) optionally with cyclical monitoring. The safety functions (objects, cycle times, priority) are programmed device-oriented and in common for all outputs. The assignment of individual outputs to the safety functions and the safety measures can be parameterized for each channel.
- An extensive sun protection function with fixed and variable curtain or slat positions at the beginning and at the end of the function can be activated separately for each output. Dynamic slat offset for slatted blinds included. Also with enlarged sun protection feature for integration into sophisticated shading control programs (operated via separate automatic and disabling object). Optionally also with automatic heating/cooling and presence detection function.
- Forced position function can be implemented for each blind output.
- Up to 8 internal scenes parameterizable per output.

Switching operation

- Independent switching of the switching outputs.
- Operation as NO or NC contacts.
- Central switching function with centralized feedback.
- Switching feedback mode (only with bus operation): active (after changes or cyclical transmission to the bus) or passive (object readout function) feedback function.
- Logic function individual for each output.
- Disabling function can be parameterized for each channel. Forced position function separately for each output as an alternative.

- Timing functions (switch-on delay, switch-off delay, staircase lighting timer, also with pre-warning function)
- Incorporation into light moods: up to 8 internal scenes parameterizable per output.
- Operating hours counter can be activated independently for each output.
- Input monitoring for cyclical updating of the switching object with safety position.

Valve outputs

- 2 mutually independent outputs that can be controlled via a switching (1 bit) or alternatively via a constant (1 byte) command value telegram. Constant command values are converted via pulse-width modulation at the output. The cycle time of the output signals is generally parameterizable in this case.
- Status feedback (1 bit or 1 byte) of each output possible automatically or on read request.
- Valve direction of action (open or closed in deenergized state) can be parameterized each output.
- Summer or winter mode can be selected via an object (polarity configurable).
- Cyclical monitoring of the command value of each output can be set, taking into account a generally parameterizable monitoring time. If no telegram is received within the specified monitoring time, the output concerned switches to emergency operation, and an alarm message can be transmitted to the bus (polarity can be parameterized).
- Forced position for activation of a fixed valve position parameterized in the ETS. Various valve positions can be preset for summer and winter mode. In forced operation the electronic switching outputs can no longer be controlled via the bus.
- If the command values of all valves are "OFF" or "0", the centralized message "All valves closed" can be transmitted to the bus via an object. The telegram polarity of this status message can be configured in the ETS.
- The largest active 1-byte valve output command value in the actuator can be transmitted to the bus via a separate object.
- Short-circuit and overload protection. Optionally with a separate alarm message to the bus (polarity can be parameterized).
- Anti-sticking protection for the connected valve drives.

4.2.2 Software information

ETS configuration and commissioning

For configuration and commissioning of this device it is recommended to use ETS3.0d. Advantages with regard to downloading (significantly shorter loading times) and parameter programming can be expected only if this ETS patch version or later versions are used. The advantages consist in using the new mask version 7.5 and the parameter presentation of the ETS3.

The product database necessary for ETS3.0d is provided in *.VD4 format. The corresponding application program has the version number "1.1".

For ETS2 and older versions of ETS3, a separate product database is available in *.VD2 format. The application program for these ETS versions has the version number "0.1".

As far as the scope of functions of the parameters described in this documentation is concerned, there is no difference between the two application programs.

In the case of an update from older ETS versions to ETS3.0d or to newer version, an additional tool is available as an ETS3 add-in. This tool is able to convert older product databases with application version "0.1" – for example from existing ETS2 projects – into the new application format (version "1.1"). This way you can make use of the advantages of the ETS3.0d application easily and without changing the configuration. The ETS3 add-in can be obtained separately and free of charge from the manufacturer.

Safe-state mode

If the device - for instance as a result of errors in the configuration or during commissioning - does not work properly, the execution of the loaded application program can be halted by activating the safe-state mode. The safe-state mode does not permit controlling the outputs via the bus and by hand. The actuator remains passive since the application program is not being executed (state-of-execution: terminated). Only the system software is still functional so that the ETS diagnosis functions and also programming of the device continue to be possible.

Activating the safe-state mode

- Shut off the bus and the mains voltage supply.
- Press the programming button and keep it pressed.
- Switch on the bus or mains voltage. Release the programming button only after the programming LED starts flashing slowly.

The safe-state mode is activated. With a new brief press on the programming button, the programming mode can be switched on and off as usual also in the safe-state mode. The programming LED will nevertheless continue to flash independently of the programming mode as long as the safe-state mode is active.

- i** The safe-state mode can be terminated by switching off the supply voltage (bus and mains) or by programming with the ETS.

Unloading the application program

The application program can be unloaded with the ETS. In this case, manual control as part of the application program is not available either.

4.2.3 Object table

Number of communication objects:	72 (max. object number 87 - gaps in between)
Number of addresses (max):	254
Number of assignments (max):	255
Dynamic table management:	No
Maximum table length:	255

Channel-independent general objects:

Function: Manual control

Object	Function	Name	Type	DP type	Flag
 ⁰	Disabling	Manual control	1 bit	1.003	C, W, -, (R) ₁

Description 1-bit object for disabling the keys for manual control on the device. The polarity can be parameterized.

Function: Manual control

Object	Function	Name	Type	DP type	Flag
 ¹	Status	Manual control	1 bit	1.002	C, -, T (R) ¹

Description 1-bit object for manual control status transmission. The object is "0", when manual control is deactivated (bus control). The object is "1", when manual control is being activated. The user can parameterize whether the temporary or the permanent manual control will be indicated as status information or not.

Channel-independent objects for blinds operation:

Function: Blinds central function (blinds operation)

Object	Function	Name	Type	DP type	Flag
 ²	Central travel control	All blind outputs	1 bit	1.008	C, W, -, (R) ₂

Description 1-bit object for central actuation (MOVE operation) of assigned blind outputs. The polarity can be parameterized.

Function: Safety function (blinds operation)

Object	Function	Name	Type	DP type	Flag
 ³	Wind alarm 1	Blind safety	1 bit	1.005	C, W, -, (R) ₂

Description 1-bit object for central activation or deactivation of the first wind alarm ("0" = wind alarm deactivated / "1" = wind alarm activated).

1: For reading, the R-flag must be set. The last object written to the object via the bus is read out.

2: Each communication object can be read out. For reading, the R-flag must be set.

Function: Safety function (blinds operation)

Object	Function	Name	Type	DP type	Flag
 4	Wind alarm 2	Blind safety	1 bit	1.005	C, W, -, (R) 1

Description 1-bit object for central activation or deactivation of the second wind alarm ("0" = wind alarm deactivated / "1" = wind alarm activated).

Function: Safety function (blinds operation)

Object	Function	Name	Type	DP type	Flag
 5	Wind alarm 3	Blind safety	1 bit	1.005	C, W, -, (R) 1

Description 1-bit object for central activation or deactivation of the third wind alarm ("0" = wind alarm deactivated / "1" = wind alarm activated).

Function: Safety function (blinds operation)

Object	Function	Name	Type	DP type	Flag
 6	Rain alarm	Blind safety	1 bit	1.005	C, W, -, (R) 1

Description 1-bit object for central activation or deactivation of the rain alarm ("0" = rain alarm deactivated / "1" = rain alarm activated).

Function: Safety function (blinds operation)

Object	Function	Name	Type	DP type	Flag
 7	Frost alarm	Blind safety	1 bit	1.005	C, W, -, (R) 1

Description 1-bit object for central activation or deactivation of the frost alarm ("0" = frost alarm deactivated / "1" = frost alarm activated).

Channel-independent objects for switching operation:

Function: Central switching function (switching operation)

Object	Function	Name	Type	DP type	Flag
 8	Central switching	All switching outputs	1 bit	1.001	C, W, -, (R) 1

Description 1-bit object for central switching of switching outputs assigned. The polarity can be parameterized.

Function: Centralized feedback (switching operation)

Object	Function	Name	Type	DP type	Flag
 9	Centralized feedback	All switching outputs	4 byte	27.001	C, -, T, (R) 1

Description 4-byte object for centralized feedback of all switching states of the actuator.

1: Each communication object can be read out. For reading, the R-flag must be set.

Channel-oriented objects for switching operation:

Function: Output switching (switching operation)

Object	Function	Name	Type	DP type	Flag
 10, 23, 36, 49	Switching	Output 1 – 4	1 bit	1.001	C, W, -, (R) 1

Description 1-bit object for activating an output ("1" = switch on / "0" switch off; observe the parameterized mode of operation!)

Function: Forced position (switching operation)

Object	Function	Name	Type	DP type	Flag
 11, 24, 37, 50	Forced position	Output 1 – 4	2 bit	2.001	C, W, -, (R) 1

Description 2-bit object for forced control of an output. The object state after bus voltage return can be predefined by means of a parameter.

Function: Disabling function (switching operation)

Object	Function	Name	Type	DP type	Flag
 12, 25, 38, 51	Disabling	Output 1 – 4	1 bit	1.003	C, W, -, (R) 1

Description 1-bit object for disabling of an output (polarity can be parameterized).

Function: Logic operation function (switching operation)

Object	Function	Name	Type	DP type	Flag
 13, 26, 39, 52	Logic operation	Output 1 – 4	1 bit	1.002	C, W, -, (R) 1

Description 1-bit object for the input of the logic operation of an output. The object value after bus voltage return or after programming with the ETS can be predefined with parameters.

Function: Staircase function (switching operation)

Object	Function	Name	Type	DP type	Flag
 14, 27, 40, 53	Staircase function start/stop	Output 1 – 4	1 bit	1.010	C, W, -, (R) 1

Description 1-bit object for activating or deactivating the switch-on time for the staircase function of an output ("1" = switch on / "0" = switch off).

1: Each communication object can be read out. For reading, the R-flag must be set.

Function: Staircase function (switching operation)

Object	Function	Name	Type	DP type	Flag
 15, 28, 41, 54	Staircase function factor	Output 1 – 4	1 byte	5.010	C, W, -, (R) 1

Description 1-byte object for presetting a time factor for the staircase time of the staircase function (value range: 0 ... 255).

Function: Scene function (switching operation)

Object	Function	Name	Type	DP type	Flag
 16, 29, 42, 55	Scene extension	Output 1 – 4	1 byte	18.001	C, W, -, (R) 1

Description 1-byte object for recalling scenes or for storing new scene values.

Function: Switching status feedback (switching operation)

Object	Function	Name	Type	DP type	Flag
 18, 31, 44, 57	Switching feedback	Output 1 – 4	1 bit	1.001	C, -, T, (R) 1,2

Description 1-bit object for switching status feedback ("1 = switched on / "0" switched off; observe the parameterized mode of operation!)

Function: Operating hours counter (switching operation)

Object	Function	Name	Type	DP type	Flag
 19, 32, 45, 58	Operating hours counter limit value / start value	Output 1 – 4	2 byte	7.007	C, W, -, (R) 1

Description 2-byte object for external presetting of a limit value / start value of the operating hours counter of an output (value range: 0 ... 65535).

Function: Operating hours counter (switching operation)

Object	Function	Name	Type	DP type	Flag
 20, 33, 46, 59	Op. hours counter restart	Output 1 – 4	1 bit	1.015	C, W, -, (R) 1

Description 1-bit object for resetting the operating hours counter of an output ("1" = reset, "0" = no reaction).

1: Each communication object can be read out. For reading, the R-flag must be set.

2: The communication flags are set automatically depending on the parameterization. "T"-flag for an active signalling object; "R"-flag for a passive status object.

Function: Operating hours counter (switching operation)

Object	Function	Name	Type	DP type	Flag
 21, 34, 47, 60	Op. hours counter value	Output 1 – 4	2 byte	7.007	C, -, T, (R) 1

Description 2-byte object for transmitting or reading out the current count of the operating hours counter. The value of the communication object is not lost in the event of bus voltage failure, and is transmitted actively to the bus after bus voltage return or after ETS programming. In the state as supplied this value is "0".

Function: Operating hours counter (switching operation)

Object	Function	Name	Type	DP type	Flag
 22, 35, 48, 61	Operating hours counter elapsed	Output 1 – 4	1 bit	1.002	C, -, T, (R) 1

Description 1-bit object for reporting that the operating hours counter has elapsed (up-counter = limit value reached / down-counter = value "0" reached). For a message the object value is transmitted actively to the bus ("1" = message active / "0" = message inactive). The value of the communication object is not lost in the event of bus voltage failure, and is transmitted actively to the bus after bus voltage return or after ETS programming, if the message is active. Otherwise only the object is initialised.

Channel-oriented objects for blinds operation:

Function: MOVE operation (blinds operation)

Object	Function	Name	Type	DP type	Flag
 10, 36	MOVE operation	Output 1/2 – 3/4	1 bit	1.008	C, W, -, (R) 1

Description 1-bit object for activation of the MOVE operation

Function: STEP operation (blinds operation)

Object	Function	Name	Type	DP type	Flag
 11, 37	STEP operation	Output 1/2 – 3/4	1 bit	1.007	C, W, -, (R) 1

Description 1-bit object for activation of the STEP operation or for stopping of a travel movement.

Function: Forced position (blinds operation)

Object	Function	Name	Type	DP type	Flag
 12, 38	Forced position	Output 1/2 – 3/4	2 bit	2.008	C, W, -, (R) 1

Description 2-bit object for forced control of an output. The object state after bus voltage return can be predefined by means of a parameter.

1: Each communication object can be read out. For reading, the R-flag must be set.

Function: Scene function (blinds operation)

Object	Function	Name	Type	DP type	Flag
 13, 39	Scene extension	Output 1/2 – 3/4	1 byte	18.001	C, W, -, (R) 1

Description 1-byte object for recalling scenes or for storing new scene values.

Function: Sun protection function (blinds operation)

Object	Function	Name	Type	DP type	Flag
 15, 41	Automatic mode	Output 1/2 – 3/4	1 bit	1.003	C, W, -, (R) 1

Description 1-bit object for activation or deactivation of the automatic sun protection in the enlarged sun protection mode ("1" = automatic mode activated / "0" = automatic mode deactivated). The object is only visible if the automatic sun protection is to be tracked immediately when the state of the automatic object changes (parameter setting).

Function: Sun protection function (blinds operation)

Object	Function	Name	Type	DP type	Flag
 16, 42	Automatic mode disable	Output 1/2 – 3/4	1 bit	1.003	C, W, -, (R) 1

Description 1-bit object for disabling of the automatic sun protection in the enlarged sun protection mode. The polarity can be parameterized. The object is only visible if the automatic sun protection is to be tracked immediately when the state of the automatic object changes (parameter setting).

Function: Sun protection function (blinds operation)

Object	Function	Name	Type	DP type	Flag
 16, 42	Automatic mode	Output 1/2 – 3/4	1 bit	1.003	C, W, -, (R) 1

Description 1-bit object for activation or deactivation of the automatic sun protection in the enlarged sun protection mode. The polarity can be parameterized. The object is only visible if the automatic sun protection is to be tracked only when the state of the automatic object changes next time (parameter setting).

Function: Sun protection function (blinds operation)

Object	Function	Name	Type	DP type	Flag
 17, 43	Disabling direct operation	Output 1/2 – 3/4	1 bit	1.003	C, W, -, (R) 1

Description 1-bit object for disabling direct operation in the enlarged sun protection mode (direct operation = Move / Step / Position / Scene / Central). The polarity can be parameterized.

1: Each communication object can be read out. For reading, the R-flag must be set.

Function: Sun protection function (blinds operation)

Object	Function	Name	Type	DP type	Flag
 18, 44	Sunshine / shading facade	Output 1/2 – 3/4	1 bit	1.002	C, W, -, (R) ₁

Description 1-bit object for activation or deactivation of sun shading in the simple or enlarged sun protection mode (sun is shining / sun is not shining). The polarity can be parameterized.

Function: Sun protection function (blinds operation)

Object	Function	Name	Type	DP type	Flag
 19, 45	Sunsh./shading position ²	Output 1/2 – 3/4	1 byte	5.001	C, W, -, (R) ₁

Description 1-byte object for presetting a variable position value (0...255) for the height of the blind/shutter curtain or the venting louver position when the sun protection is active.

Function: Sun protection function (blinds operation)

Object	Function	Name	Type	DP type	Flag
 20, 46	Sunsh./shading slat position	Output 1/2 – 3/4	1 byte	5.001	C, W, -, (R) ₁

Description 1-byte object for presetting a variable slat position value (0...255) when the sun protection is active.

Function: Sun protection function (blinds operation)

Object	Function	Name	Type	DP type	Flag
 21, 47	Sunshine slat position offset	Output 1/2 – 3/4	1 byte	6.001	C, W, -, (R) ₁

Description 1-byte object for presetting a slat position angle (- 100 % ... +100 % / smaller or larger position angles are treated as + or – 100 %) for 'manual' readjustment of the slat position during active sun protection.

Function: Sun protection function – automatic heating/cooling (blinds operation)

Object	Function	Name	Type	DP type	Flag
 22, 48	Heating/cooling presence	Output 1/2 – 3/4	1 bit	1.018	C, W, -, (R) ₁

Description 1-bit object for activation of the presence mode during automatic heating/cooling. The polarity can be parameterized. This object is generally linked with presence detectors.

- 1: Each communication object can be read out. For reading, the R-flag must be set.
- 2: The object designation varies with the type of curtain (blind, shutter / awning, venting louver).

Function: Sun protection function – automatic heating/cooling (blinds operation)

Object	Function	Name	Type	DP type	Flag
 23, 49	Heating/cooling change-over:	Output 1/2 – 3/4	1 bit	1.100	C, W, -, (R) ₁

Description 1-bit object for changing over between heating and cooling operation during automatic heating/cooling. The polarity can be parameterized. This object is generally linked with room thermostats (object "heating/cooling change-over").

Function: Position feedback (blinds operation)

Object	Function	Name	Type	DP type	Flag
 24, 50	Position feedback ²	Output 1/2 – 3/4	1 byte	5.001	C, -, T, R ^{1,3}

Description 1-byte object for position feedback of the blind/shutter curtain height or louver position (0...255).

Function: Position feedback (blinds operation)

Object	Function	Name	Type	DP type	Flag
 25, 51	Slat position feedback	Output 1/2 – 3/4	1 byte	5.001	C, -, T, R ^{1,3}

Description 1-byte object for position feedback of the slat position (0...255) if one shutter is controlled.

Function: Position feedback (blinds operation)

Object	Function	Name	Type	DP type	Flag
 26, 52	Invalid position feedback	Output 1/2 – 3/4	1 bit	1.002	C, -, T, R _{1,3}

Description 1-bit object for reporting back an invalid position of the blind/shutter curtain height or louver position ("0" = position valid / "1" = position invalid).

Function: Travel movement feedback (blinds operation)

Object	Function	Name	Type	DP type	Flag
 27, 53	Travel movement feedback	Output 1/2 – 3/4	1 bit	1.002	C, -, T, R ^{1,3}

Description 1-bit object for active travel movement feedback (output active - up or down). ("0" = no travel movement / "1" = travel movement).

- 1: Each communication object can be read out. For reading, the R-flag must be set.
- 2: The object designation varies with the type of curtain (blind, shutter / awning, venting louver).
- 3: The communication flags are set automatically depending on the parameterization. "T"-flag for an active signalling object; "R"-flag for a passive status object.

Function: Presetting the position (blinds operation)

Object	Function	Name	Type	DP type	Flag
 28, 54	Position 1	Output 1/2 – 3/4	1 byte	5.001	C, W, -, (R) 2

Description 1-byte object for presetting a position value (0...255) for the height of the blind/shutter curtain or the venting louver position in direct operation.

Function: Presetting the position (blinds operation)

Object	Function	Name	Type	DP type	Flag
 29, 55	Slat position	Output 1/2 – 3/4	1 byte	5.001	C, W, -, (R) 2

Description 1-byte object for presetting a slat position value (0...255) in direct operation.

Channel-oriented objects for the valve outputs:

Function: Command value (valve operation)

Object	Function	Name	Type	DP type	Flag
 62, 75	Command value	Output 5 - 6	1 bit	1.001	C, W, -, (R) 2

Description 1-bit object for presetting a switching command value of a room thermostat.

Function: Command value (valve operation)

Object	Function	Name	Type	DP type	Flag
 62, 75	Command value	Output 5 - 6	1 byte	5.001	C, W, -, (R) 2

Description 1-byte object for presetting a constant command value of a room thermostat.

Function: Command value status (valve operation)

Object	Function	Name	Type	DP type	Flag
 63, 76	Command value status	Output 5 - 6	1 bit	1.001	C, -, T, (R) 2

Description 1-bit object for transmitting or reading out status telegrams for the current nominal valve position value for switching command values.
"Valve open" = "1" / "Valve closed" = "0".

Function: Command value status (valve operation)

Object	Function	Name	Type	DP type	Flag
 63, 76	Command value status	Output 5 - 6	1 byte	5.001	C, -, T, (R) 2

Description 1-byte object for transmitting or reading out status telegrams for the current nominal valve position value for constant command values (0...255).

1: The object designation varies with the type of curtain (blind, shutter / awning, venting louver).

2: Each communication object can be read out. For reading, the R-flag must be set.

Function: Forced position (valve operation)

Object	Function	Name	Type	DP type	Flag
 ^{64,} ₇₇	Forced position	Output 5 - 6	1 bit	1.001	C, W, -, (R) ₁

Description 1-bit object for forced control of a valve output ("1" = forced position active / "0" = forced position inactive).

Function: Short-circuit / overload (valve operation)

Object	Function	Name	Type	DP type	Flag
 ^{65,} ₇₈	Short-circuit / overload alarm	Output 5 - 6	1 bit	1.005	C, -, T, (R) ₁

Description 1-bit object for overload or short-circuit message of a valve output to the bus. The object remains active (polarity can be parameterized) until the overload or short-circuit has been eliminated.

Function: Command value monitoring (valve operation)

Object	Function	Name	Type	DP type	Flag
 ^{66,} ₇₉	Command value monitoring alarm	Output 5 - 6	1 bit	1.005	C, -, T, (R) ₁

Description 1-bit object for reported that command values have not been received within the monitoring time for the output in question, and emergency operation has been activated (polarity can be parameterized).

Channel-oriented objects for the valve outputs and for general operation:

Function: Mains failure alarm

Object	Function	Name	Type	DP type	Flag
 ⁸⁴	Mains failure alarm	Actuator power supply	1 bit	1.005	C, -, T, (R) ₁

Description 1-bit object for reporting to the bus a failure of the mains voltage at the supply input of the actuator (polarity can be parameterized).

Function: Valve check (valve operation)

Object	Function	Name	Type	DP type	Flag
 ⁸⁵	All valves closed	Output 5 / 6	1 bit	1.002	C, -, T, (R) ₁

Description 1-bit object for indicating that all command values are "OFF" (1 bit) or "0" (1 byte) and thus all valves are closed (polarity can be parameterized).

1: Each communication object can be read out. For reading, the R-flag must be set.

Function: Summer/winter mode change-over (valve operation)

Object	Function	Name	Type	DP type	Flag
 ⁸⁶	Summer/winter change-over	Output 5 / 6	1 bit	1.001	C, W, -, (R) 1

Description 1-bit object for change-over between summer and winter mode (polarity and preferred value after ETS programming can be parameterized).

Function: Valve check (valve operation)

Object	Function	Name	Type	DP type	Flag
 ⁸⁷	Largest command value feedback	Output 5 / 6	1 byte	5.001	C, -, T, (R) 1

Description 1-byte object for feedback of the largest active 1-byte command value in the actuator.

1: Each communication object can be read out. For reading, the R-flag must be set.

4.2.4 Functional description

4.2.4.1 Description of channel-independent functions

4.2.4.1.1 General channel-independent functions

Delay after bus voltage return

To reduce telegram traffic on the bus line after bus voltage activation (bus reset), after connection of the device to the bus line or after programming with the ETS, it is possible to delay all actively transmitted alarm, status or feedback messages of the actuator. For this purpose, a channel-independent delay can be specified (parameter "Delay after bus voltage return" on parameter page "General"). Feedback telegrams for bus initialisation will therefore be transmitted to the bus only after the parameterized time has elapsed.

Which of the telegrams is actually delayed and which is not can be specified for each output channel and for each message or status function separately.

- i The delay has no effect on the behaviour of the outputs. Only the bus telegrams of the alarm, status or feedback messages are delayed. The outputs can also be activated during the delay after bus voltage return.
- i A setting of "0" for the delay after bus voltage return deactivates the delaying function altogether. In this case, all messages, if actively transmitted, will be transmitted to the bus without any delay.
- i When the mains voltage is switched on (the bus voltage is already switched on), feedback telegrams are always transmitted without any delay.

Mains voltage monitoring

The room actuator has its own mains voltage connection (marking L, N) that is independent of the connected drives or loads. So that the relay outputs and also the electronic switching outputs can be controlled via the device electronics, this mains voltage must always be connected and switched on.

If the mains voltage of the actuator is not switched on, the switching states of the relay outputs and also of the electronic valve outputs can no longer be changed. In this case the electronic switching outputs are also not energized, which means that the connected valve drives can no longer be controlled properly.

The relays (outputs A1...A4) are designed as a bistable contact type so that the switching state last set remains unchanged even in the event of a mains voltage failure until the mains voltage is switched on and the switching state is changed.

So that a mains voltage failure on the actuator does not go undetected in the event of a fault, a mains failure message can be transmitted to the bus via the object "Mains failure alarm" (see picture 8).

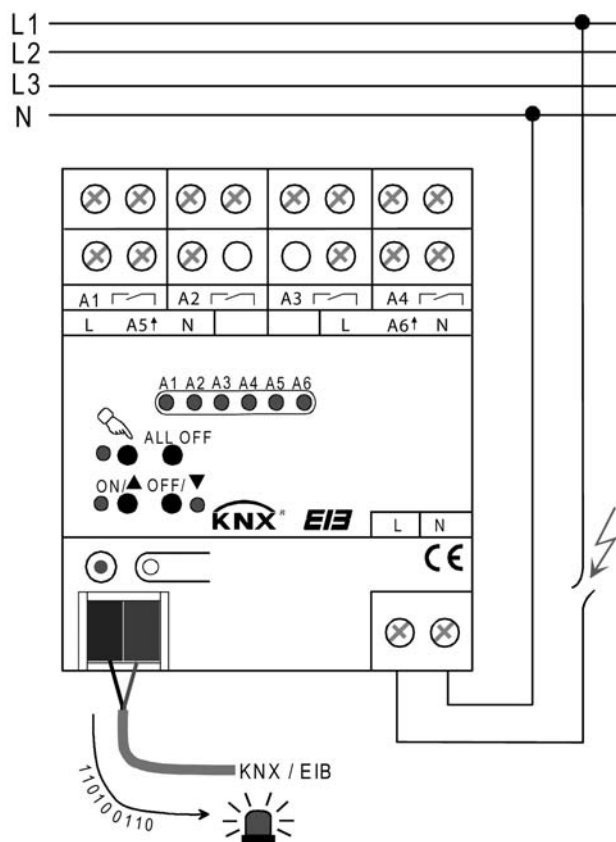

picture 8: Monitoring of the mains voltage

- i** The room actuator monitors exclusively the mains voltage on the connecting terminals for the device voltage supply (terminals L, N). The mains voltage connections of the electronic valve outputs (terminals L A5, L A6) are not monitored for mains failure!

Enabling the alarm message for mains voltage failure

The monitoring of the mains voltage can be enabled globally for the device on the parameter page "General".

- Set the parameter "Alarm object for mains failure" to "enabled". For the parameter "Polarity of 'Mains failure alarm' object", configure the necessary telegram polarity of the alarm telegram.

The mains voltage monitoring is now enabled. The communication object "Mains failure alarm" becomes visible in the ETS object view. As soon as the actuator detects a failure of the mains voltage, it transmits the alarm telegram to the bus in accordance with the configured polarity, if bus voltage is present. Only after the mains voltage has been switched on again does the actuator cancel the previously transmitted alarm message by transmitting to the bus a telegram with the opposite polarity setting.

- i** After bus voltage return or after ETS programming, the current mains voltage status (mains voltage present / not present) is always transmitted actively to the bus. In both cases, however, this transmission only takes place after the end of the "Delay after bus voltage return" configured in the ETS.

- i** In the event of a failure of the mains voltage on the actuator, the connected valve drives are no longer controlled electrically, so that the drives enter the deenergized state preset by the manufacturer (open or closed in deenergized state).
A valve which is completely open due to a mains voltage failure (valve direction of action open in deenergized state) is evaluated like a closed valve for the "Largest command value feedback" and for the statuses "Command value" and "All valves closed", because the valve state was caused by a fault.

Setting the channel definition

Relay outputs A1...A4 of the room actuator can be set in the ETS software configuration either to blinds operation or alternatively to switching operation; mixed operation of these channel definitions for the various outputs of the device is possible (for example A1/A2 blind, A3 switching, A4 switching).

In blinds operation the relay contacts of the room actuator can be used to control electrically driven blinds, shutters, awnings, venting louvers or similar curtains for 230 V AC mains voltage. Alternatively, the actuator can switch electrical loads, such as lighting systems in switching operation.

The channel definition can be configured separately for each output pair on the parameter page "Channel definition". All channel-dependent parameters and objects are created and displayed in the ETS depending on this setting.

Depending on the selected channel definition, the outputs can either be configured separately (switching operation e.g. A1, A2, A3, A4), or can be combined into output pairs (blinds operation e.g. A1/2, A3/4). The names of the output objects and the parameter page change accordingly. The outputs are combined as described also in the manual control mode.

In blinds operation each output of the output pair controls one of the travel directions (e.g. A1 – up / A2 – down). The travel directions are mutually interlocked via the actuator's application software, thus ensuring that simultaneous activation of both travel directions impossible when the room actuator is operating with no errors.

Configuring the channel definition



CAUTION!

Operating the actuator outside of its technical specifications (see "Technical data") can cause relay contacts to weld together.

Danger of destruction of the connected drives if relay contacts weld together, as a result of which both travel directions are energized at the same time.

Operate the actuator exclusively within its technical specifications!

No mechanical interlock of the travel directions has been implemented, because it also has to be possible to activate the outputs separately in switching operation.

- Set the parameter "Output x and output y" (x = 1, 3 / y = 2, 4) to "1 x blind output".
The corresponding output pair is now configured to blinds operation. Both outputs are combined into a single blind channel.
- Set the parameter "Output x and output y" (x = 1, 3 / y = 2, 4) to "2 x blind output".
The corresponding output pair is now configured to switching operation. Both outputs are defined separately from each other as two switching channels.

- i** The parameter and object configurations of the individual outputs are dependent on the parameters on the page "Channel definition", and are changed by the ETS when the channel definition is reconfigured. This means that parameter settings or assignments of group addresses to objects can be lost. For this reason, set the channel definitions at the beginning of parameterization of the actuator.

- i** The function of outputs A5 and A6 is configured as a valve output, and cannot be changed. These outputs are functionally independent of outputs A1...A4.

Manual control

All outputs of the room actuator can also be operated manually. The button field with 4 function keys and 3 status LEDs on the front panel of the device can be used for setting and controlling the following modes of operation...

- Bus control: operation from touch sensors or other bus devices
- Temporary manual control: manual control via the button field, automatic return to bus operation,
- Permanent manual control: exclusively manual control of the device via the button field, return to bus operation only after manual control is aborted manually.

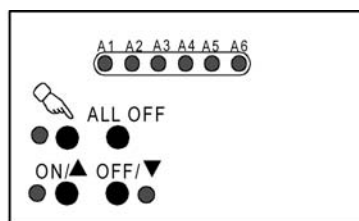

picture 9: Elements for manual control on the front panel of the device

The operation of the function keys, the control of the outputs and the status display are described in detail in chapter "2.5 Manual control".

The parameterization, status feedback, disabling via bus operation, and interaction with other functions of the actuator when manual control is activated and deactivated are described in greater detail in the following paragraphs.

Manual control is possible only while the actuator is supplied with power from the mains. In the state as supplied the manual control mode is fully enabled. In this unprogrammed state, the individual outputs can be switched on and off even without bus voltage so that fast function checking of the connected drives (e.g. at the building site) is possible.

After the first commissioning of the actuator with the ETS, the manual control mode can be separately enabled or disabled for different states of operation. Manual control can, for instance, be disabled during bus operation (bus voltage applied). Another option consists in the complete disabling of the manual control only in case of bus voltage failure. Manual control can therefore be completely disabled during bus operation, but also in case of bus failures only.

Enabling the manual control mode

Manual control for the different states of operation is enabled by means of the parameters "Manual control in case of bus voltage failure" and "Manual control during bus operation".

- Set the parameter "Manual control in case of bus voltage failure" to "enabled".
Manual control is then basically enabled when the bus voltage is off. This setting corresponds to the setting of the actuator as supplied.
- Set the parameter "Manual control in case of bus voltage failure" to "disabled".
Manual control is completely disabled when the bus voltage is off. In this case, bus operation is not possible either so that the outputs of the actuator can no longer be actuated.
- Set the parameter "Manual control during bus operation" to "enabled".

Manual control is then basically enabled when the bus voltage is on. The outputs of the actuator can be operated via the bus or manually. This setting corresponds to the setting of the actuator as supplied.

- Set the parameter "Manual control during bus operation" to "disabled".

Manual control is completely disabled when the bus voltage is on. In this configuration, the actuator outputs can only be operated via the bus.

- i** Further parameters and communication objects of the manual control are visible only in the configuration "Manual control during bus operation = enabled". For this reason, the disabling function, the status message and bus control disabling can only be configured in the above parameter setting.

Presetting the behaviour at the beginning and at the end of manual control.

Manual control is divided into temporary and permanent manual control. Depending on these modes, the actuator behaves differently, especially at the end of manual control. It should always be noted that bus operation is always disabled while manual control is active. This means that the manual control mode has the highest priority.

Behaviour at the beginning of manual control:

The behaviour at the beginning of manual control does not differ for temporary and permanent manual control. When manual control is activated, all travel movements for blind outputs that were started beforehand by bus control will still be completed unless the travel movement in question is stopped by hand. Furthermore, switching states of switching outputs (A1...A4) will be maintained. The switching state or a PWM to the electronic valve outputs, i.e. the active command value, will also initially remain unaffected by the activation of manual control, and its execution continues without interruption.

Active forced positions, disabling, safety and sun protection functions can be overridden by manual control. These functions are reactivated after deactivation of manual control unless they have been cancelled in the meantime via the bus. Then the function with the higher priority is always executed.

Behaviour at the end of manual control:

The behaviour at the end of manual control is different for temporary and permanent manual control.

Temporary manual control is switched off automatically as soon as the last output has been selected and the selection button  is pressed another time, or no button is pressed for 5 s. When temporary manual control is switched off the actuator returns to "normal" bus operation and does not change the status last set via manual control. If, however, a forced position, a disabling function, a safety function or a sun protection function (independent of priority) has been activated via the bus before or during manual control, the actuator executes these functions with a higher priority again for the outputs concerned.

Permanent manual control is switched off if selection button  is pressed for longer than 5 s. Depending on the parameterization of the actuator in the ETS, the outputs will be set to the state last adjusted in the manual mode or to the state internally tracked (direct operation, forced position, disabling, safety or sun protection position) when the permanent manual mode is switched off. The parameter "Behaviour at the end of permanent manual control during bus operation" defines the corresponding reaction.

- Set the parameter "Behaviour at the end of permanent manual control during bus operation" to "no change".

All telegrams received during an active permanent manual control mode for direct operation (switching, MOVE/STEP, positioning, central, scenes, command value telegrams) will be rejected. After the end of the permanent manual control mode, the state of all outputs that were last current in manual control remains unchanged.

If, however, a forced position, a disabling function, a safety function or a sun protection function (independent of priority) has been activated via the bus before or during manual control, the actuator executes these functions with a higher priority for the outputs concerned.

- Set the parameter "Behaviour at the end of permanent manual control during bus operation" to "output tracking".

During an active permanent manual control all incoming telegrams (blinds operation: short-time telegrams – step/stop excepted) are internally tracked. At the end of the manual control mode, the outputs will be set to the tracked states or to the position last set before the permanent manual control mode for blind outputs. The individual priorities of the functions with respect to one another are taken into account here; in each case only the function with the higher priority is executed. A MOVE operation is not tracked if the corresponding blind output is already in the corresponding end position.

- i** The behaviour at the end of the permanent manual control when the bus voltage is off (only manual control) is permanently set to "no change".
- i** The control operations triggered during manual control update the states of the feedback and status objects. Telegrams are also transmitted to the bus if the signalling objects concerned are enabled in the ETS and are parameterized as actively transmitting.
- i** The following must be observed for the electronic valve outputs:
In temporary or permanent manual control the connected valve drives, regardless of the data format of the command value, are controlled with a PWM if the valves are opened by manual control. The pulse/pause ratio of this PWM and its cycle time are configured in the ETS.
At the end of temporary manual control or permanent manual control with the setting "Behaviour at the end of permanent manual control during bus operation = no change", any valve last opened by the manual control will be controlled further via PWM without interruption until a new command value is received via the command value objects. This is also always done for valve outputs that are configured in the ETS as switching (command value 1 bit). The PWM of a terminated manual control cannot, however be overridden by a forced position, if a forced position is active.
- i** Manual control is possible only while the actuator is supplied with power from the mains. The bus supply voltage does not have to be connected or switched on (building site operation).
In the event of a bus voltage failure, manual control is automatically terminated and all relays and also the electronic valve outputs are switched off. The parameterized "Behaviour at the end of permanent manual control" is not carried out here.
In case of bus voltage return, active manual control is automatically terminated and the actuator executes the "Behaviour after bus or mains voltage return".
Failure of the bus voltage when the mains voltage supply is switched on does not end manual control. In this case the actuator does not execute the "behaviour in case of bus voltage failure" configured in the ETS.
At the beginning of any ETS programming process, manual control is terminated automatically. Manual control cannot be activated or continued during an ETS programming process.

Presetting a manual control disable

The manual control mode can be separately disabled via the bus, even if it is already active. As soon as a disabling telegram is received via the disabling object in case the disabling function is enabled, the actuator ends an activated manual control mode immediately and interlocks the function keys on the device panel. The telegram polarity of the disabling object is parameterizable.

The manual control mode during bus operation must be enabled in the ETS.

- Set the parameter "Disabling function ?" on parameter page "Manual control" to "yes".

The disabling function of the manual control mode is enabled and the disabling object is visible.

- Select the desired telegram polarity in the "Disabling object polarity" parameter.
- i** If the polarity is "0 = disabled; 1 = enabled", the disabling function is immediately active on return of bus voltage or after an ETS programming operation (object value "0"). To activate the manual control in this case, an enable telegram "1" must first be sent to the disabling object.
- i** In case of bus voltage failure the disabling via the disabling object is always inactive (manual control is then either enabled or completely disabled in accordance with the parameter "Manual control in case of bus voltage failure". After return of bus voltage a disabled state that was active before will be reactivated.
- i** In the event of failure of the supply voltage (bus voltage and mains voltage failure) the disable is deactivated via the disabling object. Merely the interruption of the mains voltage supply does not affect the disabling of manual control.
- i** When an active manual control is terminated by a disable, the actuator will also transmit a "Manual control inactive" status message to the bus, if the status messaging function is enabled.

Presetting the status message function for the manual control mode

The actuator can transmit a status message to the bus via a separate object, when the manual control mode is activated or deactivated. The status telegram can only be transmitted when the bus voltage is present. The polarity of the status telegram can be parameterized.

The manual control mode during bus operation must be enabled.

- Set the parameter "Transmit status ?" on the "Manual control" parameter page to "yes".
The status messaging function of manual control is enabled and the status object is visible.
- Specify in the parameter "Status object function and polarity" whether the status telegram is generally a "1" telegram whenever the manual control mode is activated or only in those cases where the permanent manual mode is activated.
- i** The status object is always "0", when the manual control mode is deactivated.
- i** The status will be actively transmitted to the bus ("OFF") only if a manual control that was previously activated is terminated by the return of the bus voltage. The status telegram is in this case transmitted without delay.
Manual control is terminated by a mains voltage failure or ETS programming. In case of a bus voltage failure a status telegram "OFF" is transmitted, if the bus voltage is switched on at that instant. The current status is also not transmitted automatically after ETS programming. After bus voltage return or after programming with the ETS, the value of the status object is " 0 " and can also be read out.
- i** When an active manual control is terminated by a disabling function of the manual control mode, the actuator will also transmit a "Manual control inactive" status message to the bus.

Setting disabling of the bus control

Individual switching, valve or blind outputs can be disabled locally by means of manual control on the device, so that the outputs concerned can no longer be activated by means of bus telegrams. Such disabling of the bus operation is initiated by operation in permanent manual control and is indicated by rapid flashing of the status LEDs (A1...A6) of the outputs concerned. The disabled outputs can then only be activated in permanent manual control.

The manual control mode during bus operation must be enabled in the ETS.

- Set the parameter "Bus control of individual outputs can be disabled during bus operation" on parameter page "Manual control" to "Yes".
The function for disabling the bus control is enabled and can be activated locally. As an alternative, this parameter can be set to "no" to prevent activation of disabling of the bus control in permanent manual control.

- i** The disabling initiated locally has the highest priority. Thus all other functions of the actuator that can be activated via the bus (e.g. forced position, disabling or safety function, and the like), are overridden. The bus-disabled output remains in the state last set in permanent manual control.
Depending on the parameterization of the actuator in the ETS, the outputs will be set to the state last adjusted in the manual mode or to the state internally tracked (direct operation, forced position, disabling, safety or sun protection position) when the disabling function is terminated and permanent manual control is subsequently shut off.
- i** Any disabling of the bus control activated locally is not reset in case of bus voltage failure or return. Even a mains voltage failure does not by itself reset the disabling. A failure of the supply voltage (bus and mains voltage failure) does deactivate the disabling of the bus control.

Setting pulse-width modulation for valve outputs in manual control

If valve outputs are to be opened during temporary or permanent manual control, the carries out pulse-width modulation (PWM) on the valve outputs concerned. This is also always done for valve outputs that are configured in the ETS as switching (command value 1 bit). The pulse/pause ratio of the PWM is configured specially for manual control in common for outputs A5 & A6 in the ETS on the parameter page "Manual control". The cycle time of this PWM is defined independent of the channel on the parameter page "Valve output times".

The manual control mode during bus operation must be enabled in the ETS.

- Configure the parameter "Only for valve outputs: PWM in manual control (1...100%)" to the necessary valve position value.

When a valve is opened via manual control, the specified pulse-width modulation is executed for constant and also for switching (!) valve outputs, and thus the valve will be open constantly.

- i** A special feature is that for manual control the PWM can be configured to 100 %. In this case the command "open valve" opens the valve permanently without carrying out pulse-width modulation. Consequently a button command "close valve" closes the valve output permanently. In this case, too the activation of the outputs is performed taking into account the configured valve direction of action.
- i** In the state as supplied the PWM in manual control is preset to 50 % PWM with 15 minutes cycle time.

4.2.4.1.2 Channel-independent functions for relay switching outputs

Central function for switching outputs

The actuator offers the possibility of linking selected individual or all switching output channels with a 1-bit central communication object. The behaviour in case of activating an output via the central function is comparable to a central group address linked with all "Switching" objects.

The outputs assigned to the central function are activated in accordance with the central object value received. The polarity of the central telegram can, if necessary, be inverted by means of a parameter.

The behaviour of the channels is identical to the 'normal' activation via the objects "Switching" (same priority – last switching command is carried out). Thus the 'downstream' functions such as time or supplementary functions or logic operations are also taken into account (see picture 10). The parameterized relay operation is also evaluated separately for each output.

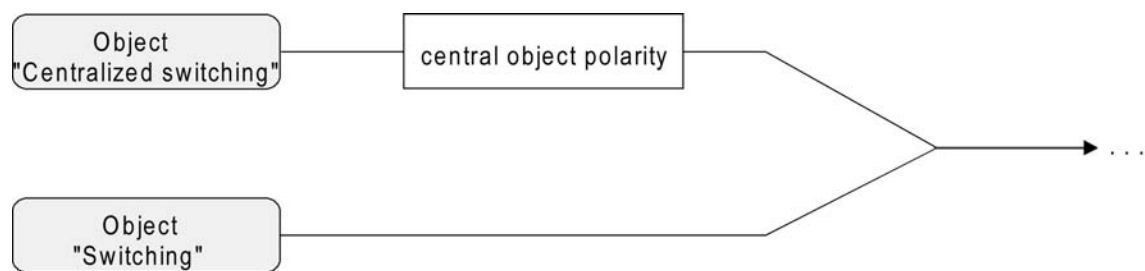

picture 10: Functional diagram "Centralized switching"

Enabling the central function

- Enable the central function on parameter page "General switching outputs" by setting the "Central function for switching outputs ?" parameter to "Yes".
When the function is activated, the "Centralized switching" communication object is visible.

Assigning switching outputs of the central function

Each switching output can be assigned independently to the central function.

The central function must have been enabled on parameter page "General switching outputs". The assignment has otherwise no effect on the switching output.

- Set the "Assignment to central function" parameter on parameter page "Ax-General" (x = 1, 2, 3, 4) to "Yes".
The corresponding output is now assigned to the central function. It can be switched on or off centrally.
- i** The switching state set by the central function is tracked in the feedback objects and also transmitted to the bus, if they are actively transmitting. The switching state set by a central function is not tracked in the "Switching" objects.
- i** After a bus voltage return or after programming with the ETS, the central function is always inactive (object value "0").

Centralized feedback for switching outputs

After central commands or after bus voltage return, a bus line is generally heavily loaded by data traffic as many bus devices are transmitting the state of their communication objects by means of feedback telegrams. This effect is particularly remarkable when visualizations are used. To keep the telegram load low during a 'bus initialisation', the centralized feedback function of the actuator can be employed.

The centralized feedback summarizes the switching states of all switching outputs in a single telegram. The 32-bit communication object "Centralized feedback" contains bit-oriented feedback information for the individual outputs (see picture 11).

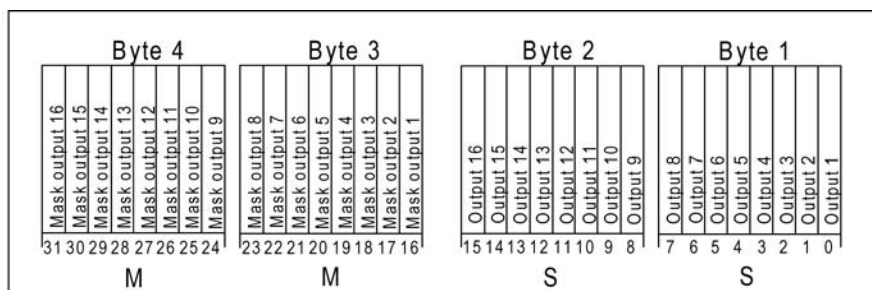

picture 11: Structure of the centralized feedback object

It is possible to depict logically up to 16 outputs and thus up to 16 different switching states. Each of these outputs has one bit that indicates the switching state ("S" bit), and another bit that defines the masking ("M"-Bit). The "S" bits correspond to the logically non-inverted switching states of the outputs, and are either "1" (switched on) or "0" (switched off). The "M" bits are "1" if the actuator has this output. Similarly, the "M" bits are "0" if the corresponding output is not present in the actuator or if the channel is configured as a blind output. In these last two cases the associated "S" bits are permanently "0", because no switching state exists.

This produces the following object value formats for the room actuator...

Outputs A1...A4 configured to switching operation: "00 0F 00 0x", x = switching states

Outputs A1...A2 configured to switching operation: "00 03 00 0x", x = switching states (bits 0 & 1)

Outputs A3...A4 configured to switching operation: "00 0C 00 0x", x = switching states (bits 2 & 3)

The datapoint type of the centralized feedback corresponds to the KNX standard (DPT 27.001). It could be used in suitable visualisation applications - for example in public buildings like schools or hospitals - where the switching states of all of the actuating systems are displayed centrally, and there is no separate display of switching states at the control sections. In such applications the centralized feedback can replace the 1-bit individual feedback telegrams, thus significantly reducing the load on the bus.

Activating the centralized feedback function

The centralized feedback can be used as an active signalling object or as a passive status object. As an active signalling object, the centralized feedback information is transmitted to the bus whenever a switching state changes. As a passive status object, there is no telegram transmission after a change. In this case, the object value must be read out. The ETS automatically sets the object communication flags required for proper functioning.

- Set the parameter "Use centralized feedback for switching outputs ?" on the parameter page "General switching outputs" of the corresponding function to "Yes, active signalling object" or "Yes, passive status object".

The 4-byte communication object "Centralized feedback" is enabled. The object can be used as soon as a group address is associated.

Setting centralized feedback in case of bus voltage return or ETS programming

The state of the centralized feedback is transmitted to the bus after bus voltage return or after ETS programming when used as an active signalling object. In these cases the feedback telegram can be transmitted with a time, with the delay being preset globally for all outputs in common (see "Delay after bus voltage return").

- Set the parameter "Time delay for feedback telegram after bus voltage return" of the centralized feedback to "Yes".
The centralized feedback is transmitted with a delay after bus voltage return or ETS programming. No feedback telegram is transmitted during a running delay, even if a switching state changes during this delay.
 - Set the parameter "Time delay for feedback telegram after bus voltage return" of the centralized feedback to "No".
The centralized feedback telegram is transmitted immediately after bus voltage return or ETS programming.
- i** When only the mains voltage is switched on (the bus voltage is already switched on), no centralized feedback telegrams are transmitted to the bus automatically.

Activating cyclical transmission for centralized feedback telegrams

By means of the actively transmitting signalling object, the centralized feedback telegram can – besides being sent in case of state changes – also be transmitted cyclically.

- Set the parameter "Cyclic transmission of the centralized feedback ?" on the "General switching outputs" parameter page to "Yes".
Cyclical transmission is now activated.
 - Set the parameter "Cyclic transmission of the centralized feedback ?" on the "General switching outputs" parameter page to "No".
Cyclical transmission is deactivated so that the centralized feedback is transmitted to the bus only when one of the switching states changes.
- i** The cycle time is defined centrally for all cyclical feedback telegrams on the parameter page "General switching outputs".
- i** No centralized feedback telegram is transmitted during an active delay after bus voltage return, even if a switching state changes during the delay.
- i** A 'flashing' output (see "Disabling function") is always reported back as "switched on".

4.2.4.1.3 Channel-independent functions for blind outputs

Central function for blind outputs

The actuator offers the possibility of linking selected individual or all output channels with a 1-bit central communication object. The behaviour in case of activating an output via the central function is comparable to a central group address linked with all "MOVE operation" objects. The outputs assigned to the central function are activated in accordance with the central object value received. The polarity of the central telegram can, if necessary, be inverted by means of a parameter.

The behaviour of the channels is identical to the 'normal' activation via the "MOVE operation" objects. In this case the central telegram has got the same priority, so the command last received (MOVE or central) will be executed .

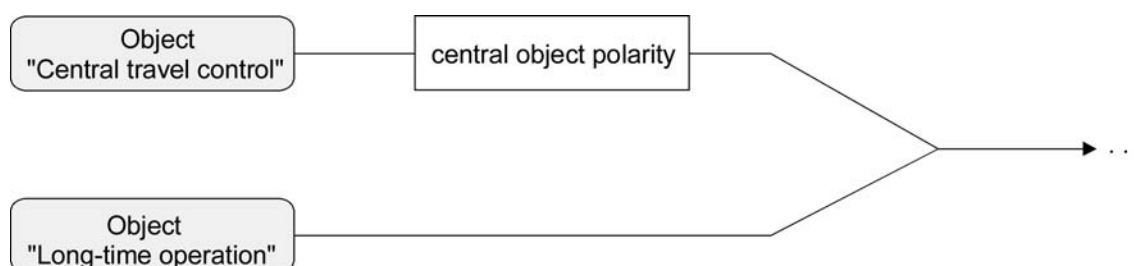

picture 12: Function diagram "Central travel control"

Enabling the central function

- Enable the central function on parameter page "General blind outputs" by setting the "Central function for blind outputs?" parameter to "Yes".
The "Central travel control" communication object is visible.

Assigning outputs to the central function

Each output can be assigned independently to the central function.

The central function must have been enabled on parameter page "General". The assignment has otherwise no effect on the shutter output.

- Set the "Assignment to central function" parameter on parameter page "Ax–Enabled functions" (x = 1/2, 3/4) to "Yes".
The corresponding output is now assigned to the central function. It can be controlled centrally.
- i** The curtain, louver or slat position newly set by the central function is tracked at the end of a travel movement in the feedback objects and also transmitted to the bus, if these are actively transmitting. It should be noted that the actuator can compute positions after application of the supply voltage only if a reference movement into the upper limit positions has been performed beforehand.
- i** The central function belongs to the set of 'direct operations' of an output. For this reason, the central function has the same priority as an operation via STEP or MOVE objects, as the control via the positioning objects or as a scene recall.
- i** After a bus voltage return or after programming with the ETS, the central function is always inactive (object value "0").

Safety functions:

The actuator can handle up to five different safety functions. Each safety function has a communication object of its own so that the functions can be activated or deactivated independently of

one another.

Three different wind alarms are available. These alarms can be used, for instance, to protect shutters or awnings on several building facades from wind and gusts. In addition or as an alternative, a rain alarm, for instance, as a protection for awnings, and a frost alarm as a protection against mechanical damage to lowered shutters in low temperatures can be activated and used. The telegram polarity of the safety objects is fixed: "0" = no alarm / "1" = alarm.

As a rule the communication objects of the safety function are controlled by weather stations that use sensors to record temperature, wind speed and rain.

The safety functions are programmed and configured in common for all shutter/blind outputs. The different outputs of the actuator can be separately assigned to all or to individual safety functions. Only assigned outputs react to a change of state of the safety objects. The reactions at the beginning of an alarm message ("1" telegram) or at the end of an alarm message ("0" telegram) can be parameterized for each channel.

Because outputs can also be assigned to multiple safety alarms, the priority of incoming alarm messages can be set independent of the channel. Thus, the three wind alarms have the same priority with respect to one another (logic OR). The order of priority of the wind alarms with respect to the frost alarm or to the rain alarm can be parameterized.

The communication objects for the safety alarms can be monitored for the arrival of cyclical telegrams. If no telegrams are received within a presettable time, the actuator activates the safety travel movement for the outputs assigned. The safety function is terminated as soon as a new "0" telegram is received.

For the wind alarms, the rain alarm and the frost alarm, different monitoring times between '1 minute' and '23 hours 59 minutes' can be separately selected in the ETS. A common time is configured for the wind alarms. Each wind alarm has its own timer so that the wind objects are separately checked for telegram updates.

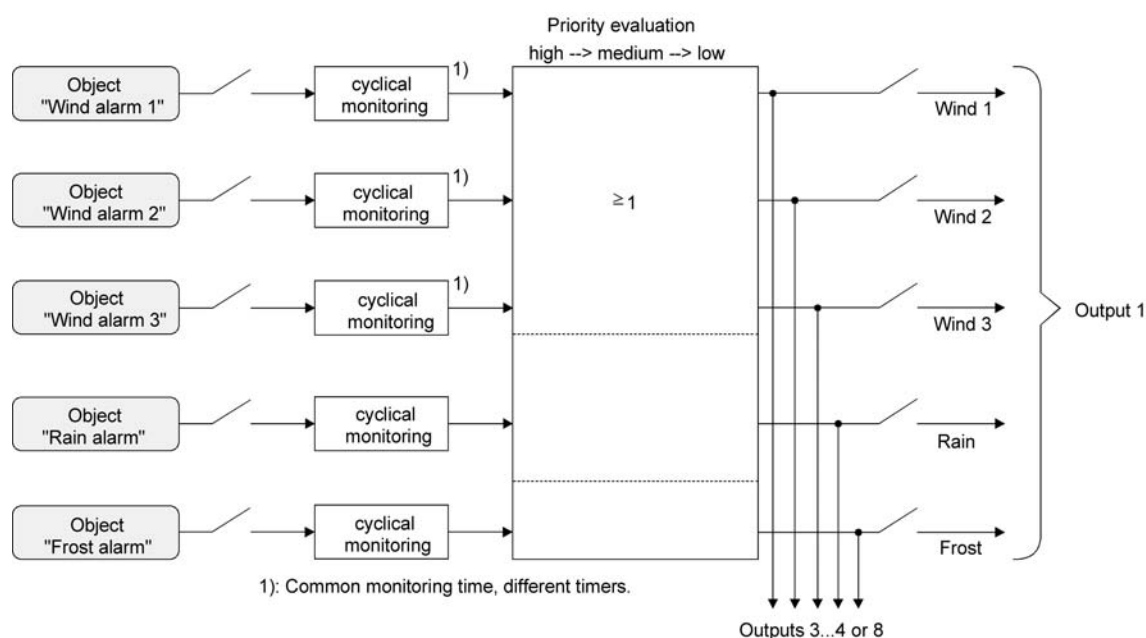

picture 13: Function diagram of the safety function

Enabling the safety functions

The safety functions must first be globally enabled before they can be parameterized and used. After global enabling, the individual safety alarms can be enabled or disabled independently of one another.

- Set the parameter "Safety functions" on the "General blind outputs" parameter page to "enabled".

The safety functions are globally enabled and the other parameters and the parameter page "Safety times" become visible.

- Set the parameters "Wind alarm 1", "Wind alarm 2", "Wind alarm 3", "Rain alarm" and "Frost alarm" depending on functional requirements to "enabled". The "disabled" option deactivates the corresponding alarm.

The necessary safety alarms are now enabled. The safety objects are visible and can be linked with group addresses.

- i** It should be noted that the channel-oriented assignment of blind outputs to the safety alarms (on parameter pages "Ax – Safety"; x = 1/2, 3/4) is operational only after the corresponding alarm has been enabled. Otherwise, an assignment is without function.
- i** An update of the safety objects ("ON" to "ON" or "OFF" to "OFF") shows no reaction.
- i** After failure of the supply voltage (bus and mains voltage failure) or after programming with the ETS, the safety functions are always deactivated. If only the mains voltage or only the bus voltage fails, the object states of the safety functions are not lost and the functions remain activated, if they were activated before. In this case it should be noted, however, that the device executes the parameterized action (parameter "Behaviour after bus or mains voltage return") when the bus or the mains voltage is restored. After such action, the outputs are, however, safety-locked and cannot be operated via the bus anymore unless the safety functions assigned are terminated.

Presetting the safety priorities

If several safety alarms are assigned to an output, it is important to preset the priority of the incoming safety telegrams. An alarm with a higher priority overrides the alarms with the lower priorities. When a safety alarm with the higher priority has ended, the safety alarm with the lower priority is executed on condition that it is active.

The safety functions must have been globally enabled.

- Arrange the "Priority of safety alarms" parameters on the "General blind outputs" parameter page in the required order of priority.
- i** The three wind alarms have the same priority with respect to one another (logic OR). The last telegram update to the wind alarm objects decides which of the wind alarms will be executed. The wind alarm is completely deactivated for an assigned output only after all three objects are inactive ("0").

Presetting cyclical monitoring

If cyclical telegram monitoring of the safety objects is necessary, the individual monitoring functions must be activated separately. The monitoring functions must be enabled and the monitoring times preset on the "Blind safety times" parameter page.

The safety functions must have been globally enabled.

- If monitoring of the wind alarms is to be activated, the parameter "Use wind alarm monitoring function ?" must be set to "yes".
The monitoring function for the wind alarm objects is now activated. As soon as the monitoring function is activated, telegrams must be transmitted cyclically to all enabled wind alarm objects. If only one of the wind alarm telegrams is missing within the monitoring period, the wind alarm reaction will be executed for the output concerned.
- Specify the required monitoring time for the wind alarm objects in the "Time for monitoring wind alarm" parameters.

- If the monitoring function is to be activated for a rain alarm, the parameter "Use rain alarm monitoring function ?" must be set to "yes".
The monitoring function for the rain alarm object is now activated. As soon as the monitoring function is activated, telegrams must be transmitted cyclically to the rain alarm object.

- Specify the required monitoring time for the rain alarm object in the "Time for monitoring rain alarm" parameters.

- If the monitoring function is to be activated for a frost alarm, the parameter "Use frost alarm monitoring function ?" must be set to "yes".
The monitoring function for the frost alarm object is now activated. As soon as the monitoring function is activated, telegrams must be transmitted cyclically to the frost alarm object.
- Specify the required monitoring time for the frost alarm object in the "Time for frost alarm monitoring" parameters.
- i** The monitoring function for the wind alarms may only be activated, if at least one wind alarm has been activated on the "Safety" page.
- i** The cycle time of the transmitters should be shorter than the monitoring time parameterized in the blind actuator in order to ensure that at least one telegram can be received during the monitoring time.

4.2.4.1.4 Channel-independent functions for valve outputs

Behaviour after ETS programming

The state of the valve drives after ETS programming can be set in the ETS in common for the two outputs A5 & A6.

Presetting the behaviour after ETS programming

The parameter "Behaviour of all valve outputs after ETS programming" can be preset independent of the channel on the parameter page "General valve outputs". This parameter can be used to parameterize the behaviour of the valve outputs independently of the behaviour after bus or mains voltage return.

- Set the parameter to "Close valves".

The actuator closes the connected valve drives completely after ETS programming. In this case, the valve direction of action configured in the ETS for each output is taken into account, with the result that the output is switched off for valves that are closed when deenergized, and energized for valves that are open when deenergized.
 - Set the parameter to "Open valves".

The actuator opens the connected valve drives completely after ETS programming. In this case, the valve direction of action configured in the ETS for each output is taken into account, with the result that the output is switched off for valves that are open when deenergized, and energized for valves that are closed when deenergized.
 - Set parameter to "Valves to value for forced position".

The actuator sets the connected valve drives to the value for the forced position (0...100 %) configured in the ETS for each output. With the setting 0 % the output concerned is completely closed, with the setting 100 % completely open. The energization of the valve output is always performed taking into account the preset valve direction of action. With the settings 1...99 % for the forced position value, after ETS programming the actuator carries out PWM on the valve output concerned until a new command value is issued or a different function is specified. In this case the PWM is performed after ETS programming even for valve outputs with a switching command value (1 bit)!
 - Set parameter to "Valves to value for emergency operation".

The actuator sets the connected valve drives to the value for the emergency operation (0...100 %) configured in the ETS for each output. With the setting 0 % the output concerned is completely closed, with the setting 100 % completely open. The energization of the valve output is always performed taking into account the preset valve direction of action. With the settings 1...99 % for the emergency operation value, after ETS programming the actuator carries out PWM on the valve output concerned until a new command value is issued or a different function is specified. In this case the PWM is performed after ETS programming even for valve outputs with a switching command value (1 bit)!
- i** The following must be observed with the settings "Valves to value for forced position" and "Valves to value for emergency operation":
The actuator resorts only to the valve position values (0...100 %) configured in the ETS. The forced position function or emergency operation will not be activated in this case!
The values for forced position and emergency operation are also dependent on the summer/winter mode of the actuator. If mode of operation change-over for the valve outputs is enabled (see "Mode of operation change-over summer/winter mode"), then two separate valve position values for summer and winter mode are configured and distinguished in the ETS.

- i** The parameterized behaviour will be executed after every application or parameter download by the ETS. A simple download of the physical address alone or partial programming of only the group addresses has the effect that this parameter is disregarded and that the parameterized "Behaviour after bus and mains voltage return" will be executed instead. Furthermore, the behaviour after ETS programming is only executed if the bus and mains voltage are connected and switched on after the programming. If only the bus voltage is connected without interruptions, the behaviour is tracked when the mains voltage is switched on. In this case, the behaviour in case of bus or mains voltage return will not be executed. It should be noted that after ETS programming with the mains voltage switched off status telegrams for the command value and the mains failure alarm are transmitted to the bus, if these status messages are actively transmitting or enabled (see chapter 4.2.4.1.1. General channel-independent functions).
- i** After ETS programming, the valve state configured in the ETS is set. In this case the status messages "All valves closed" and "Largest command value feedback" are updated by the room actuator in accordance with the current state, and a telegram is sent to the bus, if the status messaging function is enabled. In addition, the current mains voltage status (mains voltage present / not present is transmitted actively to the bus, if so enabled. The transmission of the status telegrams and messages only takes place, however, after the end of the "Delay after bus voltage return" configured in the ETS.
- i** A valve state set after ETS programming will be tracked in the feedback object.
- i** ETS programming will terminate the manual mode, if active.

Mode of operation change-over summer/winter mode

For the forced position function and for emergency operation, constant valve position values (0...100 %) can be configured in the ETS separately for each output. If a forced position or emergency operation has been activated, the room actuator transmits the specified valve position to the valve outputs concerned by means of pulse-width modulation.

For these functions in the room actuator it is possible to preset in the ETS different valve position values for summer and winter. Thus, for example, emergency operation that has been activated for a fault in the course of command value monitoring can effect a different valve opening in summer mode than in winter mode. Furthermore, a separate valve position preset can also be distinguished for a forced position depending on the season.

Enabling mode of operation change-over

In order for the room actuator to distinguish between two summer and winter valve position values for the forced position function and emergency operation, mode of operation change-over must be enabled in the ETS.

- Set the parameter "Summer/winter mode change-over ?" on the parameter page "General valve outputs" to "Yes".

The mode of operation change-over for summer and winter mode is enabled. The 1-bit communication object "Summer/winter change-over" becomes visible in the ETS. This object can be used to change the mode of operation of the room actuator a any time by means of a bus telegram.

In addition, the ETS automatically makes further parameters visible on the parameter pages "A5 - General" and "A6 - General", so that separate valve position values for summer and winter for the forced position function and for emergency operation can be configured.

- Set the parameter "Summer/winter mode change-over ?" on the parameter page "General valve outputs" to "No".

The mode of operation change-over for summer and winter mode is disabled. Only one valve position value can be set in the ETS per output separately for the forced position function and for emergency operation. No distinction is made between summer and winter mode.

- i** In the state of the room actuator as supplied, summer/winter mode of operation change-over is deactivated. The actuator then operates with only one valve position value for forced position and emergency operation.

Setting the telegram polarity for mode of operation change-over

The telegram polarity of the 1-bit communication object "Summer/winter change-over" can be set in the ETS.

Mode of operation change-over must have been enabled already.

- Set the parameter "Polarity of "Summer/winter change-over" object" on the parameter page "General valve outputs" to "Summer = 0 / Winter = 1".
Summer mode is activated by an "OFF" telegram, and winter mode by an "ON" telegram.
- Set the parameter "Polarity of "Summer/winter change-over" object" on the parameter page "General valve outputs" to "Summer = 1 / Winter = 0".
Summer mode is activated by an "ON" telegram, and winter mode by an "OFF" telegram.

- i** If there is a failure of only the bus voltage or only the mains voltage, the value of the communication object "Summer/winter change-over" is maintained, and thus so is the mode of operation. Thus in the event of a bus voltage failure the mode of operation that was last specified via the communication object "Summer/winter change-over" will be used. If at the time of the bus voltage failure no mode of operation has been specified via the bus, then the room actuator resorts to the "Mode of operation after device reset" configured in the ETS. The object state after a device reset (ETS programming, bus or mains voltage return) can be set separately in the ETS (see "Presetting the mode of operation after device reset").

- i** The mode of operation can also be changed via the object while emergency operation or a forced position function is activated. In this case the room actuator adjusts the pulse-width modulation to the valve position value of the valid mode of operation immediately after the change-over.

In addition, the value for the emergency operation and the value for the forced position after ETS programming, after bus voltage failure or after bus or mains voltage return can be adopted as a valve position value, and pulse-width modulation started. In this case the actuator resorts only to the valve position values (0...100 %) configured in the ETS, taking into account the preset or tracked mode of operation. The forced position function or emergency operation are not activated in this case, so that a change-over of the mode of operation after one of the above-mentioned events does not lead to a change-over of the summer/winter valve position.

Presetting the mode of operation after device reset

The value of the communication object "Summer/winter change-over" is initialised automatically by the room actuator after ETS programming and after bus or mains voltage return. The initialisation value is configured in the ETS.

Mode of operation change-over must have been enabled already.

- Set the parameter "Mode of operation after ETS programming" on the parameter page "General valve outputs" to "Summer mode".
The summer mode is initialised immediately after ETS programming or after bus or mains voltage return.
- Set the parameter "Mode of operation after ETS programming" on the parameter page "General valve outputs" to "Winter mode".
The winter mode is initialised immediately after ETS programming or after bus or mains voltage return.

- i** The mode of operation set after a device reset is also tracked in the "Summer/winter change-over", taking into account the configured telegram polarity, and can be read out (set "R"-flag).

Status message "All valves closed"

The room actuator can use a 1-bit status telegram to transmit to the bus the information that all valves are closed, i.e. that no heating or cooling energy is being demanded via the command values of both valve outputs. This status message can be useful, for example, for visualisation purposes or for controlling pumps in a heating/cooling system.

Enabling status message "All valves closed"

The status message can be enabled in common for the two valve outputs of the room actuator on the parameter page "General valve outputs".

- Set the parameter "Status object 'All valves closed'" to "enabled".
The status function "All valves closed" is enabled. The communication object "All valves closed" is visible in the ETS.
- Set the parameter "Status object 'All valves closed'" to "disabled".
The status function "All valves closed" is completely deactivated.

Setting telegram polarity for status message "All valves closed"

The telegram polarity of the 1-bit communication object "All valves closed" can be set in the ETS.

The status message must have been enabled.

- Set the parameter "Polarity of 'All valves closed' object" on the parameter page "General valve outputs" to "object value in case of 'All valves closed' = 0".
As soon as all valve positions have been preset or adjusted to "0 %" or "OFF", i.e. all valves are completely closed, the room actuator transmits an "OFF" telegram to the bus via the status object. As soon as only one valve on a valve output is opened via a switching command value or via any pulse-width modulation, the actuator transmits an "ON" status telegram to the bus.
- Set the parameter "Polarity of 'All valves closed' object" on the parameter page "General valve outputs" to "object value in case of 'All valves closed' = 1".
As soon as all valve positions have been preset or adjusted to "0 %" or "OFF", i.e. all valves are completely closed, the room actuator transmits an "ON" telegram to the bus via the status object. As soon as only one valve on a valve output is opened via a switching command value or via any pulse-width modulation, the actuator transmits an "OFF" status telegram to the bus.

- i** The status message takes into account valve outputs with switching and constant command values.

- i** The valve state configured in the ETS is set after bus or mains voltage return or after ETS programming. In this case the status message "All valves closed" is updated by the room actuator in accordance with the current state, and a telegram is sent to the bus, if the status messaging function is enabled.
In these cases, however, this transmission only takes place after the end of the "Delay after bus voltage return" configured in the ETS.

- i** In the event of a failure of the mains voltage on the actuator or a short-circuit on a valve output, the connected valve drives are no longer controlled electrically, so that the drives enter the deenergized state preset by the manufacturer (open or closed in deenergized state).
A valve which is completely open due to a mains voltage failure or short-circuit (valve direction of action open in deenergized state) is evaluated like a closed valve for the status message "All valves closed", because the valve state was caused by a fault.

Feedback of the largest command value

With some condensing furnaces, the information about the largest heating command value in the heating circuit may be necessary in order to determine the optimal inlet temperature for the heating circuit.

Exclusively for valve outputs with a constant command value the room actuator determines the largest 1-byte nominal command value in the actuator. The actuator can transmit this largest command value to the bus via a separate 1-byte communication object "Largest command value feedback".

Not just the command values received via the bus are evaluated in this feedback function. The room actuator also takes into account states of open valves that were set using manual control or a special function (forced position, emergency operation, behaviour in case of bus voltage failure and in case of bus or mains voltage return / behaviour after ETS programming).

Valve outputs with a switching 1-bit command value are not taken into account in the determination of the largest command value, even if these outputs are executing pulse-width modulation (for example during manual control or a forced position).

Enabling feedback of the largest command value

The feedback of the largest command value can be enabled in common for the two valve outputs of the room actuator on the parameter page "General valve outputs".

- Set the parameter "Only for constant 1 byte valve outputs: Feedback of the largest command value" to "enabled".

The feedback function is enabled and the communication object "Largest command value feedback" becomes visible in the ETS. The actuator transmits a feedback telegram as soon as the largest active command value changes, e.g. when a valve opens. If the valves on both valve outputs are completely closed, the feedback transmits the value "0".

- Set the parameter "Only for constant 1 byte valve outputs: Feedback of the largest command value" to "disabled".

The feedback function for the largest command value is completely deactivated.

- i** If both valve outputs are parameterized to 1-bit command values, the feedback of the largest command value is always "0".
- i** The valve state configured in the ETS is set after bus or mains voltage return or after ETS programming. In this case the "Largest command value feedback" is also updated by the room actuator in accordance with the current state, and a telegram is sent to the bus, if the feedback function is enabled.
In these cases, however, this transmission only takes place after the end of the "Delay after bus voltage return" configured in the ETS.

- i** In the event of a failure of the mains voltage on the actuator or a short-circuit on a valve output, the connected valve drives are no longer controlled electrically, so that the drives enter the deenergized state preset by the manufacturer (open or closed in deenergized state).
A valve which is completely open due to a mains voltage failure or short-circuit (valve direction of action open in deenergized state) is evaluated like a closed valve for the "Largest command value feedback", because the valve state was caused by a fault.

Anti-sticking protection

The room actuator has an automatic anti-stick protection function in order to prevent "furring up" or sticking of a valve that has not been activated for a longer period. If it is enabled in the ETS, the anti-stick protection always takes effect simultaneously for both valve outputs.

Enabling anti-sticking protection

The anti-sticking protection can be enabled globally for both valve outputs the parameter page "General valve outputs".

- Set the parameter "Anti-sticking protection" to "enabled".
The anti-sticking protection is activated simultaneously for both valve outputs cyclically every 6 days independently of the current mode of operation and the active valve position. To do this, the room actuator switches both valve outputs on for a period of approx. 5 minutes. After this switch-on phase the actuator switches all valve outputs off for a period of approx. 5 minutes. This ensures that all valves, regardless of whether they are open in deenergized state or closed in deenergized state, are opened and closed almost completely, thus 'running through' the entire valve travel path once.
After the anti-sticking protection the actuator once controls the outputs again according to the preset mode of operation.
 - Set the parameter "Anti-sticking protection" to "disabled".
The anti-sticking protection is completely deactivated and will not be executed.
- i** The anti-sticking protection is always carried out 'in the background' independent of the bus voltage, and is not reported to the bus via the status objects. The status LEDs on the front panel of the device continue to show the energization state of the individual valve outputs even during the anti-sticking protection function.
- i** The cycle time of the anti-sticking protection is only restarted after the supply voltage of the actuator is switched on again completely (bus and mains voltage return), or the device has been reprogrammed via the ETS. This means that in these cases at least approx. 6 days have to pass before the anti-sticking protection will be carried out automatically for the first time.
- i** The anti-sticking protection has a higher priority than a forced position or emergency operation. Like normal operation via command values, these operating states are overridden by the anti-sticking protection.
On the other hand, manual control (temporary or permanent) overrides the anti-sticking protection. If anti-sticking protection is to be carried out (because the 6-day timer has elapsed) while manual control is active, the room actuator does not activate the anti-sticking protection, but it does start the 2 x 5 minute ON-OFF time of the protection. If the manual control is terminated before the ON-OFF time of the anti-sticking protection has elapsed, then the room actuator will subsequently carry out the anti-sticking protection for the remaining time.

4.2.4.2 Channel-oriented functional description

4.2.4.2.1 Functional description for relay switching outputs

Mode of operation

The relays of a switching output can be parameterized as NO or NC contacts. This feature makes it possible to invert the switching states. The preset mode of operation has consequences for the switching state feedback function.

Presetting the mode of operation

The parameter "Mode of operation" can be preset separately for each output channel on the parameter page "Ax General" (x = number of the switching output).

- Program the relay contact as NO contact.
Switching state = off ("0") -> relay contact open,
Switching state = on ("1") -> relay contact closed.
- Program the relay contact as NC contact.
Switching state = off ("0") -> relay contact closed,
Switching state = on ("1") -> relay contact open.

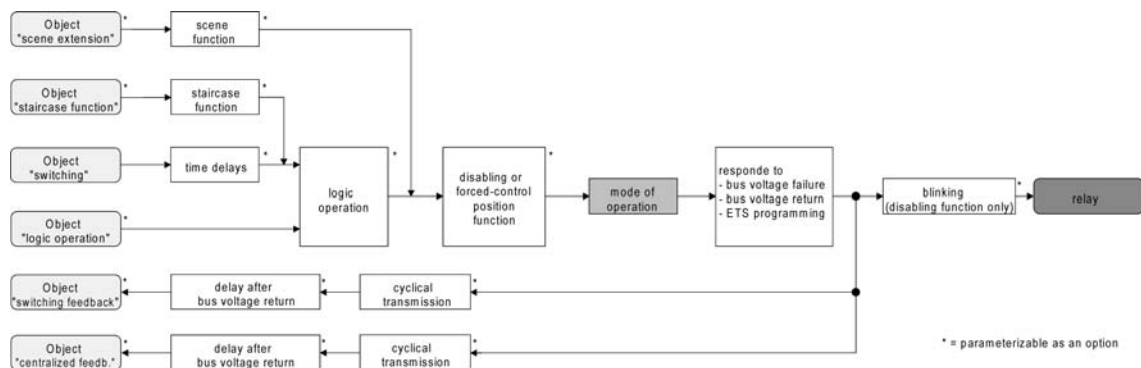

picture 14: Function diagram "Mode of operation"

- i** The logical switching state ("on – 1" or "off – 0") can be set via the communication object "Switching", and is affected by the functions that can optionally be activated (e.g. time/staircase functions, logic operations, disabling/forced position functions, scenes).
- i** A switching state set after bus/mains voltage return or after ETS programming will be tracked in the feedback object. In case of a mains voltage failure, switching status feedback telegrams are transmitted to the bus, if the bus voltage is still switched on. In this case it should be noted that independent of the preset mode of operation (NO or NC contact), all outputs are initialised with the switching state "switched off - 0", and thus the feedback telegram is also adjusted to this state.

Behaviour in case of bus voltage failure, after bus or mains voltage return or after programming with the ETS

The preferred relay contact positions after bus voltage return or after ETS programming can be preset separately for each output. Since the actuator is equipped with mains-dependent mono-stable relays, the relay switching state at bus voltage failure can be defined as well.

Presetting the behaviour after ETS programming

The parameter "Behaviour after ETS programming" can be preset separately for each output channel on the parameter page "Ax General" (x = number of the switching output). This parameter can be used to parameterize the relay behaviour of the output independently of the behaviour after bus voltage return.

- Set the parameter to "no reaction".
After ETS programming the relay of the output shows no reaction and remains in the switching state last set. The internal logical switching state is not lost as a result of ETS programming.
- Set the parameter to "close contact".
The relay contact is closed after ETS programming.
- Set the parameter to "open contact".
The relay contact is opened after ETS programming.
- i** The parameterized behaviour will be executed after every application or parameter download by the ETS. A simple download of the physical address alone or partial programming of only the group addresses has the effect that this parameter is disregarded and that the parameterized "Behaviour after bus or mains voltage return" will be executed instead.
- i** ETS programming can be performed as soon as the bus voltage is connected to the room actuator and switched on. The mains voltage supply is not required for an ETS download.
- i** During each ETS programming cycle, the room actuator always opens the relay contacts for all outputs. For this reason, as closed relay contact can be opened temporarily even with the setting "no reaction".
- i** A switching state set after ETS programming will be tracked in the feedback object depending on the "Mode of operation" parameter.
- i** ETS programming will terminate the manual mode, if active.
- i** After ETS programming, the disabling functions and the forced positions are always deactivated.

Presetting the behaviour in case of bus voltage failure

The parameter "Behaviour in case of bus voltage failure" can be preset separately for each output channel under "Ax General" (x = number of the switching output).

- Set the parameter to "no reaction".
In the event of bus voltage failure the relay of the output shows no reaction and remains in the switching state last set, as long as the mains voltage of the actuator is still switched on.
- Set the parameter to "close contact".
In the event of bus voltage failure the relay contact closes, as long as the mains voltage of the actuator is still switched on.
- Set the parameter to "open contact".
The relay contact is opened on bus voltage failure.
- i** With the settings "close contact" and "open contact", time delays previously activated or delayed scenes previously called up have no effect on the output concerned in the event of a bus voltage failure. A telegram update received shortly before bus voltage failure is then lost, if the corresponding delay has not yet elapsed.
With the setting "no reaction", delay times (time delay, delayed scene recall) started before the bus failure are also still evaluated after failure of the bus voltage, if the mains voltage is still switched on. This means that the state of an input can still change after a bus failure.

- i** In the event of a failure of the mains voltage supply, all relays of the actuator always drop out (contact open), regardless of the state of the bus voltage. In this state the outputs can no longer be activated. Time functions (scenes, time delays) are not interrupted if only the mains voltage fails.
In case of a mains voltage failure, switching status feedback telegrams are transmitted to the bus, if the bus voltage is still switched on. In this case it should be noted that independent of the preset mode of operation (NO or NC contact), all outputs are initialised with the switching state "switched off", and thus the feedback telegram is also adjusted to this state.
- i** In case of bus or mains voltage failure the current states of the forced positions are also stored, so that they can be tracked if necessary after bus voltage return (depending on the parameterization of the forced position functions).
- i** Active disabling or forced position functions are always cancelled by a bus voltage failure, and are subsequently inactive.

Presetting the behaviour after bus or mains voltage return

The parameter "Behaviour after bus or mains voltage return" can be preset separately for each output channel on the parameter page "Ax General" (x = number of the switching output).

- Set the parameter to "close contact".
The relay contact closes after bus or mains voltage return.
- Set the parameter to "open contact".
The relay contact opens after bus or mains voltage return.
- Set parameter to "state as before bus/mains voltage failure".
After bus or mains voltage return, the switching state last existing and internally stored before bus/mains voltage failure will be tracked.
- Set the parameter to "Activate staircase function (if parameterized)".
The staircase function is activated after bus or mains voltage return – independent of the object "Switching". In this setting it should be ensured that the staircase function is also enabled and configured. If the staircase function is not enabled, this setting will not show any reaction after bus/mains return.
- Set the parameter to "no reaction".
After bus or mains voltage return the relay of the output shows no reaction and remains in the switching state last set.
- i** For setting "state as before bus/mains voltage failure": ETS programming of the application or of the parameters resets the internally stored switching state to "off".
- i** The device executes the parameterized "Behaviour after bus or mains voltage return" only if more than approx. 20 s have elapsed between the last ETS programming of the application or of the parameters and the time when the bus voltage is restored. Otherwise ($T_{ETS} < 20$ s) the "Behaviour after ETS programming" will be executed also in case of a bus voltage return.
If only the mains voltage fails after an ETS download and is then restored, the actuator executes the "Behaviour after bus or mains voltage return".
Mains voltage return does not affect the communication objects that receive states from the bus (e.g. logic operation inputs). The objects remain in the state last set, if the bus voltage was connected without interruptions.
- i** "No reaction" setting: On return of bus voltage, the switching state will be internally set back to "switched off - 0" independent of the position of the relay contacts. The feedbacks will also be initialised this way, if applicable even in inverted form.
In this case the switching status feedback corresponds to the 'true' relay status, if the outputs were once activated via the bus.
- i** A switching state set after bus or mains voltage return will be tracked in the feedback object depending on the "Mode of operation" parameter.

- i** In case of forced position as supplementary function: The communication object of the forced position function can be initialised separately after bus voltage return. This has an effect on the reaction of the output when the forced position is activated. The parameterized "Behaviour in case of bus or mains voltage return" will only be executed if no forced position is activated after bus voltage return.
A failure of the mains voltage of the actuator always deactivates a forced position.
- i** For blocking function as supplementary function: Active disabling functions are always inactive after bus or mains voltage return.
- i** An active manual control is terminated on return of bus voltage. In case of mains failure, no manual control is possible.

Switching status feedback

The actuator can report to the bus the switching status ("switched on" or "switched off" set at the output (see picture 15). The feedback value can optionally be inverted.

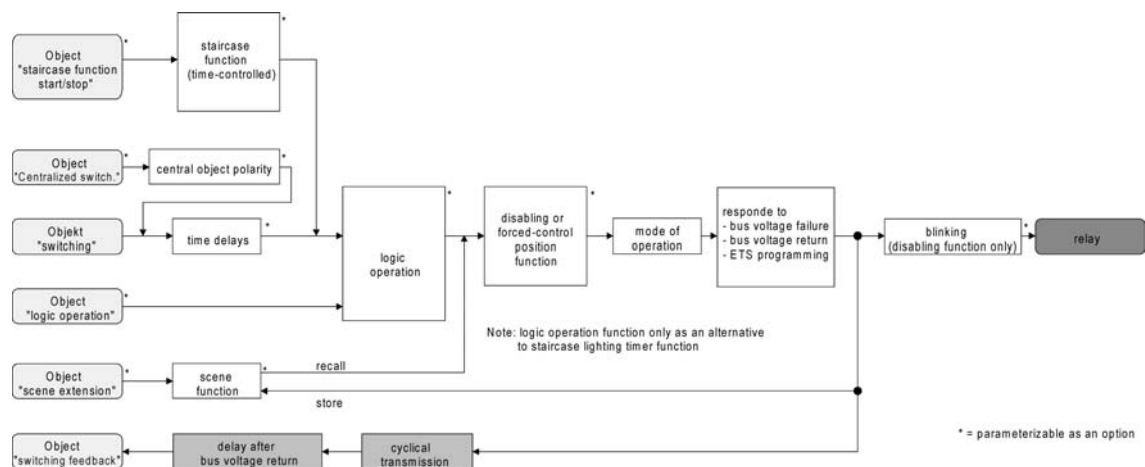

picture 15: Functional diagram of feedback

Activating the switching status feedback function

The switching status feedback can be used as an active signalling object or as a passive status object. As an active signalling object, the switching status feedback information is transmitted to the bus whenever a switching state changes. As a passive status object, there is no telegram transmission after a change. In this case, the object value must be read out. The ETS automatically sets the object communication flags required for proper functioning.

The parameter "Feedback ?" can be preset separately for each output channel on the parameter page "Ax General" (x = number of the switching output).

- Set the parameter to "no inversion, active signalling object" or to "inversion, active signalling object".

The feedback object is enabled. Depending on the selected setting, the switching status is transmitted in non-inverted or inverted form as soon as there is a change in the state or after the device has been programmed via the ETS. Telegram transmission of the switching status feedback also takes place after bus or mains voltage return.

- Set the parameter to "no inversion, passive status object" or to "inversion, passive status object".

The feedback object is enabled. The switching status will be transmitted in response only if the feedback object is read out by the bus. No automatic telegram transmission takes place after bus or mains voltage return or after ETS programming.

- i** Updates "ON" to "ON" or "OFF" to "OFF" via the object "Switching" or via the object "Central switching" also always launch telegram transmission of the feedback with actively transmitting objects. If a time delay is set, then in the event of a switching state change-over via the object "Switching" the feedback will not be updated until the delay time has elapsed.

- i** Changes in switching states via manual control are also reported back to the bus.
- i** For blocking function as supplementary function: A 'flashing' output is always reported back as "switched on". Switching status feedback telegrams are also transmitted for disabled outputs, if, for example, the outputs are changed using manual control.

Activating switching status feedback on return of bus voltage or after ETS programming

The state of the switching status feedback is transmitted to the bus after bus voltage return or after ETS programming when used as an active signalling object. In these cases the feedback telegram can be transmitted with a time, with the delay being preset globally for all outputs in common (see "Delay after bus voltage return").

- Set the parameter "Time delay for feedback after bus voltage return" on parameter page "Ax General" (x = number of the switching output) to "Yes".
The switching status feedback will be transmitted with a delay after bus voltage return or after ETS programming. No feedback telegram is transmitted during a running delay, even if a switching state changes during this delay.
- Set the parameter "Time delay for feedback after bus voltage return" on parameter page "Ax General" to "No".
The switching status feedback will be transmitted immediately after bus voltage return or after ETS programming.
- i** In case of feedback after bus voltage return or after ETS programming, the parameterized mode of operation will be evaluated immediately. Examples for a non-inverted switching status feedback:
Mode of operation NO contact: close contact = feedback "switched on",
Mode of operation NO contact: open contact = feedback "switched off",
Mode of operation NC contact: close contact = feedback "switched off",
Mode of operation NC contact: open contact = feedback "switched on",
- i** When the mains voltage is switched on (the bus voltage is already switched on), feedback telegrams are always transmitted without any delay.

Presetting the cyclical transmission function for the switching status feedback

In addition to being transmitted in case of a state change, the switching status feedback telegram can also be transmitted cyclically via the active signalling object.

- Set the parameter "Cyclical transmission of the feedback?" on the parameter page "Ax General" (x = number of the switching output) to "Yes".
Cyclical transmission is now activated.
- Set the parameter "Cyclical transmission of the feedback?" on the parameter page "Ax General" (x = number of the switching output) to "No".
Cyclical transmission is deactivated so that the feedback is transmitted to the bus only when one of the switching states changes.
- i** The cycle time is defined centrally on the parameter page "Switching output times".
- i** During an active delay after bus voltage return no feedback telegram will be transmitted even if a switching state changes.

Time delays

For each switching output, up to two time functions can be preset independently of each other. The time functions affect exclusively the communication objects "Switching" or "Central switching" (if a central function is activated for the output concerned), and delay the received object value depending on the telegram polarity (see picture 16).

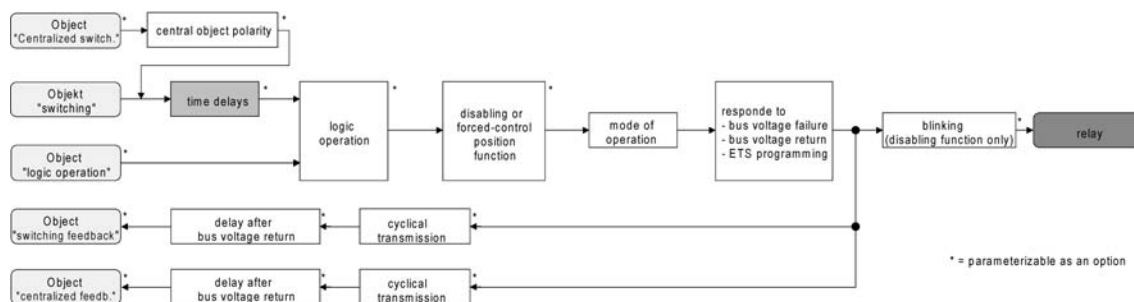

picture 16: Functional diagram of the time delays

Activating a switch-on delay

The time delays must be enabled on parameter page "Ax – Enabled functions" (x = number of switching output).

- On parameter page "Ax – Time delays", set the parameter "Selection of time delay" to "Switch-on delay" or to "Switch-on and switch-off delay".

The switch-on delay is enabled. The desired switch-on delay time can be preset. A parameterizable time is started when an ON telegram is received. An additional ON telegram will only retrigger the time if the parameter "Switch-on delay retriggerable ?" is set to "Yes". Only when the switch-on delay elapses will the logical switching state be forwarded to the following functions (e.g. logic operation, disabling/forced position function), and the output switched on if necessary. An OFF telegram during the switch-on delay terminates the delay. In this case the logical switching state is "switched off".

Activating a switch-off delay

The time delays must be enabled on parameter page "Ax – Enabled functions" (x = number of switching output).

- On parameter page "Ax – Time delays", set the parameter "Selection of time delay" to "Switch-off delay" or to "Switch-on and switch-off delay".

The switch-off delay is enabled. The desired switch-off delay time can be preset. A parameterizable time is started when an OFF telegram is received. An additional OFF telegram will only retrigger the time if the parameter "Switch-off delay retriggerable ?" is set to "Yes". Only when the switch-off delay elapses will the logical switching state be forwarded to the following functions (e.g. logic operation, disabling/forced position function), and the output switched off if necessary. An ON telegram during the switch-off delay terminates the delay. In this case the logical switching state is "switched on".

- i** Feedback: If a time delay is set, then in the event of a switching state change-over the feedback telegrams will not be transmitted until the delay time has elapsed. An object update due to retriggering of "ON" to "ON" or from "OFF" to "OFF" while a delay time is active has no effect on the feedback of the switching status.
- i** At the end of a disabling or forced position function, the state received during or set before the function can be tracked. Residual times of time functions are tracked, if they have not completely elapsed when the disabling or forced control function is terminated. In case of a logic operation function, a switching state newly received via the "Switching" object will be executed with a time delay as well.
- i** The time delays have no influence on the staircase function, if it is enabled.
- i** A time delay in progress will be completely terminated by a reset of the actuator (bus voltage failure or ETS programming).

Staircase function

The staircase function can be parameterized for each output separately and used for realizing time-controlled staircase lighting or functionally similar applications. In order for the required communication objects and parameters (on parameter page "Ax – Staircase function") to be visible, the staircase function must have been enabled for each output on parameter page "Ax – Enabled functions".

The staircase function is controlled via the communication object "Staircase function start/stop", and is independent of the object "Switching" of the output (see picture 17). In this manner 'parallel operation' of time and normal control is possible, with the last command received always being executed:

A telegram to the object "Switching" or a scene recall at the time of an active staircase function terminates the staircase function prematurely and sets the switching state in accordance with the received object value (also taking time delays into account) or the scene value. Similarly, the switching state of the object "Switching" or a scene recall can be overridden by a staircase function.

The staircase function can also be combined with other functions of the output in accordance with the function diagram. Combination with the logic operation function is not possible, however.

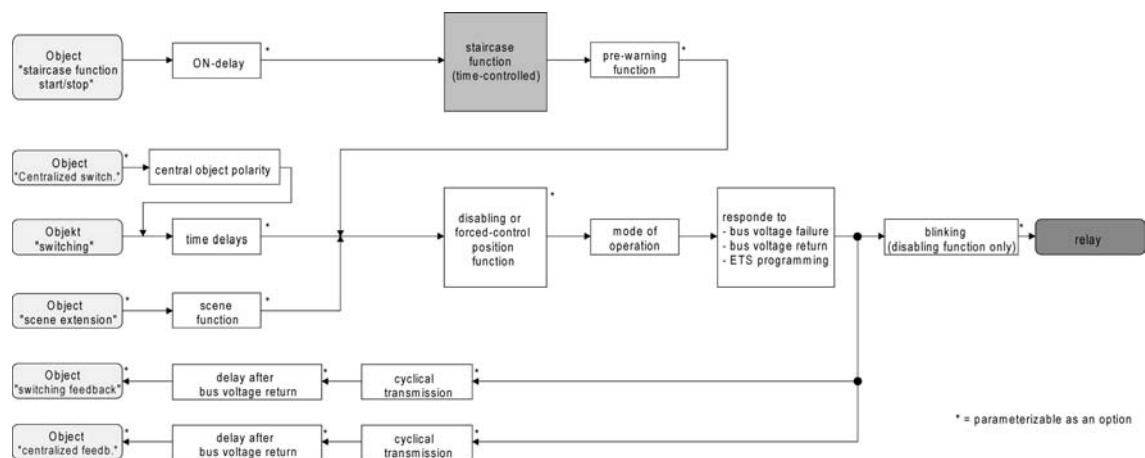

picture 17: Functional diagram of the staircase function

The staircase function can be enlarged a supplementary functions. In this case it is possible on the one hand to activate a time extension. The "time extension" can be used to retrigger an activated staircase time n times via the object "Staircase function start/stop". Alternatively the "time preset via the bus" can be set. With this supplementary function, the parameterized staircase time can be multiplied with a factor received from the bus and thus dynamically adapted. In addition, the staircase function can be enlarged with separate switch-on delay and a pre-warning function. In accordance with DIN 18015-2, the pre-warning should warn any person still on the staircase that the light will be switched off soon.

Defining the switch-on behaviour of the staircase function

An ON telegram to the object "Staircase function start/stop" activates the staircase time (T_{ON}), whose length is defined by the parameter "Staircase time". In addition it is possible to activate a switch-on delay (T_{Del}) (see "Presetting the switch-on delay for the staircase function"). At the end of the staircase time the output switches off or optionally activates the pre-warning time ($T_{Pre-warn}$) of the pre-warning function (see "Presetting the pre-warning function of the staircase function"). Taking into account a possible switch-on delay and a pre-warning function, the result is the switch-on behaviour of the staircase function shown in the following illustration.

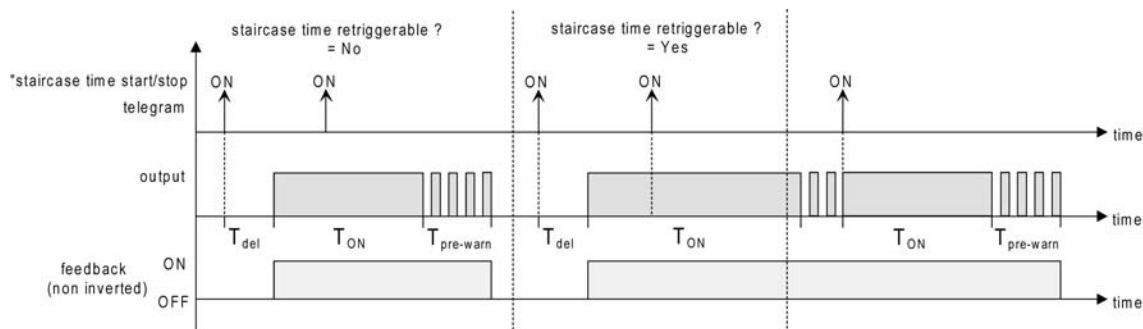

picture 18: Switch-on behaviour of the staircase function

The parameter "Staircase time retriggerable ?" defines whether the staircase time can be retriggered.

The staircase function must be enabled on parameter page "Ax – Enabled functions" (x = number of switching output).

- Set the parameter "Staircase time retriggerable ?" to "Yes".
Every ON-telegram received during the ON-phase of the staircase lighting time retriggers the staircase time completely.
- Set the parameter "Staircase time retriggerable ?" to "No".
ON-telegrams received during the ON-phase of the staircase time will be rejected. The staircase lighting time will not be retriggered.
- i** An ON-telegram received during the pre-warning time always retriggers the staircase lighting time independent of the "Staircase time retriggerable ?" parameter.
- i** If the supplementary function "Time extension" is active, the "Staircase time retriggerable ?" parameter cannot be changed. In this case, the parameter is set to "No" and cannot be changed.

Defining the switch-off behaviour of the staircase function

For a staircase function it is also possible to parameterize the reaction to an OFF telegram to the object "Staircase function start/stop". If no OFF telegram is received, the output may switch off when the pre-warning time elapses. Taking into account a possible switch-on delay and a pre-warning function, the result is the switch-off behaviour of the staircase function shown in the following illustration.

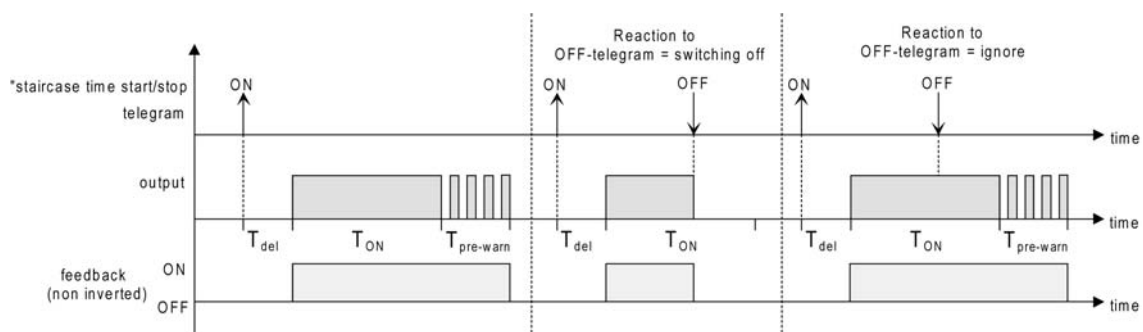

picture 19: Switch-off behaviour of the staircase function

The parameter "Reaction to OFF-telegram" defines whether the staircase time (T_{ON}) of the staircase function can be stopped prematurely.

The staircase function must be enabled on parameter page "Ax – Enabled functions" (x = number of switching output).

- Set the parameter "Reaction to OFF-telegram" to "switch off".
During the ON phase of the staircase time, the output switches off immediately as soon as an OFF telegram is received via the "Staircase function start/stop". Premature termination of the staircase time in this manner takes place without a pre-warning, i.e. the pre-warning time is not started.
- Set the parameter "Reaction to OFF-telegram" to "Ignore".
OFF-telegrams received during the ON-phase of the staircase time will be rejected. The staircase time will be executed completely, if applicable with a pre-warning.
- i** In the supplementary function "Time preset via the bus" the staircase time of the staircase function can also be started by the receipt of a new time factor (cf. "Presetting the supplementary function of the staircase function Time preset via the bus"). In this case received "0" factors are interpreted like an OFF telegram. In this case, too, the parameter "Reaction to OFF telegram" is evaluated, so that a staircase time can be stopped prematurely.

Presetting the switch-on delay for the staircase function

An ON-telegram to activate the staircase function can also be evaluated with a time delay. This switch-on delay can be activated separately for the staircase function and has no influence on the parameterizable time delays for the "Switching" object.

The staircase function must be enabled on parameter page "Ax – Enabled functions" (x = number of switching output).

- Set the parameter "Switch-on delay for the staircase function ?" on parameter page "Ax – Staircase function" to "Yes".
The switch-on delay for the staircase function is enabled. The desired switch-on delay time can be preset. When an ON telegram to the object "Staircase function start/stop" is received, the switch-on delay is started. An additional ON telegram will only retrigger the time if the parameter "Switch-on delay retriggerable ?" is set to "Yes". Only after the end of the time delay will the staircase time be activated and the output switched on.
- i** An OFF-telegram via the "Staircase function start / stop" object during the switch-on delay ends the delay only if the parameter "Reaction to OFF-telegram" is set to "switch off". Otherwise the OFF-telegram will be ignored.
- i** If the supplementary function "Time extension" is set, the "Switch-on delay retriggerable ?" parameter cannot be changed. In this case, the parameter is set to "No" and cannot be changed.

Presetting the pre-warning function of the staircase function

In accordance with DIN 18015-2, the pre-warning should warn any persons still on the staircase that the light will be switched off soon. As a pre-warning the lighting connected to the output is switched off briefly a number of times before the output is switched off permanently. The pre-warning time ($T_{\text{Pre-warn}}$), the duration of the interruptions during the pre-warning ($T_{\text{Interrupt}}$) and the number of pre-warning interruptions can be parameterized (see picture 20). The pre-warning time is added to the staircase time (T_{EIN}). The pre-warning time influences the value of the feedback object, so that in the feedback object the value "0" is only tracked after the end of the pre-warning time.

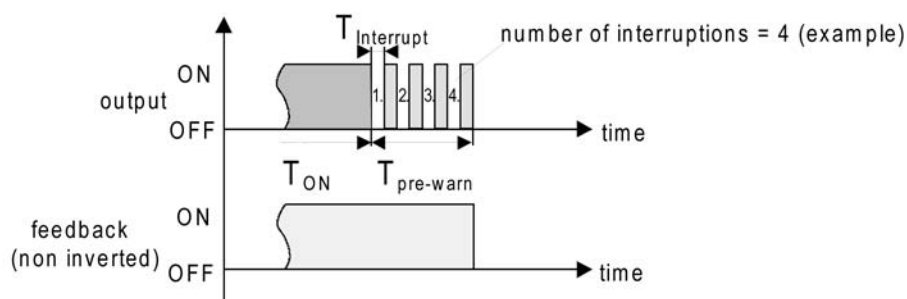

picture 20: The pre-warning function of the staircase function (example)

- Set the parameter "Activate pre-warning time ?" on parameter page "Ax – Staircase function" to "Yes".

The pre-warning function is enabled. The desired pre-warning time ($T_{\text{Pre-warn}}$) can be set.
 - Set the parameter "Number of pre-warnings" on parameter page "Ax – Staircase function" to the desired value (1...10).

Within the pre-warning time the lighting connected to the output will be switched off for exactly the number of times set in this parameter. The 1st pre-warning is always executed at the beginning of the entire pre-warning time.
 - Set the parameter "Time for pre-warning interruptions" on parameter page "Ax – Staircase function" to the desired value.

An interruption ($T_{\text{Interrupt}}$) during the pre-warning time is exactly as long as programmed in this parameter. A presettable interruption time permits adapting the shut-off phase of the lighting individually to the lamp type used.
- i** It must be ensured that the "Number of pre-warnings" and the "Time for pre-warning interruptions" are coordinated with the length of the total "pre-warning time". Thus, the total shut-off phase during a pre-warning ("Number of pre-warnings" + "Time for pre-warning interruptions") must not be chosen longer than the pre-warning time itself. Otherwise risk of malfunctions.
- i** An ON telegram to the object "Staircase function start/stop" during an active pre-warning function stops the pre-warning time and always retriggers the staircase time (independent of the parameter "Staircase time retriggerable ?"). In the pre-warning time, too, the parameter "Reaction to OFF telegram" is evaluated, so that an active pre-warning can be stopped prematurely by means of switching-off.

Supplementary function of the staircase function – setting the time extension

The time extension can be used to retrigger, i.e. extend, the staircase time a number of times via the object "Staircase function start/stop". The length of the time extension is preset by means of repeated operation of a control section (a number of ON telegrams in succession). In this manner the parameterized staircase time can be extended by up to the parameterized factor (maximum 5-fold). The extension then always takes place automatically at the end of a simple staircase time (T_{ON}) (see picture 21).

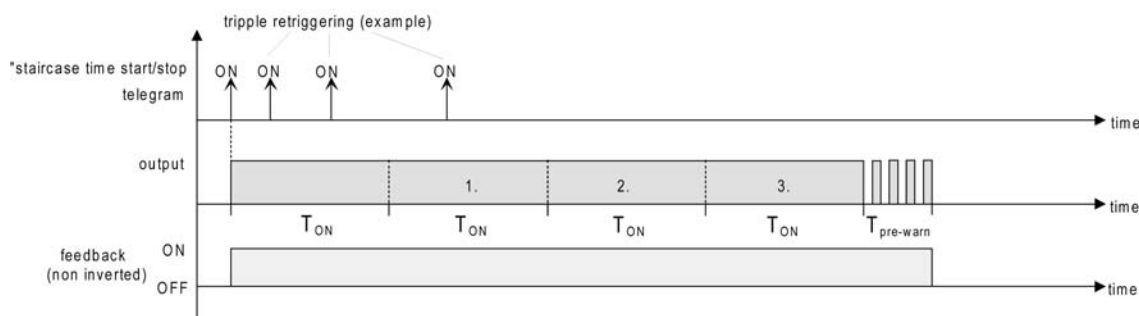

picture 21: Time extension for staircase function

With this function, the lighting time in a staircase can be extended (e.g. by a person after shopping) by a defined length without having to retrigger the lighting every time the lighting shuts off automatically.

The staircase function must be enabled on parameter page "Ax – Enabled functions" (x = number of switching output).

- Set the parameter "Supplementary function for staircase function" on parameter page "Ax – Staircase function" to "Time extension" and select the desired factor in the "Maximum time extension" parameter.

The staircase time is retriggered upon elapsing every time an ON telegram is received at the object "Staircase time start/stop" depending on the number of telegrams received, but only as often as specified by the parameterized factor.

For example, the setting "3-fold time" means that the started staircase time can be retriggered automatically at maximum three more times after elapsing. The time is thus at most quadrupled (see picture 21).

- i** Triggering of a time extension can take place during the entire staircase time (T_{EIN}). There is no time limitation between two telegrams for time extension. Telegrams for time extension are only evaluated during the staircase time. An ON telegram during the pre-warning function triggers the staircase time like a restart, so that a new time extension is also possible again.
If a switch-on delay has been parameterized, the time extension is recorded already during the switch-on delay.
- i** If a time extension has been parameterized as a supplementary function, the parameters "Staircase time retriggerable ?" and "Switch-on delay retriggerable ?" are fixed to "No" since retriggering is effected by the time extension.

Presetting the supplementary function of the staircase function "Time preset via the bus"

With time presetting via the bus, the parameterized staircase time can be multiplied with an 8-bit factor received from the bus and thus dynamically adapted. For this setting the factor is derived from the object "Staircase time factor". The possible factor value for setting the staircase time lies within the range between 1...255.

The overall staircase time is the product of the factor (object value) and the base (parameterized staircase time) as follows...

Staircase time = (staircase time object value) x (staircase time parameter)

Example:

Object value "Staircase time factor" = 5; parameter "Staircase time" = 10s.
-> preset staircase time = 5 x 10s = 50 s.

As an alternative, it is possible to define in the parameters of the staircase function whether the reception of a new factor starts at the same time also the staircase time of the staircase function. In this case, the "Staircase function start/stop" object does not apply, and starting and stopping is controlled by the factor value received.

The staircase function must be enabled on parameter page "Ax – Enabled functions" (x = number of switching output).

- Set the parameter "Supplementary function for staircase function" on parameter page "Ax – Staircase function" to "time preset via bus" and set the parameter "Staircase function activatable via 'Staircase time' object ?" to "No".

The staircase time can be adapted dynamically by means of the "Staircase time factor" object. A value of "0" is interpreted as a value of "1". Starting and stopping of the staircase function is effected exclusively via the "Staircase function start/stop" object.

- Set the parameter "Supplementary function for staircase function" on parameter page "Ax – Staircase function" to "time preset via bus" and set the parameter "Staircase function activatable via 'Staircase time' object ?" to "Yes".

The staircase time can be adapted dynamically by means of the "Staircase time factor" object. Additionally, the staircase function is started when a new factor with the new staircase time is received (the "Staircase function start/stop" object does not apply). A factor value "0" is interpreted like an OFF telegram; in this case the parameterized reaction to an OFF telegram is also evaluated.

A large staircase with several floors is a good example for a possible application of the 'time preset via the bus' function with automatic starting of the staircase lighting time. A push-button-sensor on each floor of the house transmits a factor value to the staircase function. The higher the floor, the greater the transmitted factor value in order to ensure that the lights remain on longer when it takes more time to reach the upper floors. When a person enters the staircase of the house and after pressing of a push-button sensor, the staircase lighting time is now dynamically adapted and the lighting switched on at the same time.

- i** The staircase function is started when a new factor is received: A factor > 0 received during a pre-warning time always retriggers the staircase time independent of the parameter "Staircase time retriggerable ?".
- i** After a reset (bus voltage return or ETS programming) the object "Staircase time factor" is always initialised with "1". However, this alone does not automatically start the staircase function (see "Presetting the behaviour of the staircase function after bus voltage return").
- i** The two supplementary functions "Time extension" and "Time preset via the bus" can now be parameterized as an alternative for one another.

Presetting the behaviour of the staircase function after bus voltage return

The staircase function can optionally be started automatically after bus voltage return.

The staircase function must be enabled on parameter page "Ax – Enabled functions" (x = number of switching output).

- Set the parameter "Behaviour after bus or mains voltage return" on the parameter page "Ax – General" to "Activate staircase function".

The staircase time of the staircase function is started immediately after bus or mains voltage return.

- i** In this setting it should be ensured that the staircase function is also enabled and configured. If the staircase function is not enabled, this setting will not show any reaction after bus/mains return.
- i** When the staircase function is started automatically after bus/mains voltage return, no switch-on delay is started, if the staircase function has parameterized such a delay.
- i** The device executes the parameterized "Behaviour after bus or mains voltage return" only if more than approx. 20 s have elapsed between the last ETS programming of the application or of the parameters and the time when the bus voltage is restored. Otherwise ($T_{ETS} < 20$ s) the "Behaviour after ETS programming" will be executed also in case of a bus voltage return.
If only the mains voltage fails after an ETS download and is then restored, the actuator executes the "Behaviour after bus or mains voltage return".
- i** The parameterized behaviour will only be adopted if no forced position is activated after bus voltage return.

- i** A switching state set after bus or mains voltage return will be tracked in the feedback object depending on the "Mode of operation" parameter.

Scene function

Up to 8 scenes can be created and scene values stored in the actuator separately for each switching output. The scene values are recalled or stored via a separate scene extension object by means of extension telegrams. The datapoint type of the extension object permits addressing a maximum of 64 scenes. Therefore the parameterization of a scene can be used to define the scene number (1...64) which is used to address the internal scene (1...8).

In order for the required communication objects and parameters (on parameter page "Ax – Scenes") to be visible, the scene function must have been enabled for each output on parameter page "Ax – Enabled functions".

The scene function can be combined with other functions of the output (see picture 22), in which case the command last received or set is executed:

A telegram to the object "Switching", a scene recall or a scene storage telegram at the time of an active staircase function terminates the staircase function prematurely and sets the switching state in accordance with the received object value (also taking time delays into account) or the scene value. Similarly, the switching state of the output that was set via the object "Switching" or a scene recall can be overridden by a staircase function or a new result of the logic function. A combination with the cyclical monitoring function is not possible.

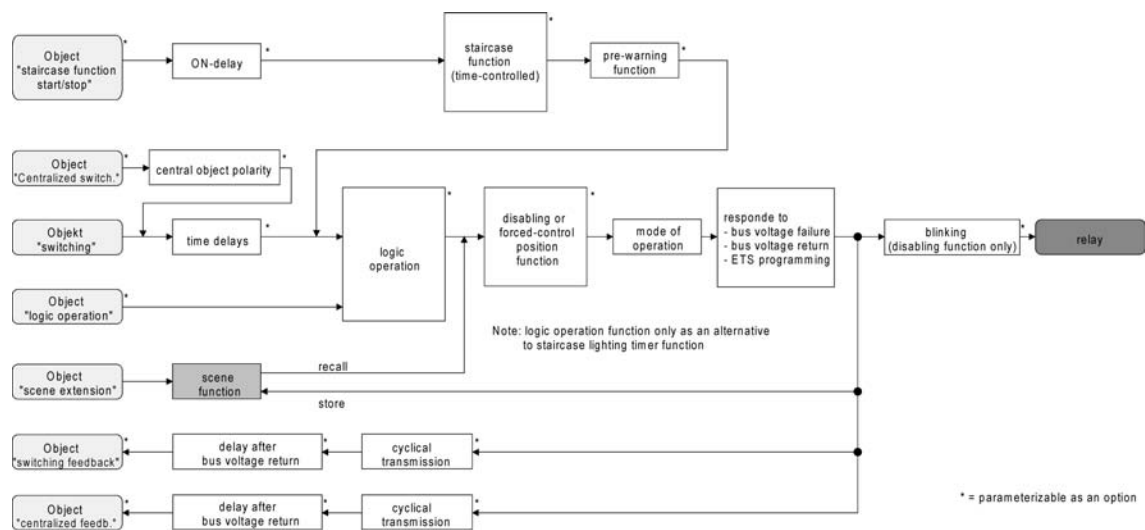

picture 22: Functional diagram of the scene function

Presetting a scene recall delay for the scene function

Each scene recall of an output can optionally also be delayed. With this feature, dynamical scene sequences can be configured if several outputs are combined with cyclical scene telegrams.

The scene function must be enabled on parameter page "Ax – Enabled functions" (x = number of switching output).

- Set the parameter "Delay scene recall?" on parameter page "Ax – Scenes" to "Yes"
 - The delay time is now activated and can be parameterized separately. The delay only influences the scene recall of the output. The delay time is started on arrival of a recall telegram. The corresponding scene will be recalled and the output set to the switching state only after this time has elapsed.
- i** Each scene recall telegram restarts the delay time and retriggers it. If a new scene recall telegram is received while a delay is active (scene recall not yet executed), the old (and not yet recalled scene) will be rejected and only the scene last received executed.

- i** The scene recall delay has no influence on the storage of scene values. A scene storage telegram within a scene recall delay terminates the delay and thus the scene recall.

Presetting the ETS download behaviour for the scene function

During storage of a scene, the scene values are stored permanently in the device (see "Presetting the storage behaviour for the scene function"). To prevent the stored values from being replaced during ETS programming of the application program or of the parameters by the originally programmed scene switching states, the actuator can inhibit overwriting of the scene values. As an alternative, the original values can be reloaded into the device during each programming run of the ETS.

The scene function must be enabled on parameter page "Ax – Enabled functions" (x = number of switching output).

- Set the parameter "Overwrite the values stored in the device during ETS download ?" on parameter page "Ax – Scenes" to "Yes".
During each ETS programming of the application or of the parameters, the scene values parameterized in the ETS for the output concerned will be programmed into the actuator. Scene values stored in the device by means of a storage function will be overwritten, if any.
 - Set the parameter "Overwrite the values stored in the device during ETS download ?" on parameter page "Ax – Scenes" to "No".
Scene values stored in the device with a storage function will be maintained. If no scene values have been stored, the switching commands last programmed in the ETS remain valid.
- i** When the actuator is put into operation for the first time, this parameter should be set to "yes" so that the output is initialised with valid scene values. Otherwise, the values in the actuator are "0" (off) for all scenes.

Presetting scene numbers and scene switching state for the scene function

The datapoint type of the scene extension object permits addressing of up to 64 scenes max. For this reason, the scene number (1...64) with which the scene is addressed, i.e. recalled or stored, must be determined for each internal scene (1...8) of the output. Moreover, the switching state to be set for the output in case of a scene recall must be specified as well.

The scene function must be enabled on parameter page "Ax – Enabled functions" (x = number of switching output).

- Set the parameter "Scene x activatable by scene number" (x = number of the scene (1...8)) on parameter page "Ax – Scenes" for each scene to the numbers with which the scenes are to be addressed.
A scene can be addressed with the parameterized scene number. A setting of "0" deactivates the corresponding scene so that neither recalling nor storage is possible.
- i** If the same scene number is parameterized for several scenes, only the scene with the lowest internal scene number (1...8) will be addressed. The other internal scenes will be ignored in this case.
- Set the parameter "Switching state in scene X" (x = number of the scene (1...8)) on parameter page "Ax – Scenes" for each scene to the desired switching command ("switch on" or "switch off").
In case of a scene recall, the parameterized switching command is recalled and the output is set correspondingly.
- i** The output is set to the switching command in a scene recall only if no forced position or disabling function is active.

- i** The parameterized switching command is adopted in the actuator during programming with the ETS only if the parameter "Overwrite values stored in the device during ETS download ?" is set to "Yes".

Presetting the storage behaviour for the scene function

The logic switching state ("switched on" or "switched off") set on the output in accordance with the function diagram can be stored internally via the extension object when a scene storage telegram is received. In this case the switching state before storage can be influenced by all functions of the output, if the individual functions are also enabled (e.g. also the disabling function, forced position function, manual control, etc.).

The following rule of thumb applies: The logical switching state that is stored is the one reported to the bus via the non-inverted feedback, or, if feedback is not enabled, the one that would have been reported back to the bus.

The scene function must be enabled on parameter page "Ax – Enabled functions" (x = number of switching output).

- Set the parameter "Storage function for scene x" (x = number of the scene (1...8)) on parameter page "Ax – Scenes" for each scene to "Yes".

The storage function is activated for the scene in question. On reception of a storage telegram via the "Scene extension" object, the current logical state will be internally stored.

- Set the parameter "Storage function for scene x" (x = number of the scene (1...8)) on parameter page "Ax – Scenes" for each scene to "No".

The storage function is deactivated for the scene in question. A storage telegram received via the "scene extension" object will be rejected.

Operating hours counter

The operating hours counter tracks the switch-on time of a switching output. For the operating hours counter an output is actively on when the relay contact is closed, i.e. when current is flowing to the load. This means that the counter always evaluates closed contacts independent of the selected mode of operation (NO or NC contact) and of the logical feedback of the switching status.

The operating hours counter takes the switch-on time for a connected relay contact, which is determined with accuracy to the minute, and adds it up to full hours (see picture 23). The added-up operating hours are tracked in a 2-byte counter and saved permanently in the device. The current count can be transmitted to the bus cyclically or after change by interval value via the communication object "Value operating hours counter".

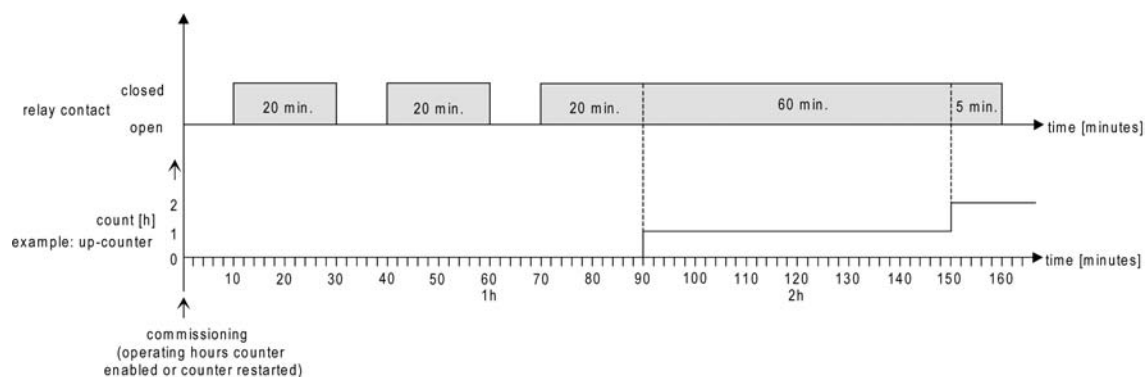

picture 23: Functional principle of the operating hours counter

In the state as supplied, all operating hours values of the actuator are "0" and no operating hours will be counted if the counter has not been enabled in the parameters of the output con-

cerned. If enabled, the operating hours counter begins counting and summing up the operating hours immediately after commissioning of the actuator.

If an operating hours counter is subsequently again disabled in the parameters and if the actuator is then programmed with this disable, all operating hours previously counted for the output concerned will be deleted. After re-enabling, the operating hours counter always begins with "0".

The operating hours values (full hours) stored in the device are not lost in case of a bus voltage failure or ETS programming. Added-up operating minutes (which have not reached a full hour) are lost in this case, however.

After bus voltage return or an ETS download the actuator passively updates the communication object "Value operating hours counter" for each output. The object value can be read out if the Read flag is set. Depending on the parameterization for automatic transmitting, the object value will if necessary be transmitted actively to the bus as soon as the parameterized transmit delay after bus voltage return has elapsed (see "Presetting the transmit behaviour of the operating hours counter").

Operating hours will only be counted if the mains voltage is switched on.

Activating the operating hours counter

- Set the parameter "Operating hours counter" on parameter page "Ax – Enabled functions" to "Enabled".

The operating hours counter is activated.

Deactivating the operating hours counter

- Set the parameter "Operating hours counter" on parameter page "Ax – Enabled functions" to "Disabled".

The operating hours counter is deactivated.

- i** Disabling of the operating hours counter and subsequent programming with the ETS causes the counter to be reset to "0".

Presetting the type of counter of the operating hours counter

The operating hours counter can be configured as an up-counter or a down-counter. Depending on the above mode, the counter permits presetting a limit or start value which can be used, for instance, to monitor the hours in operation of a lamp by restricting the counting range.

Up-counter:

After activation of the operating hours counter via enabling in the ETS or a restart, the operating hours are counted starting at "0". A maximum of 65535 hours can be counted, after which the counter stops and reports "counter elapsed" via the object "Operating hours counter elapsed". As an option, a limit value can be set in the ETS or specified via the communication object "Operating hours limit value". In this case the "counter elapsed" is already reported to the bus via the object "Operating hours counter elapsed" when the limit value is reached, but unless the counter is restarted it will continue to run up to the maximum value of 65535 hours and stop then. Only a restart will initiate a new counting process.

Down-counter:

When the operating hours counter is enabled in the ETS the count is at "0" and after programming or bus voltage return the actuator reports "counter elapsed" for the outputs concerned via the object "Operating counter elapsed". Only after a restart will the down-counter be set to the maximum value 65535 and the counting process will be started.

As an option, the start value can be set in the ETS or specified via the communication object "Op. hours counter start value". If a start value is set, the down-counter is initialised after a restart with this value instead of the maximum value. The counter then counts the start value

downwards hour by hour. When the down-counter reaches the value "0", "counter elapsed" is reported to the bus via the object "Operating hours counter elapsed", and the counting process is stopped. Only a restart will initiate a new counting process.

The operating hours counter must be enabled on parameter page "Ax – Enabled functions" (x = number of switching output).

- Set the parameter "Type of counter" on parameter page "Ax – Operating hours counter" to "Up-counter". Set the parameter "Limit value preset ?" to "yes, as specified in parameter" or "yes, as received via object", if limit value monitoring is necessary. Otherwise set the parameter to "no". "yes, as specified in parameter" setting: parameterize the necessary limit value (0...65535 h).

The counter increments the operating hours beginning with "0". If the limit value monitoring function is active, the actuator sends a "1" telegram for the output concerned via the "Operating hours counter elapsed" object as soon as the preset limit value is reached. Otherwise, "counter elapsed" will be transmitted only after reaching the max. value of 65535.

- Set the parameter "Type of counter" on parameter page "Ax – Operating hours counter" to "down-counter". Set the parameter "Start value preset ?" to "yes, as specified in parameter" or "yes, as received via object", if a start value preset is necessary. Otherwise set the parameter to "no". "yes, as specified in parameter" setting: parameterize the necessary start value (0...65535 h).

After a restart, the counter decrements the operating hours until "0" is reached. If the start value preset mode is active, the counter counts down from the start value. Otherwise, counting begins from the max. value 65535. The actuator sends a "1" telegram for the output concerned via the object "Operating hours counter elapsed" as soon as "0" is reached.

- i** The value of the communication object "Operating hours counter elapsed" is stored permanently internally. After the supply voltage is switched on or after ETS programming, the object is initialised with the previously saved value. If in this case an operating hours counter is designated as elapsed, i.e. the object value is "1", then in addition a telegram is transmitted actively to the bus as soon as the parameterized transmit delay after bus voltage return has elapsed. If the counter has not elapsed yet (object value "0"), then no telegram is transmitted after bus voltage return or after ETS programming.
- i** In case of limit value or start value presetting via communication object: The values received via the object only adopted as valid and stored permanently when the operating hours counter is restarted. After the supply voltage is switched on or after ETS programming, the object is initialised with the last saved value. The received values will be lost during a bus voltage failure or an ETS download if no counter restart is carried out before the failure or download. For this reason it is recommended always to carry out a counter restart after specifying a new start value or limit value.
As long as no limit or start value has been received via the object, a fixed default value of 65535 is preset. The values received and saved via the object are reset to the default value if the operating hours counter is disabled in the parameters of the ETS and an ETS download is carried out.
- i** In case of limit or start value preset: If the start or limit value was preset with "0", a distinction is made among the following cases...
In case of presetting as parameterized: The counter elapses immediately after enabling of the operating hours counter with download in the ETS or after a counter restart.
In case of presetting via object: A counter restart is ignored in order to prevent an unintentional reset (e.g. in building site operation -> due to manual control, operating hours have already been counted).
- i** If the counting direction of an operating hours counter is reversed by a parameter change in the ETS, the counter should always be restarted after programming of the actuator to ensure its re-initialisation.

Restarting the operating hours counter

The operating hours count can be reset at any time by the "Restart operating hours counter" communication object. The polarity of the restart telegram object is fixed. "1" = restart / "0" = no reaction.

With the up-counter the counter is initialised with the value "0", and with the down-counter it is initialised with the start value. If no start value has been parameterized or specified via the object, a fixed start value of 65535 is preset.

During each restart of the counter, the initialised count will be transmitted actively to the bus. In case of a restart the "counter elapsed" report is also reset. This done by transmitting a "0" telegram to the bus via the "Operating hours counter elapsed" object. In addition, the limit or start value is initialised.

- i** If a new limit or start value has been preset via the communication object, the counter should always be restarted thereafter. Otherwise, the received values will be lost during a bus voltage failure or an ETS download.
- i** If a start or limit value with "0" is preset, then in case of a reset there are various behaviour patterns depending on the principle of the preset value...
In case of presetting as parameterized:
The counter elapses immediately after a counter restart.
In case of presetting via object:
A counter restart is ignored in order to prevent an unintentional reset (for example after installation of the devices, during which operating hours were already counted due to the manual control). In order to execute the restart, a limit or start value greater than "0" must first be specified.

Presetting the transmit behaviour of the operating hours counter

The current value of the operating hours counter is always tracked in the communication object "Value operating hours counter". After bus voltage return or an ETS download the actuator passively updates the communication object "Value operating hours counter" for each output. The object value can be read out if the Read flag is set.

In addition, the transmit behaviour of this communication object can be preset.

The operating hours counter must be enabled on parameter page "Ax – Enabled functions" (x = number of switching output).

- Set the parameter "Automatic transmitting of the counter value" on parameter page "Ax Operating hours counter" to "after change by interval value". Set the parameter "Count value interval (1...65535)" to the desired value.

The count is transmitted to the bus as soon as it changes by the preset count value interval. After bus voltage return or after ETS programming, the object value will be automatically transmitted after the "Delay after bus voltage return" has elapsed, when the current count corresponds to the count value interval or a multiple thereof. A count of "0" will in this case always be transmitted.

- Set the parameter "Automatic transmitting of the counter value" on parameter page "Ax Operating hours counter" to "cyclical".

The counter value is transmitted cyclically. The cycle time is defined independent of the channel on the parameter page "General switching outputs". After bus voltage return or ETS programming, the count is transmitted to the bus for the first time when the parameterized cycle time elapses.

Supplementary functions

Supplementary functions can be enabled for each switching output. A disabling function or alternatively a forced position function can be configured as the supplementary function. Thus only one of these functions can be enabled for an output. It is also possible to parameterize a logic operation function.

These supplementary functions can be enabled and parameterized on parameter page "Ax – Enabled functions" (x = number of switching output).

Presetting the disabling function as a supplementary function

The disabling function can also be combined with other functions of the output in accordance with the function diagram (see picture 24). In case of an active disabling function the upstream functions are overridden, so that the output concerned is locked in the disabling position. The override can also be used to implement a continuous-light circuit.

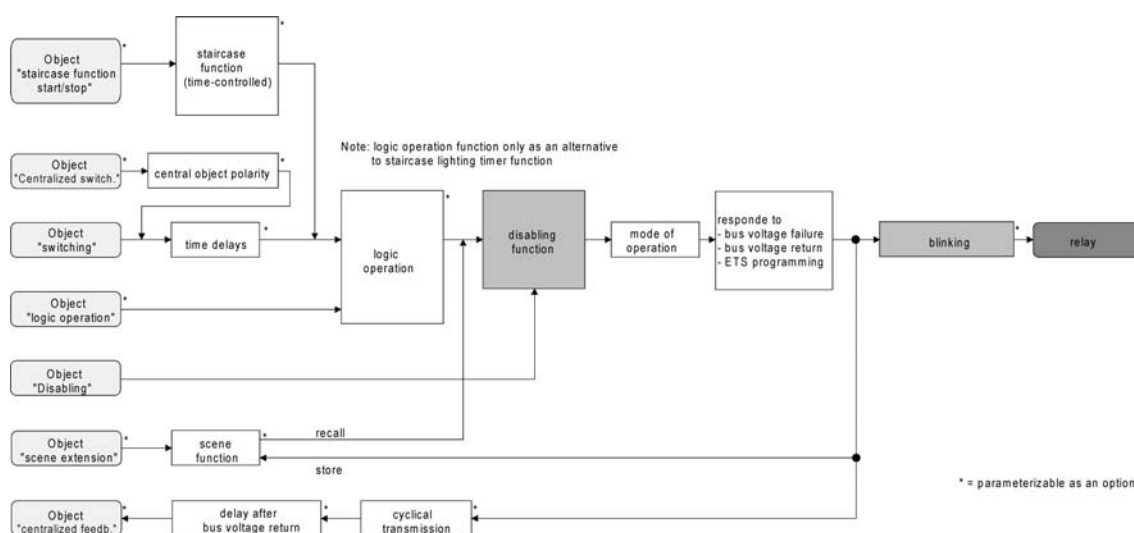

picture 24: Functional diagram of the disabling function

- Set the parameter "Selection of supplementary function" on parameter page "Ax – Supplementary functions" to "Disabling function".
The disabling function is enabled. The "Disabling" communication object and the parameters of the disabling function are visible.
- Set the parameter "Polarity of the disabling object" on parameter page "Ax – Supplementary functions" to the desired polarity.
- i After a bus or mains voltage failure or after ETS programming of the application or parameters the disabling function is always deactivated (object value "0"). In the inverted setting ("1 = enabled; 0 = disabled"), after initialisation a telegram update "0" has to take place before the disabling function is activated.
- i Updates of the disabling object from "ON" to "ON" or from "OFF" to "OFF" show no reaction. The relay remains in the position last set, if applicable also set manually.
- i An output disabled via the bus can still be operated by hand!

- Set the parameter "Behaviour at the beginning of the disabling function" on parameter page "Ax – Supplementary functions" to the desired behaviour.
At the beginning of disabling, the parameterized behaviour will be executed and the output locked. When the setting "No change of switching state" is selected, the relay of the output shows no reaction and remains in the switching state last set (state according to the last non-inverted feedback). In the "flashing" setting the output is switched on and off cyclically during the disabling function. The flashing time is parameterized generally for all outputs on the parameter page "General". During the flashing the logical switching state is "ON 1".
- Set the parameter "Behaviour at the end of the disabling function" on parameter page "Ax – Supplementary functions" to the desired behaviour.

At the end of disabling, the parameterized behaviour will be executed and the output re-enabled. When the setting "No change of switching state" is selected, the relay of the output shows no reaction and remains in the state last set by the disabling function.

With "setting tracked state", the last switching state active before the disabling function or the switching state tracked internally during the disabling function is set at the end of disabling. Residual times of time functions or of the staircase function are tracked, if they have not completely elapsed when the disabling function is terminated. With the settings "no change of switching state", "switch on", "switch off" or "flashing" the states set at the end of the disabling function have no effect on time or staircase functions.

In the "flashing" setting the output is switched on and off cyclically after the disabling function. The flashing continues until a new switching state is specified. The flashing time is parameterized generally for all outputs for all outputs on the parameter page "General". During the flashing the logical switching state is "ON 1".

- i** The states defined for the end of the disabling function override a logic function if parameterized. The parameterized logic operation will be executed and the result forced on the output only if at least one input state of the logic operation changes or is updated after the disabling function has been terminated.

Presetting the forced position function as a supplementary function

The forced position function can also be combined with other functions of the output in accordance with the function diagram (see picture 25). In case of an active forced position function the upstream functions are overridden, so that the output concerned is locked in the forced position.

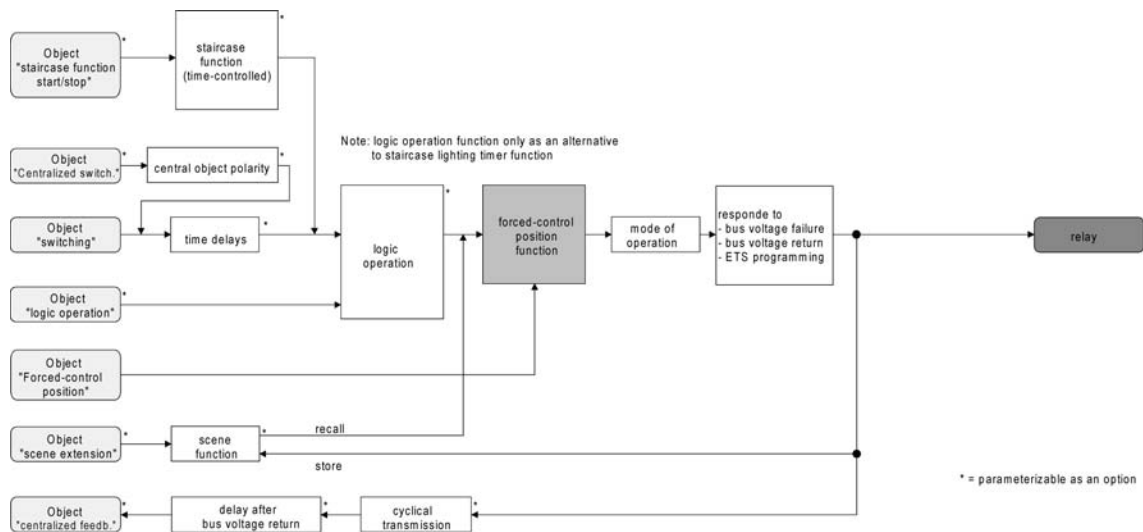

picture 25: Functional diagram of the forced position function

- Set the parameter "Selection of supplementary function" on parameter page "Ax – Supplementary functions" to "Forced position".

The forced position function is enabled. The "forced position" communication object and the parameters of the forced position function are visible.

Bit 1	Bit 0	Function
0	x	forced position not active normal control
0	x	forced position not active normal control
1	0	forced position active: switch off
1	1	forced position active: switch on

Bit coding of forced position

- i** Updates of the forced position object from "forced position ON" to "forced position ON" will cause the relay every time to switch the contact into the forced position. Updates from "forced position OFF" to "forced position OFF" remain without effect.
- i** An output under forced control from the bus can still be operated by hand!

- Set the parameter "Behaviour at the end of the forced position function" on parameter page "Ax – Supplementary functions" to the desired behaviour.

At the end of the forced position function, the parameterized behaviour will be executed and the output re-enabled for normal control. When the setting "No change of switching state" is selected, the relay of the output shows no reaction and remains in the state last set by the forced position function.

With "tracking the switching state", the last switching state active before the forced position function or the switching state tracked internally during the forced position function is set at the end of the forced position function. Residual times of time functions or of the staircase function are tracked, if they have not completely elapsed when the forced position function is terminated. With the settings "no change of switching state", "switch on", "switch off" or "flashing" the states set at the end of the forced position function have no effect on time or staircase functions.
- i** The states defined for the end of the forced position function override a logic function if so parameterized. The parameterized logic operation will be executed and the result forced on the output only if at least one input state of the logic operation changes or is updated after the forced control function is terminated.

The communication object of the forced position function can be initialised after bus voltage return. In this way, the switching state of the output can be influenced when the forced position function is activated.

- Set the parameter "Behaviour after bus voltage return" on parameter page "Ax – Supplementary functions" to the desired behaviour.

After bus voltage return the parameterized state is adopted in the communication object "Forced position". If a forced position function is active, then immediately after bus voltage return the output is switched to the appropriate position and interlocked by forced control until the forced control function is terminated via the bus. In this case the parameter "Behaviour after bus or mains voltage return" on the parameter page "Ax – General" will not be evaluated for the output concerned.

With the setting "State of the forced position before bus voltage failure" the state of the forced position is preset in the way that is was stored permanently at the point in time of a bus or mains failure. After programming of the application or of the parameters with the ETS, in this case the value is always set internally to "not active".
- i** A failure of the mains voltage of the actuator always deactivates a forced position. The forced position is not activated even if no mains voltage is present when the bus voltage returns. In this case when the mains voltage returns the parameter "Behaviour after bus or mains voltage return" on the parameter page "Ax – General" will be executed.
- i** The forced position function is always deactivated (object value "0") after ETS programming of the application or the parameters.
- i** The device executes the parameterized "Behaviour after bus voltage return" of the forced position function only if more than approx. 20 s have elapsed between the last ETS programming of the application or of the parameters and the time when the bus voltage is restored. Otherwise ($T_{ETS} < 20$ s) the forced position will not be activated and the "Behaviour after ETS programming" will not be executed in case of a bus voltage return.

Presetting the logic function as a supplementary function

A logic function can be parameterized separately and independently for each output. This function permits linking the state of the "Switching" object with an additional logic operation object. The state of the communication object for "Switching" can also be evaluated with a delay when a switch-on or switch off delay is defined.

The logic operation function can also be combined with other functions of the output in accordance with the function diagram (see picture 26). Combination with the staircase function or cyclical monitoring is not possible, however.

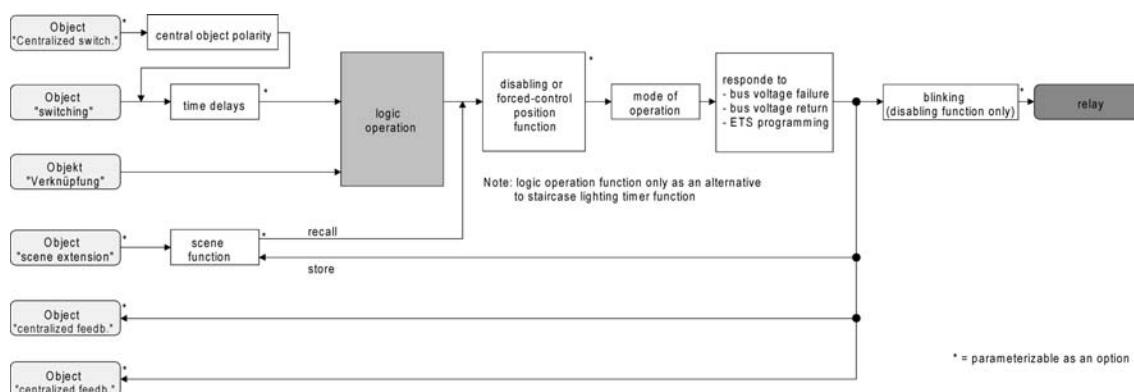

picture 26: Functional diagram of the logic function

The following gating operations can be parameterized (see picture 27).

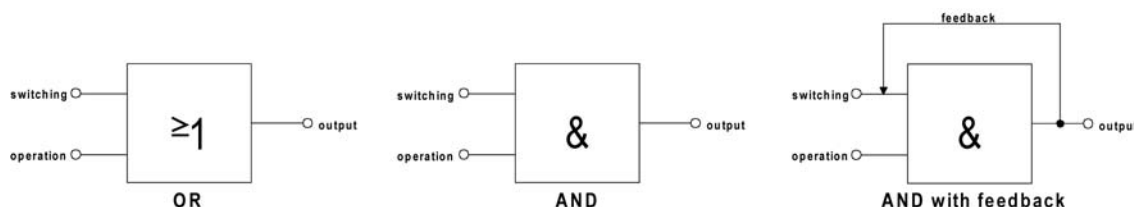

picture 27: Gating operations of the logic function

i "AND with feedback":

For a logic operation object = "0" the output is always "0" (logical AND). In this case the feedback of the output to the "Switching" input resets it during setting. Only if the logic operation object = "1" can a newly received "1" at the "Switching" input assume the logical state "1".

After bus voltage return or after ETS programming, the "Logic operation" object can be initialised with a pre-parameterized value, so that in case of a telegram update to the "Switching" object a correct logic operation result can immediately be determined and set on the output.

- Set the parameter "Logic operation function ?" on parameter page "Ax – Supplementary functions" to "Yes".
The logic function is enabled. The "Logic operation" communication object and the parameters of the logic function are visible.
- Set the parameter "Type of logic operation" on parameter page "Ax – Supplementary functions" to the desired type of logic operation.
- Set the parameter "Value of logic operation object after bus voltage return" and "Value of logic operation object after ETS download" on parameter page "Ax – Supplementary functions" to the desired initial conditions.

After bus voltage return or after ETS programming of the application software or of the parameters, the "Logic operation" object is initialised with the preset switching states.

- i** After an actuator reset (bus voltage return or ETS programming), the logic function will be executed only if at least one input object of the logic operation is updated by means of a telegram from the bus.
- i** The states specified at the end of a disabling or forced position function or the switching states that are preset after ETS programming, bus voltage failure or after bus/mains voltage return, override the logic operation function. The parameterized logic operation will be executed and the result forced on the output only if at least one input state of the logic operation changes or is updated.
- i** Mains voltage return does not affect the communication objects of the logic operations. The objects remain in the state last set, if the bus voltage was connected without interruptions.

Cyclical monitoring

The actuator offers the possibility of monitoring individual or all output channels cyclically for the arrival of switching telegrams. In this manner the objects that have to be updated cyclically by the bus can be monitored. The polarity of the telegram updating ("0" or "1") has no meaning here.

If no update of the monitored objects is received within a fixed parameterized monitoring time, the outputs concerned set themselves to a predefined preferred position. However, this does not disable the outputs, so that when an additional switching telegram is received the new switching state is also set on the output.

The monitoring time is defined globally for all outputs on the parameter page "General switching outputs" via the parameter "Time for cyclical monitoring". However, each output has its own time control functions, so that the parameterized monitoring time is evaluated independent of the channel.

The time is restarted for an output every time a switching telegram is received via the objects "Switching" or "Central switching" (if a central function is activated for the output concerned (see picture 28)). A restart of the monitoring time also takes place automatically after bus voltage return or after programming with the ETS.

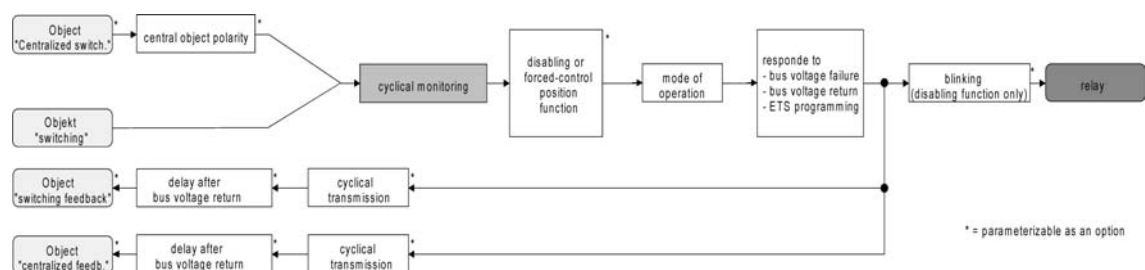

picture 28: Functional diagram of the cyclical monitoring function

Activating the cyclical monitoring function

The cyclical monitoring can be activated separated for each output via the parameter "Assignment to cyclical monitoring ?" on the parameter page "Ax – Enabling functions" (x = number of the switching output). When the function is activated, as soon as the monitoring time elapses without a telegram update having been received, the actuator sets the output concerned to the preferred position after the time has elapsed.

- Set the parameter to "Yes, "ON" when time has elapsed".
The cyclical monitoring function is now activated. The output will be switched on when the time has elapsed.
- Set the parameter to "Yes, "OFF" when time has elapsed".
The cyclical monitoring function is now activated. The output will be switched off when the time has elapsed.
- i** When the cyclical monitoring function is active, the following functions cannot be parameterized: time delays, staircase function, logic operation and scene.

- i If an output is already in its preferred state when the monitoring time elapses, there will be no reaction and no transmission of a feedback telegram.
- i The disabling or forced position function has a higher priority than the cyclical monitoring function.

4.2.4.2.2 Functional description for blind outputs

Mode of operation

Each output of the room actuator can be independently configured for the drive type connected by defining the mode of operation. The actuator permits controlling slatted blinds, shutters, awnings and also venting louvers. Depending on the preset mode of operation, the ETS adapts the parameters and communication objects for all functions of an output.

This means, for instance, that the "blind" mode of operation also has parameters and objects for the slat control. In the "shutter / awning" mode there is no slat control, but a fabric-stretching function parameter instead when awnings are used. In the "venting louver" mode a distinction is made between "closing" and "opening" movements instead of upward or downward travels as in case of blinds or shutters.

In this documentation, blinds, shutters or awnings are also designated with the term "curtain", if the text does not explicitly refer to a particular function (e.g. slat control).

In all modes it is possible to specify positions.

Presetting the mode of operation

The parameter "Mode of operation" exists separately for each blind output on the parameter pages "Ax General" (x = number pair of the output).

- Select the required mode of operation in the "Mode of operation" parameter.
- i** The "Mode of operation" parameter has an influence on many channel-oriented parameters and communication objects. When the mode of operation is changed in the ETS, the parameters are adapted dynamically so that settings already made or links between group addresses can be reset. For this reason, the required mode of operation should be parameterized at the beginning of the channel-oriented device configuration.
- i** Venting louvers must be connected to the outputs in such a way that they are opened in travel direction "up - ▲" and closed in travel direction "down - ▼".
- i** An awning travels upwards when it is rolled up.

Behaviour in case of bus voltage failure, after bus or mains voltage return or after programming with the ETS

The preferred relay contact positions after bus voltage return or after ETS programming can be preset separately for each output. Since the actuator is equipped with mains-dependent monostable relays, the relay switching state at bus voltage failure can be defined as well.

Presetting the behaviour after ETS programming

The parameter "Behaviour after ETS programming" can be preset separately for each output channel on the parameter page "Ax - General" (x = number pair of the output). This parameter can be used to parameterize the relay behaviour of the output independently of the behaviour after bus or mains voltage return.

Depending on the selected mode of operation, the ETS adapts the designations of the parameter settings ("raising" ↔ "opening the louver" / "lowering" ↔ "closing the louver").

- Set the parameter to "stop".
After programming with the ETS, the actuator switches the relays of the output to the "stop" position. A travel movement, if any, will be interrupted.
- Set the parameter to "raising" or "opening the louver".
After programming with the ETS, the actuator raises the curtain or opens the venting louver.
- Set the parameter to "lowering" or "closing the louver".
After programming with the ETS, the actuator lowers the curtain or closes the venting louver.

- i** At the beginning of each ETS programming cycle, the room actuator always executes a "stop" command for all outputs. The manual mode, if active, will be terminated.
- i** The "Behaviour after ETS programming" as parameterized will be executed after every ETS application or parameter download. A simple download of the physical address alone or partial programming of only the group addresses has the effect that this parameter is disregarded and that the parameterized "Behaviour after bus or mains voltage return" will be executed instead.
- i** ETS programming can be performed as soon as the bus voltage is connected to the room actuator and switched on. The mains voltage supply is not required for an ETS download. If programming with the ETS was performed with bus voltage only, the parameterized "Behaviour after ETS programming" will only be executed when also the mains voltage supply of the actuator has been switched on. The "Behaviour after bus or mains voltage return" will not be activated in this case!
This reaction must be taken into account especially with actuators that are installed in pre-programmed condition into an existing electrical installation.
- i** After programming with the ETS, the safety functions, the forced positions and the sun protection function are always deactivated.

Presetting the behaviour in case of bus voltage failure

The parameter "Behaviour in case of bus voltage failure" can be preset separately for each output channel on the parameter page "Ax - General" (x = number pair of the output). The parameter defines the behaviour of a shutter output if only the bus voltage fails. The parameterized behaviour will not be executed if a manual control mode is active at the time of bus failure (status LEDs flash in case of temporary or permanent manual control).

Depending on the selected mode of operation, the ETS adapts the designations of the parameter settings ("raising" ↔ "opening the louver" / "lowering" ↔ "closing the louver").

- Set the parameter to "stop".
In case of bus voltage failure, the actuator switches the relays of the output to the "stop" position. A travel movement, if any, will be interrupted.
- Set the parameter to "raising" or "opening the louver".
After bus voltage failure, the actuator raises the curtain or opens the venting louver.
- Set the parameter to "lowering" or "closing the louver".
After bus voltage failure, the actuator lowers the curtain or closes the venting louver.
- Set the parameter to "approach position".
In case of bus voltage failure, the connected drive can approach a position specified by further parameters (0...100 %). If blinds are controlled with the device, the slats can be positioned independently. The actuator performs a reference travel before the position approach, if the current position at the time of bus failure is unknown (e.g. due to power supply failure or to previous ETS programming).
- Set the parameter to "no reaction".
In the event of bus voltage failure, the relay of the output shows no reaction. Motions still in progress at the time of failure will still be completed as long as the mains voltage supply is still on.
- i** Safety, forced position or sun protection functions (independent of the selected priority) remain active even after a bus voltage failure as long as the mains voltage supply is still on. These functions will therefore be executed again at the end of a temporary or permanent manual control (if enabled in case of bus failure) even if there is no bus voltage.
- i** When the still ongoing motion or the motion parameterized in case of bus voltage failure has come to an end, the outputs can no longer be activated except by manual control (if the mains voltage is on and if manual control is enabled) or by bus/mains voltage return.
- i** A bus voltage failure will in any case result in a stop of all time functions. Thus, all scene recalls in the delay phase will be aborted and all delay times for sun protection and presence will be ended by ignoring the object value last received and still in the delay phase. A telegram update received shortly before bus voltage failure is then lost, if the corresponding delay has not yet elapsed.

- i** In the event of a mains voltage failure, all relays of the actuator will always drop out ("stop") independent of the bus voltage condition. In this state the outputs can no longer be activated. Time functions (scene, sun protection and presence delays) are not interrupted, if only the mains voltage fails.
- i** In case of bus or mains voltage failure, the current position data of the outputs are permanently stored in the device so that the corresponding positions can be precisely tracked after bus or mains voltage return, if so parameterized. The data are stored before the reaction parameterized for the case of bus voltage failure takes place and only if one part of the supply (mains or bus) is still present, or if the supply fails completely after the mains voltage has been available before without interruption for at least 20 seconds after the last reset (storage capacitors sufficiently charged for storage purposes). The data will not be stored, if the position data are unknown. The saving process is performed only once after the failure of one part of the supply voltage...

Example 1:

Bus voltage failure -> saving process -> then mains voltage failure -> no additional saving process,

Example 2:

Mains voltage failure -> saving process -> then bus voltage failure -> no additional saving process,

The following rules apply for the position data to be stored:

The current curtain, slat and louver positions are stored. With blinds, the height to be stored is always referred to a slat position of 100 % (cf. "Calculating the slat position"). Positions temporarily approached will be stored also for those outputs that are involved in a travel movement at the time of data storage. On account of the fact that position data are stored as integer percentage values (0...100), a minor deviation from the positions reported back later during bus or mains voltage return (number range 0..255) cannot be avoided.

As the position values are stored only once during bus voltage failure, positions that are changed by manual control after bus voltage failure cannot be tracked. Similarly, forced position telegrams received via the bus after a mains voltage failure or slat offset positions for the sun protection function cannot be stored and tracked either.

The stored position data are not lost in case of ETS programming.

- i** In case of bus or mains voltage failure, the current states of the forced position control or – if parameterized – also the slat offsets of the sun protection positions are stored as well.

Presetting the behaviour after bus or mains voltage return

The parameter "Behaviour after bus or mains voltage return" can be preset separately for each output channel on the parameter page "Ax – General" (x = number pair of the switching output). Depending on the selected mode of operation, the ETS adapts the designations of the parameter settings ("raising" ↔ "opening the louver" / "lowering" ↔ "closing the louver").

- Set the parameter to "stop".
In case of bus or mains voltage return, the actuator switches the relays of the output to the "stop" position. A travel movement, if any, will be interrupted.
- Set the parameter to "raising" or "opening the louver".
After bus or mains voltage return, the actuator raises the curtain or opens the venting louver.
- Set the parameter to "lowering" or "closing the louver".
After bus or mains voltage return, the actuator lowers the curtain or closes the venting louver.
- Set the parameter to "position in case of bus / mains failure".

After bus or mains voltage return, the position value (including the slat position in the case of blinds) last selected and stored internally before bus or mains voltage failure will be tracked. The actuator performs a reference travel before the position approach, if the current position at the time of bus or mains voltage return is unknown (e.g. due to complete power supply failure or to previous ETS programming).

- Set the parameter to "approach position".
In case of bus or mains voltage return, the connected drive can approach a position specified by further parameters (0...100 %). If blinds are controlled with the device, the slats can be positioned independently. The actuator performs a reference travel before the position approach, if the current position at the time of bus or mains voltage return is unknown (e.g. due to complete power supply failure or to previous ETS programming).
- i** "Position in case of bus / mains failure" setting: If no position values could be stored in case of bus or mains voltage failure because the position data were unknown (no reference travel executed), the actuator shows no reaction with this parameterization either.
- i** All time functions (scene, sun and presence delay) are only stopped in case of bus voltage failure so that a mains voltage failure does not result in a loss of states or time functions as long as the bus voltage is present.
- i** The parameterized behaviour is always executed independent of the current states of the safety or sun protection function. Safety and sun protection function can nonetheless be active even after bus or mains voltage return, if these functions have been activated before a bus voltage failure or before or during a mains voltage failure. In this manner it is possible to override direct operation.
Only in case of a complete supply failure (bus voltage and mains voltage) are the sun protection or the safety functions deactivated.
- i** The communication object of the forced position function can be initialised separately after bus voltage return. This has an effect on the reaction of the output when the forced position is activated. A mains failure alone has no effect on the forced position. In case of a return of only the mains voltage, a previously activated forced position remains active.
The parameterized "Behaviour in case of bus or mains voltage return" will only be executed if no forced position is activated after bus voltage return.
- i** An active manual control is terminated on return of bus voltage. In case of mains failure, no manual control is possible.
- i** The device executes the parameterized "Behaviour after bus or mains voltage return" only if more than ca. 20 s have elapsed between the last ETS programming of the application or of the parameters and the time when bus and mains voltage are restored. Otherwise ($T_{ETS} < 20$ s) the "Behaviour after ETS programming" will be executed also in case of bus/mains voltage return.
If only the bus or the mains voltage fails after an ETS download and is then restored, the actuator executes the "Behaviour after bus or mains voltage return".

Determining and configuring STEP and MOVE operation

The short-time operation (STEP) permits adjusting the slat tilting angle of a blind or the 'slit opening width' of a shutter. In most cases, STEP operation is activated by pressing a blind pushbutton sensor permitting manual intervention in the curtain control cycle. When the actuator receives a STEP command while the blind, shutter, awning or louver is in motion, the travel movement is stopped immediately by the actuator.

Long-time operation(Move) is determined by the travelling time of the connected blind, shutter/awning or louver and must therefore not be preset separately. The travelling time must be measured 'manually' and the parameters entered in the ETS. The control of an output by means of a MOVE or STEP telegram is also designated as 'direct operation'.

To ensure that the curtain or the louver has definitely reached its end position at the end of MOVE operation, the actuator always prolongs the MOVE travel movement by 20% of the parameterized or taught travelling time.

The parameterized travelling time extension will moreover be taken into account by the actuator for all upward travels or all travel movements into the open position as the drive motors are then generally no so fast due to the weight of the curtain or to external physical influences (e.g. temperature, wind, etc.). Thus, it is ensured that the upper end position is always reached even in case of uninterrupted MOVE operations.

- i** A MOVE or STEP operation can be retriggered by a new incoming MOVE or STEP telegram.
- i** A travel movement activated in the manual control mode or by a safety function is always a MOVE operation. The "raising" or "lowering" commands parameterized in the ETS will likewise activate the MOVE operation.

Presetting the STEP operation

The STEP operation is parameterized separately for each output and independent of the travelling time of the curtain or of the louver. The project designer can specify in the ETS whether the output executes only a "stop" for a travel movement on reception of a STEP telegram or whether the output is activated for a specific duration.

- Set the parameter "STEP operation" on parameter page "Ax - Times" (x = number pair of the output) to "Yes".
The actuator activates the output concerned for the time specified under "Time for STEP operation" when a STEP telegram is received and when the output is not in the process of executing a travel movement. If the output is executing a travel movement at the time of telegram reception, the output will just stop.
- Set the parameter "STEP operation" on parameter page "Ax - Times" (x = number pair of the output) to "No (only stop)".
The actuator will only stop the output on reception of a STEP telegram if the output is in the process of executing a travel movement. There will be no reaction if the output is not executing a travel movement at the time of telegram reception.
- i** The parameterized "Time for STEP operation" should correspond for a blind to ca. $\frac{1}{4}$ of the complete slat moving time and for a shutter to the full time needed for opening the shutter segments.
- i** The STEP operation is always executed without travelling time extension.

Determining and configuring travelling times

For computing positions and also for executing MOVE operation, the actuator needs the exact travelling time of the connected blind, shutter/awning or louver. Without using the automatic end position detection, the travelling time for a shutter output must be measured 'manually' and entered as a parameter into the ETS. It is important to determine the travelling time accurately to permit positions to be approached with good precision. Therefore, it is recommended to make several time measurements and to take the average of these values before entering them into the corresponding parameter. The travelling time corresponds to the duration of a travel movement from the completely open position (upper end position / awning rolled up) to the completely closed position (lower end position / awning completely unrolled) and not vice versa! The travelling times are to be determined as a function of the different types of movements.

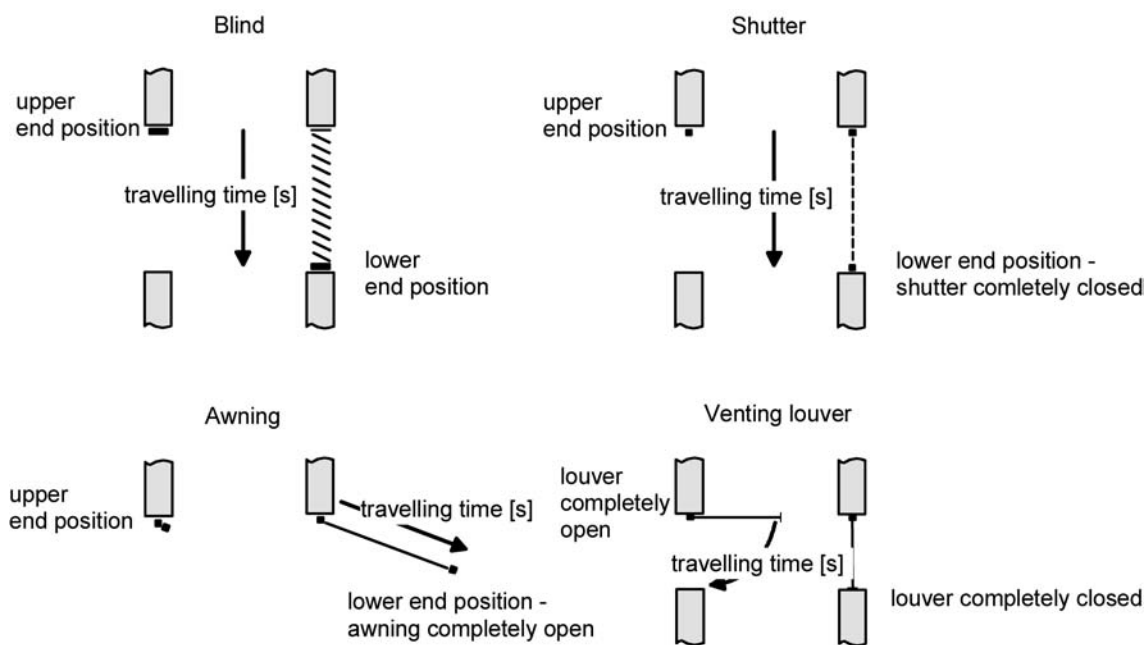

picture 29: Travelling time as a function of the type of movement

Travelling time of blinds, shutters, awnings and louvers

The measurement of the travelling time is described in detail in chapter "Commissioning".

The automatic end position detection must be deactivated.

- Enter the exact travelling times determined in the course of the commissioning procedure into the parameters "Blind travelling time" or "Shutter/awning travelling time" or "Venting louver travelling time" on parameter page "A1 – Times" (x = number pair of the output). The maximum travelling time is '59 minutes 59 seconds. The working principle does not allow longer travelling times.

i The parameterized travelling time extension will moreover be taken into account by the actuator for all upward travels or all travel movements into the open position as the drive motors are then generally no so fast due to the weight of the curtain or to external physical influences (e.g. temperature, wind, etc.).

Determining and configuring the slat moving time (only with slatted blinds)

If blinds are used, the slats can be positioned independently. To enable the actuator to compute slat positions and to report them back to the bus, it is necessary that the actuator gets precise information about the time required for a slat rotation. The slat moving time must in each case be determined 'manually' and entered into the parameters.

The actuator is designed for controlling single-motor blind drives without working position. In this drive mode, the slats are directly adjusted by way of mechanical linkage when the height of the blind is changed. The actuator assumes that the slats are completely closed when the blind moves downwards. Similarly, the actuator assumes that the slats are completely open when the blind moves upwards (see picture 30). These blinds are the most common type on the market.

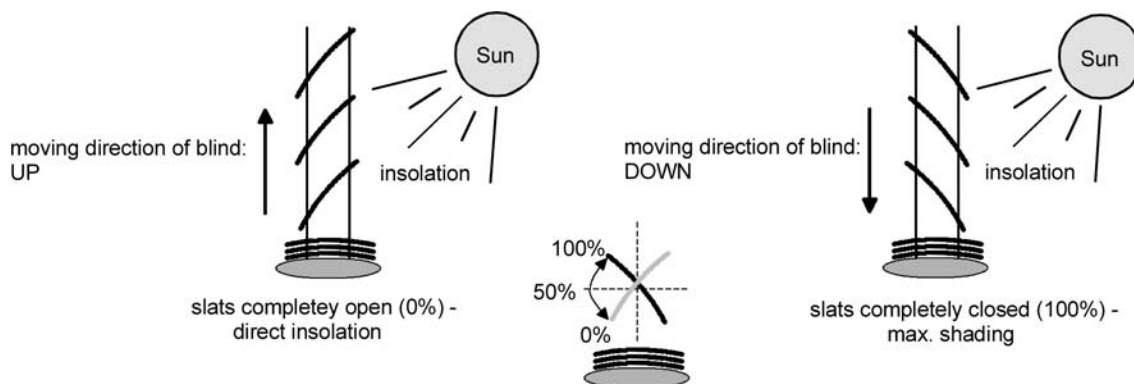

picture 30: type 1 - slatted blinds with oblique slat position in both travel directions

There are also single-motor blind systems without working position the slats of which are horizontal during an upward travel and oblique during a downward travel. Such blind types can also be connected to the actuator in which case a completely open slat position corresponds to the slats in horizontal position .

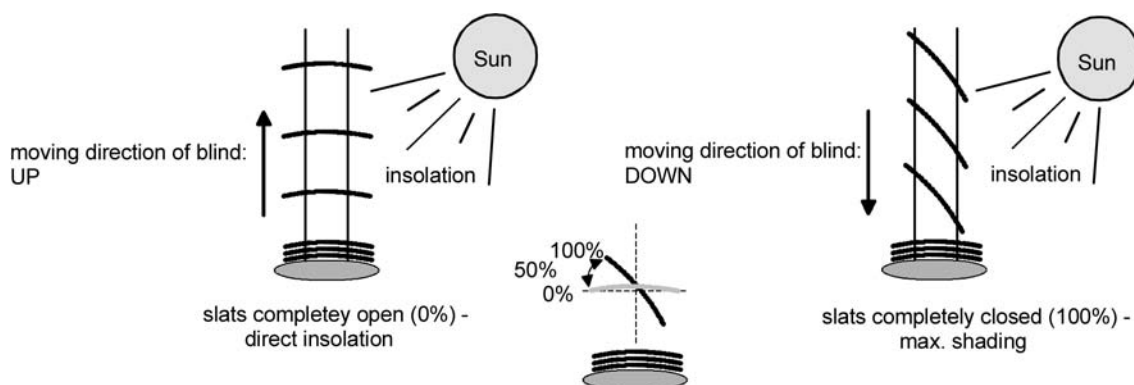

picture 31: Type 2 - slatted blinds with oblique and horizontal slat position

Presetting the slat moving time

The measurement of the slat moving time is described in detail in chapter "Commissioning".

- Set the parameter "Slat moving time" on parameter page "Ax – Times" (x = number pair of the output) exactly to the value determined in the course of the commissioning procedure.
- i** The slat moving time must be shorter than the preset or taught curtain travelling time.
- i** The parameterized or measured travelling time extension will also be taken into account when slats are moved into the completely open position (upward travel).

Determining and configuring the travelling time extension and the change-over time

When travelling upwards, blinds, shutters or awnings have a tendency of moving more slowly due to their own weight or to external physical influences (e.g. temperature, wind, etc.). The same applies to venting louvers where opening may take longer than closing.

For this reason, the actuator takes the parameterized travelling time extension into account when moving upwards or when opening louvers. The extension is computed as a percentage of the difference of the travelling times in both directions.

The travelling time extension must be determined during commissioning separately for each output and entered into the ETS parameters.

The measurement of the travelling time extension is described in detail in the chapter "Commissioning".

Example for determining the travelling time extension:

- "Travelling time" previously determined and parameterized: $T_{OU} = 20$ seconds,"
- Time determined for travel from lower to upper end position: $T_{UO} = 22$ seconds,
- Calculated supplementary travelling time: $T_{UO} - T_{OU} = 2$ seconds ->
2 seconds out of 20 seconds are 10 %,
- Travelling time extension to be parameterized: 10 %.

To protect the drive from irreparable damage, a fixed pause during travel direction change-over can be parameterized for each output – even with automatic end position detection. During the pause, no travel direction is active ("stop"). The necessary parameter value can normally be found in the technical documents of the drive motor used. The change-over time is accounted for in every state of operation of the actuator.

Presetting the travelling time extension

The automatic end position detection must be deactivated.

- Enter the determined travelling time extension (by rounding up the determined extension value) into the parameter "Travelling time extension for upward travel" on parameter page "Ax – General" (x = number pair of the output).

Presetting the change-over time for travel direction changes

- Set the parameter "Change-over time for travel direction changes" on parameter page "Ax – Times" (x = number pair of the output) to the required change-over interval.

i In the state of the actuator as supplied, the change-over time is generally preset to 1 s.

Computing the curtain height or the louver position

The actuator has a convenient and accurate positioning function. The actuator calculates the current position of the connected blind, shutter, awning or louver whenever these elements are adjusted either by manual or bus control. The calculated position value is a measure of the height of the curtain or of the opening width of the venting louver (see picture 32).

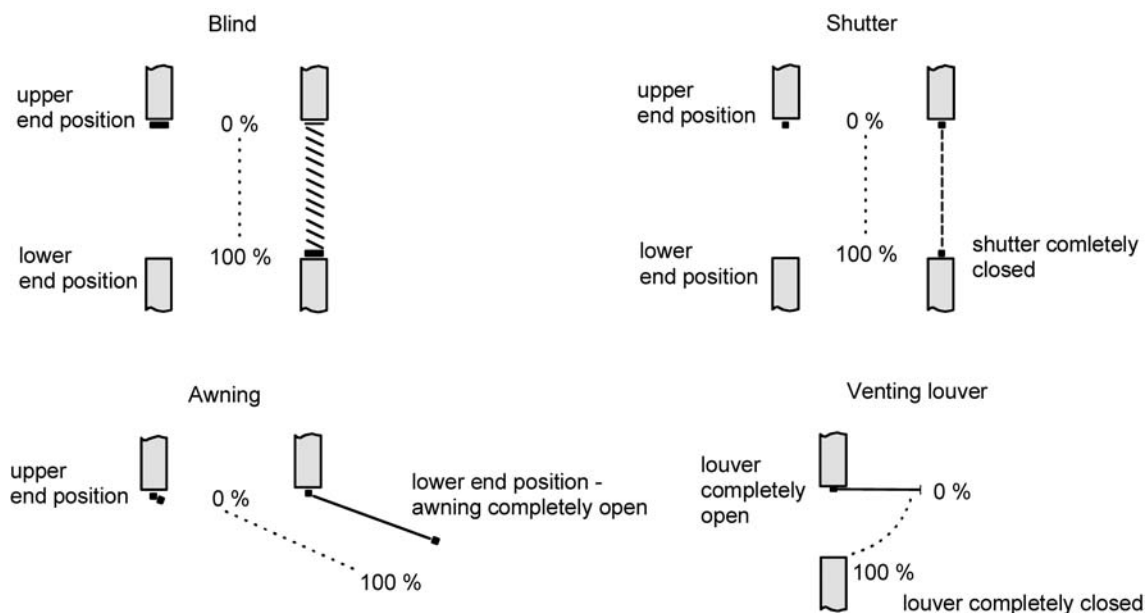

picture 32: Positions defined as a function of the type of movement

The actuator derives the positions from the parameterized travelling time since conventional drives do not provide feedback about their positions. Thus, the travelling time separately parameterized for each blind output is the reference for all position approaches and of basic importance for the accuracy of the position calculations. For this reason, the travelling times should be determined with great accuracy in order to achieve the best possible positioning results.

For positioning purposes, the actuator calculates the travelling time required as a function of the current position.

Example 1...

The shutter connected to a certain output has an overall travelling time of 20 s. The shutter is in its upper end position (0 %). It is to be positioned to 25 %. The actuator calculates the travelling time required for the positioning: $20 \text{ s} \times 0.25_{(25 \%)} = 5 \text{ s}$. The output will then lower the shutter for 5 s and thus position it at a height of 25 %.

Example 2...

The shutter connected to a certain output has an overall travelling time of 20 s. The shutter is in the 25 % position. It is to be positioned to 75 %. The difference between the positions is 50 %. The actuator calculates the travelling time required for bridging the difference between the positions: $20 \text{ s} \times 0.5_{(50 \%)} = 10 \text{ s}$. The output will then lower the shutter for 10 s and thus position it at a height of 75 %.

For all upwards travels the parameterized travelling time extension is automatically added to the calculated travelling time.

Example 3...

The shutter connected to a certain output has an overall travelling time of 20 s. The shutter is in the 75 % position. It is to be positioned to 25 %. The difference between the positions is 50 %. The actuator calculates the travelling time without extension required for bridging the difference between the positions:

$20 \text{ s} \times 0.5_{(50 \%)} = 10 \text{ s}$. Taking the travelling time extension into account (e.g. 10 %), the actual raising time is: $10 \text{ s} \times ((100 \% + 10 \%_{(\text{travelling time extension})}) \times 100 \%) = 10 \text{ s} \times 1.1 = 11 \text{ s}$. The output will then raise the shutter for 11 s and thus position the shutter curtain at a height of 25 %.

In addition, when the lower or upper end positions (0 % or 100 %) are approached, the travelling time is always 20 % longer than the overall travelling time.

Example 4...

The shutter connected to a certain output has an overall travelling time of 20 s. The shutter is in the 50 % position. It is to be positioned to 100 %. The difference between the positions is 50 %. The actuator calculates the travelling time required for bridging the difference between the positions: $20 \text{ s} \times 0.5_{(50 \%)} = 10 \text{ s}$. As the travel is a travel to an end position, the actuator adds a fixed percentage corresponding to 20 % of the overall travelling time: $10 \text{ s} + (20 \% : 100 \%) \cdot 20 \text{ s} = 14 \text{ s}$. The output will then lower the shutter for 14 s and thus position it at a height of 100 %.

Example 5...

The shutter connected to a certain output has an overall travelling time of 20 s. The shutter is in the 50 % position. It is to be positioned to 0 %. The difference between the positions is 50 %.

The actuator calculates the travelling time required for bridging the difference between the positions: $20 \text{ s} \times 0.5_{(50 \%)} = 10 \text{ s}$. As the travel is a travel to an end position, the actuator adds an additional fixed percentage corresponding to 20 % of the overall travelling time:

$10 \text{ s} + (20 \% : 100 \%) \times 20 \text{ s} = 14 \text{ s}$.

Taking the travelling time extension into account (e.g. 10 %), the actual raising time is:

$14 \text{ s} \times ((100 \% + 10 \%_{(\text{travelling time extension})}) \times 100 \%) = 14 \text{ s} \times 1.1 = 15.4 \text{ s}$. The output will then raise the shutter for 15.4 s and thus position it reliably to 0 %.

- i** The actuator executes position approaches only if a new position deviating from the current position is preset.
- i** The actuator stores the curtain or louver positions temporarily. The actuator can approach newly preset curtain or louver positions only if the current positions are known. For this purpose, each output must be given the opportunity to synchronize itself whenever the supply voltage is switched on or after every ETS programming run (physical address, application program). The synchronization is performed with the help of a reference travel (cf. "Reference travel").

- i** Position approaches in progress will be aborted in case of bus or mains voltage failure. In case of bus voltage failure, the parameterized behaviour will be executed. In case of mains failure, the drives will be stopped. Position approaches are also interrupted when the manual control mode is activated.

Calculating the slat position (only with blinds)

In the "blind" mode of operation, the actuator always calculates the slat position so that the opening angle and thus the amount of light admitted into the room by the blind can be adjusted. A new position approach by a blind will always be followed by a positioning movement of the slats. Thus, the slat positions last selected will be tracked or readjusted to a new value if a position change has taken place.

In case of single-motor blind drive systems without working position, the slats will be readjusted directly by a change in the height of the blind. For this reason, an adjustment of the slat position will always have an influence on the position of the blind itself (see picture 33).

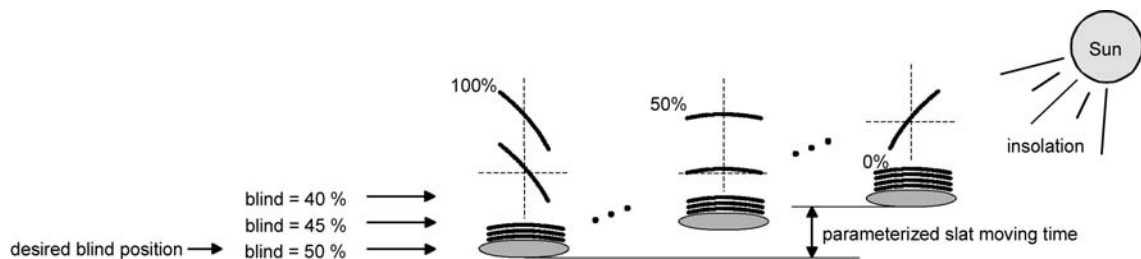

picture 33: Example of slat positioning affecting the position of the blind (typical of slat type 1; analogous reaction for type 2.)

Since a preset slat position is to remain constant until the next change, the actuator will not change the height of the blind, if the calculated travelling time required for a change of position lies within the parameterized slat moving time.

Similarly, the actuator accounts for the ratio of the moving times of slat and blind and – in case of slat position changes – always recalculates the resulting blind position. If the position feedback objects are used (cf. "Position feedback"), the actuator transmits the blind positions changed by the adaptation also to the bus.

Example (see picture 33)...

The blind position is preset to 50 %. A change of the slat angle (100 %...0 %) initiates the calculation of a new blind position which is also tracked in the position feedback objects. If the actuator is to approach a new blind position of, let's say 47 % in this case, the actuator will not perform a travel movement as the calculated travelling time lies within the parameterized slat moving time and therefore coincides with the slat movement. A change of the blind position to 55 % in this case triggers a blind movement as the change does not lie within the slat movement (0 to 100 %).

For each positioning movement, the nominal blind position is referred to a slat position of 100 %. In the event of a slat re-positioning movement (0 to 100 %), the actuator will therefore report a blind position below the nominal position.

Exception: The desired blind position of 0 % (upper end position) is assigned to the slat position of 0 %. The re-adjustment of the slat position will result also in this case in a change of the blind height (brief downward travel). Only in this case will the actuator report back a blind position above the desired blind position (see picture 34). With slat type 1, the slats are generally horizontal when the blind is in its upper end position. For this reason, the calculated slat position with a slat type 1 corresponds to the actual opening angle only after the first slat is completely extended (100%).

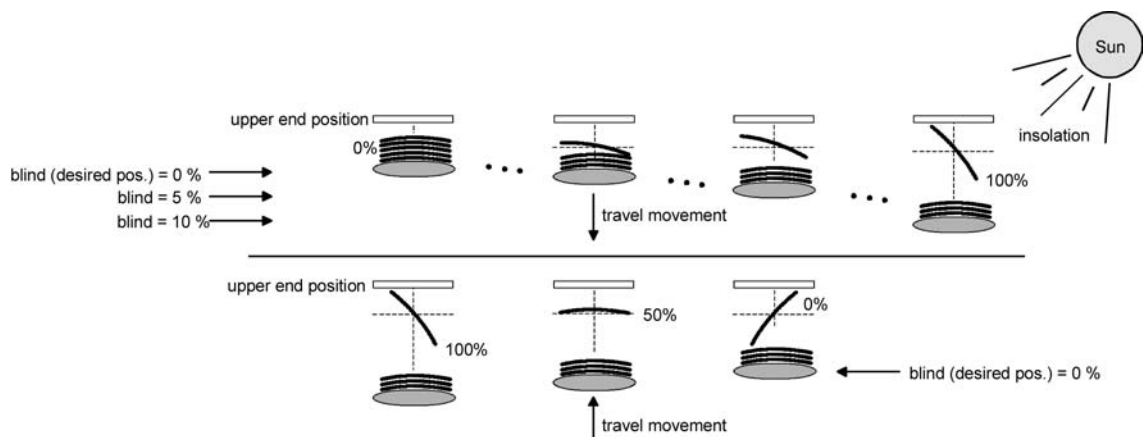

picture 34: Example of slat positioning with the blind in upper end position (typical of slat type 1.)

Example (see picture 34)...

The blind position is preset to 0 %. After an extended travel movement, the blind is safely in the upper end position. A change of the slat angle (0 %...100 %) initiates the calculation of a new blind position which is also tracked in the position feedback objects. If the actuator is to approach a new blind position of, let's say 5 % in this case, the actuator will not perform a travel movement as the calculated travelling time lies within the parameterized slat moving time and therefore coincides with the slat movement. A change of the blind position to 15 % in this case triggers a blind movement as the change does not lie within the slat movement (0 to 100 %).

- i** The actuator executes slat position adjustments only if a new position deviating from the current slat position is preset.
- i** The actuator stores the slat positions temporarily. The actuator can approach newly preset slat positions only if the current position is known. For this purpose, each output must be given the opportunity to synchronize itself whenever the supply voltage is switched on or after every ETS programming run (physical address, application program). The synchronization is performed with the help of a reference travel for the slat or the blind (cf. "Reference travel").
- i** A change of the blind height will always result in a change of the slat position. After reactivation of the supply voltage or after ETS programming, the actuator will in this case generally move the slats into the 100 % position, if no position has been preset for the slats.
- i** The smaller the ratio between slat moving time and blind travelling time, the more precise the position approaches and the less marked the influence of the slat angle adjustment on the height of the blind.

Reference travel

After ETS programming (physical address, application program, partial download) or after actuator supply voltage failure (bus and mains voltage) all current position data are unknown. Before the actuator can approach new positions after bus and mains voltage return or after programming, the positioning system must at first be calibrated. The positioning system can be calibrated by carrying out a reference travel.

A reference travel is the time required for a travel movement into the upper end position increased by 20 % and additionally by the parameterized travelling time extension (see picture 35). A reference travel is not retriggerable.

Reference travels can be executed by the following commands...

- an uninterrupted MOVE operation (including also a terminated safety travel) into the upper end position activated via the corresponding communication object,
- an approach of the 0 % position,
- a manually controlled movement into the upper end position.

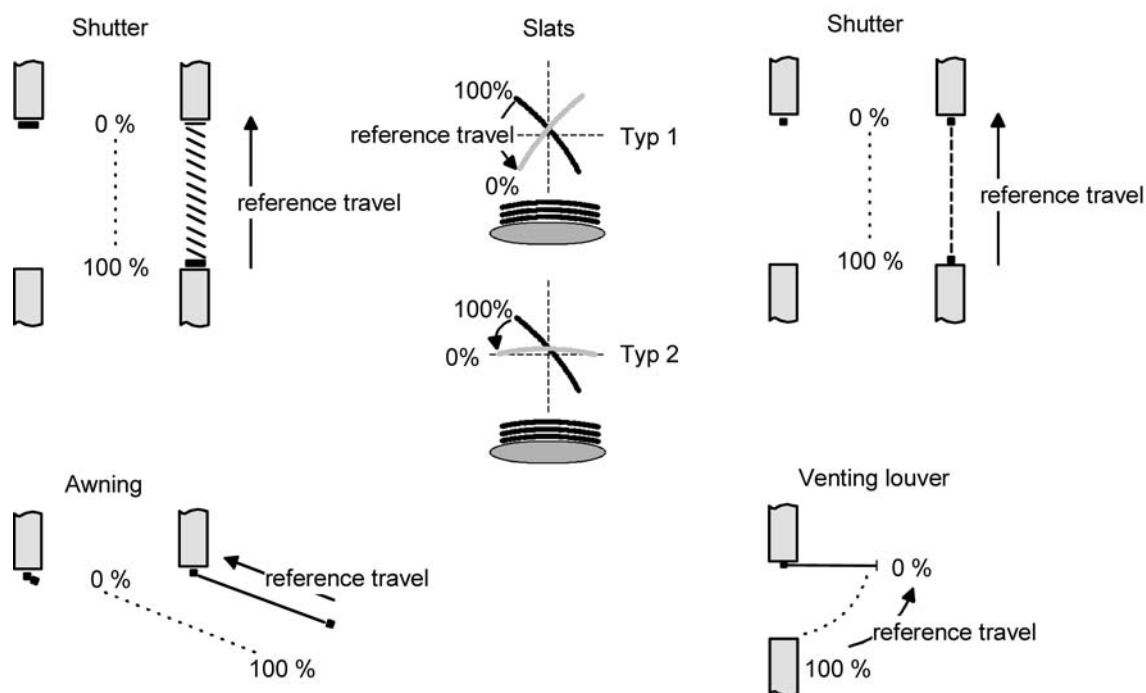

picture 35: Reference travel

In the event of slat positioning via the corresponding communication objects after bus and mains voltage return or after programming, a slat reference movement becomes necessary if the blind has not been moved beforehand in the up or down directions for at least the parameterized slat moving time. During a slat reference movement, the actuator always moves the slats for the parameterized slat moving time into the completely open position (0 %) and then to the desired position. The slat position is also considered as calibrated when the blind has been moved by a MOVE command in the up or down direction during at least the parameterized slat moving time.

- i** A terminated reference travel of the blind will also calibrate the slat position.
- i** If the reference travel is interrupted for instance by a STEP operation, the position is still unknown as before.
- i** A MOVE operation into the lower end position activated via the corresponding communication object also calibrates the reference position.
- i** With the sun protection function it is moreover possible to force the actuator to perform a reference travel before each sun protection travel even if the positions are known. Thus, it is ensured that in case of sun protection the parameterized sun protection position is always precisely approached even after repeated position approaches.
- i** Using the connected drives frequently for position approaches (for instance several times a day) can result after some time in positioning inaccuracies. These deviations from the nominal position are mostly due to external physical influences. To achieve accurate positioning in operation it is recommended to perform the reference travel at least once every day. This can be achieved for instance by a central raising command transmitted to the MOVE object.

Presetting the position

The following ways of presetting positions can be distinguished...

- direct positioning via the positioning objects (direct operation),
- positioning by activating the sun protection function,
- positioning by the behaviour after bus voltage failure or bus or mains voltage return,
- positioning by a scene recall.

positioning via the positioning objects:

Every blind, shutter, awning or louver can be positioned directly via the "Position..." object separate for each output. An independent positioning object exist equally for the slats. The position approached is always the position last received. The actuator shows no reaction when the preset position value or the position to be approached is received several times in succession. Like the operation via STEP, MOVE or central objects, this form of control is also designated as 'direct operation'. Positioning via the objects therefore has the same priority.

A position approach effected by the communication objects can be interrupted at any time by a STEP, MOVE or central command or by a scene recall. The direct operation can be overridden by a function with a higher priority, e.g. manual control, forced position, safety or also sun protection (parameterizable).

The position telegrams must conform to the 1-byte data format as per KNX datapoint type 5.001 (scaling). The actuator converts the value received (0...255) linearly into a position (0...100 %) (see Table 2).

value received (0...255)	position derived from value (0...100 %)
0	0 % (upper end position / slat or louver opened)
↓	↓ (all intermediate values rounded off to 1 % increments)
255	100 % lower end position / slat or louver closed)

Table 2: Data format of positioning objects with conversion into percentage position values

It is possible that new positioning telegrams are being received while a position approach is in progress. In this case, the actuator immediately reverses the direction of travel, if the new position to be approached lies in the opposite direction.

If a slat positioning command is received during a running blind position approach, the actuator finishes first the blind position approach before positioning the slat. If a blind positioning command is received during a slat positioning movement, the actuator interrupts the slat positioning movement and approaches the new blind position. The slat positioning command last received will only be executed after the blind position is reached.

In case of blind positioning, slat positioning will always be tracked. After switching on the power supply of the actuator or after programming with the ETS, it may be the case that the slat position is unknown, if no MOVE command for the upward or downward travel with a duration of at least the parameterized slat moving time has been received or no slat positioning has taken place (no slat reference movement). In this case, the slat is moved during a blind position approach into the completely closed position (100 %). The slat position is then considered as calibrated.

i Optionally, the sun protection function offers the possibility of receiving the instruction of the curtain height, venting louver or slat position to be adopted during sunshine via separate communication objects and to preset these values variably. This form of variable position preset in the sun protection function is identical to presetting the positions via communication objects in the direct operation mode. The priority of the incoming telegrams in direct operation with the sun protection activated can be additionally parameterized.

Positioning by the sun protection function, the behaviour after bus voltage failure or bus or mains voltage return or by a scene recall:

In case of the actuator functions mentioned, the positions to be approached are parameterized directly in the ETS depending on the mode of operation. The position values can be specified between 0 % and 100 % in 1 % steps.

With blinds, the height of the blind is positioned first in these cases. The parameterized slat position is adjusted only thereafter.

- i** Important notes for all positioning movements: Using the connected drives frequently for position approaches (for instance several times a day) can result after some time in positioning inaccuracies. These deviations from the nominal position are mostly due to external physical influences. To achieve accurate positioning in operation it is recommended to perform the reference travel at least once every day. This can be achieved for instance by a central raising command transmitted to the MOVE object.

Position feedback messages

In addition to presetting positions via positioning objects, the actuator can track the current position values via separate feedback objects and also transmit them to the bus, if the bus voltage is on. Thus, the preset nominal position can be distinguished from the true actual position of the drives activated.

The following feedback telegrams can be preset for each output depending on the parameterized mode of operation...

- Feedback (1 byte) of the blind, shutter, awning or venting louver position,
- Feedback (1 byte) of the slat position (only with blinds).

The individual position feedback messages can be enabled in the ETS independent of one another and have communication objects of their own.

For each travel movement the actuator calculates the current position and tracks it in the position feedback objects. The positions are tracked and the feedback objects updated even when an output has been activated via STEP or MOVE telegrams or by manual control on condition that the bus voltage is on.

The feedback objects are updated after the following events...

- at the end of a travel movement – including a slat positioning movement in a blind – when the drive stops and when the new position is reached,
- in case of a travel movement into an end position already at the time the end position is reached theoretically, i.e. before the 20 % extension and the travelling time extension have elapsed.

The feedback objects are not updated if the position last reported back has not changed after a movement (e.g. when the blind is repositioned, the unchanged slat position will not be reported back a second time).

The actuator cannot calculate a feedback position if the current position data after switch-on of the supply voltage (bus voltage and mains voltage) or after ETS programming are still unknown. In these cases, the actuator must first perform a reference travel (cf. "Reference travel") so that the position can be calibrated. In case of unknown positions, the actuator automatically performs reference travels if new positions are preset and if these positions are to be approached. As long as a position is unknown, the value of the feedback objects is "0".

Presetting position feedback for blind, shutter, awning or venting louver positions

The feedback functions can be enabled and programmed independently for each output. When feedback is enabled, the ETS adapts the parameter texts depending on the preset operating mode ("Blind position feedback", "Shutter/awning position feedback" or "Venting louver position feedback"). The status feedback can be used as an active signalling object or as a passive status object. As an active signalling object, the position feedback information is transmitted to the bus whenever a position value changes. As a passive status object, there is no telegram transmission after a change. In this case, the object value must be read out. The ETS automatically sets the object communication flags required for proper functioning. In case of an actively transmitting signalling object, the current position can be transmitted to the bus after bus voltage return if the position value differs from the one last transmitted. When

the position data are known, the feedback telegram can in this case be transmitted with a time delay to reduce the bus load, with the delay being preset globally for all outputs in common (cf. "Delay after bus voltage return").

The feedback functions of an output must be enabled on parameter page "Ax – Enabled functions" (x = number pair of the output). Only then are the parameters for the feedback functions visible.

- Set the parameter "Blind position feedback", "Shutter/awning position feedback" or "Venting louver position feedback" on parameter page "Ax – Feedbacks" to "feedback object is active signalling object".

The feedback object is enabled. The position value is transmitted as soon as it changes. No value will be actively transmitted, if the position is unknown.

- Set the parameter "Blind position feedback", "Shutter/awning position feedback" or "Rückmeldung Lüftungsklappenposition" on parameter page "Ax – Feedbacks" to "feedback object is passive status object".

The feedback object is enabled. The position value will be transmitted in response only if the feedback object is read out by the bus. If the position is unknown, a value of "0" will be reported back after readout.

The feedback function must be preset as an actively transmitting function.

- If a time delay after bus voltage return should be necessary, the parameter "Time delay for feedback after bus voltage return" on parameter page "Ax – Feedbacks" must be set to "yes".

The position is then reported back with a time delay after bus voltage return. After the end of the time delay, the position last adjusted statically will be transmitted to the bus. No feedback telegram will be transmitted during a running delay, even if a position value changes during this delay.

Presetting the position feedback for slat positions (only with blinds)

The feedback functions for the slat positions can be enabled and programmed independently for each output. The status feedback can, like the position feedback for the height of the blind, be used as an active signalling object or as a passive status object.

In case of an actively transmitting signalling object, the current slat position can be transmitted to the bus after bus voltage return if the position value differs from the one last transmitted. When the position data are known, the feedback telegram can in this case be transmitted with a time delay to reduce the bus load, with the delay being preset globally for all outputs in common (cf. "Delay after bus voltage return").

The feedback functions of an output must be enabled on parameter page "Ax – Enabled functions" (x = number pair of the output). Only then are the parameters for the slat position feedback functions visible.

- Set the parameter "Slat position feedback" on parameter page "Ax – Feedbacks" to "feedback object is active signalling object".

The feedback object is enabled. The position value is transmitted as soon as it changes. No value will be actively transmitted, if the position is unknown.

- Set the parameter "Slat position feedback" on parameter page "Ax – Feedbacks" to "feedback object is passive status object".

The feedback object is enabled. The position value will be transmitted in response only if the feedback object is read out by the bus. If the position is unknown, a value of "0" will be reported back after readout.

The feedback function must be preset as an actively transmitting function.

- If a time delay after bus voltage return should be necessary, the parameter "Time delay for feedback after bus voltage return" on parameter page "Ax – Feedbacks" must be set to "yes".

The position is then reported back with a time delay after bus voltage return. After the end of the time delay, the position last adjusted statically will be transmitted to the bus. Although the feedback object concerned is updated during a running delay, no feedback telegram will, however, be actively transmitted during such delay, even if a position value changes during the delay.

- i** Behaviour of position feedback in case of voltage failure and voltage return:
When the bus voltage returns, with the mains voltage supply to the actuator being on, the current position data are always written into the feedback objects. The positions are transmitted to the bus also in those cases where the feedback objects are actively transmitting objects and where the position data differ from the data last reported back, for instance, as a result of manual control. If the position data are unknown, the feedback objects are initialised with "0" and are not transmitted to the bus.
Without mains voltage supply, the connected drives are not activated so that there is always no position feedback, even after return of the bus voltage. In case of mains voltage return, the parameterized behaviour will be executed. The feedback objects are then updated provided the bus voltage is on.
- i** In case of blinds operation, any position change of the blind within the limits of the slat adjustment (0 to 100 %) does not launch a travel movement and therefore no change of the feedback position data either.

'Unknown position' feedback and travel movement

In addition to position data feedback, the actuator can also report back enlarged 1-bit status information messages and transmit them actively to the bus, if the bus voltage is on.

The following status feedback messages can be preset separately for each output...

- invalid position feedback message,
- Travel movement feedback message.

invalid position feedback message:

After switch-on of the supply voltage (bus and mains voltage) or after programming with the ETS, all position data of an output are unknown. In this case – when the bus voltage is on – the actuator can update the feedback object "Invalid position"(object value "1") which will then signal that the object values of the 1-byte position feedback objects are invalid.

An invalid position feedback will be only be reversed (object value "0") after the position data for the blind, shutter, awning or venting louver have been calibrated by means of a reference travel. The calibration of the slat position in a blind alone will not result in the reversal of an 'invalid position' status message.

As an option, the object value of the status feedback message can be actively transmitted to the bus in case of a value change.

Travel movement feedback message:

The actuator can report back via a separate 1-bit communication object per output whether the connected drive is moving, i.e. whether the output is supplying current for any of the travel directions. The feedback object has a value of "1" when current is flowing from the output to the drive. Likewise, a "0" is written into the object if the output concerned remains in a stop position. In this case, the operation by which the output was activated (STEP or MOVE operation, positioning, manual control, etc.) is of no importance.

As an option, the object value of the status feedback message can be actively transmitted to the bus in case of a value change.

A mains voltage failure in the actuator always results in a "0" being written into the "Travel movement" feedback object. Moreover, the feedback status is derived exclusively from the relay state of the actuator. This means that if a drive is blocked or already in its end position, the value reported back does not correspond to the actual state of the travel movement.

Presetting an 'invalid position' feedback

The feedback for an invalid position can be enabled and programmed independently for each output. When feedback is enabled, the ETS adapts the parameter texts depending on the pre-set operating mode ("Invalid blind position feedback", "Invalid shutter/awning position feedback" or "invalid venting louver position feedback").

The status feedback can be used as an active signalling object or as a passive status object. As an active signalling object, the status feedback information is transmitted to the bus whenever a position value changes. As a passive status object, there is no telegram transmission after a change. In this case, the object value must be read out. The ETS automatically sets the object communication flags required for proper functioning.

If the object is an actively transmitting signalling object, the feedback telegram can be transmitted after bus voltage return with a time delay to reduce the bus load, with the delay being preset globally for all outputs in common (cf. "Delay after bus voltage return").

The feedback functions of an output must be enabled on parameter page

"Ax – Enabled functions" (x = number pair of the output). Only then are the parameters for the feedback functions visible.

- Set the parameter "Invalid blind position feedback", "Invalid shutter/awning position feedback" or "Invalid venting louver position feedback" on parameter page "Ax – Feedbacks" to "feedback object is active signalling object".

The feedback object is enabled. A telegram is transmitted as soon as there is a change (e.g. after ETS programming, after switch-on of the supply voltage or after a reference travel).

- Set the parameter "Invalid blind position feedback", "Invalid shutter/awning position feedback" or "Invalid venting louver position feedback" on parameter page "Ax – Feedbacks" to "feedback object is passive status object".

The feedback object is enabled. A telegram will be transmitted in response only if the feedback object is read out by the bus.

The feedback function must be preset as an actively transmitting function.

- If a time delay after bus voltage return should be necessary, the parameter "Time delay for feedback after bus voltage return" on parameter page "Ax – Feedbacks" must be set to "yes".

An invalid position is reported back with a time delay after bus voltage return. After the end of the time delay, the object value state last adjusted will be transmitted to the bus. No feedback telegram will be transmitted during a running delay. This is also the case if a position value becomes known, for instance, after a reference travel.

- i** Automatic transmitting after bus voltage return will take place only if an internal change of the object state has occurred (caused, for instance, by a reference travel during manual control).

Presetting the travel movement feedback

The travel movement feedback messages can be enabled and programmed separately for each output. The status feedback can be used as an active signalling object or as a passive status object. As an active signalling object, the status feedback information is transmitted to the bus whenever an object value changes. As a passive status object, there is no telegram transmission after a change. In this case, the object value must be read out. The ETS automatically sets the object communication flags required for proper functioning.

If the object is an actively transmitting signalling object, the feedback telegram can be transmitted after bus voltage return with a time delay to reduce the bus load, with the delay time being preset globally for all outputs in common (cf. "Delay after bus voltage return").

The feedback functions of an output must be enabled on parameter page

"Ax – Enabled functions" (x = number pair of the output). Only then are the parameters for the feedback functions visible.

- Set the parameter "Travel movement feedback" on parameter page "Ax – Feedbacks" to "feedback object is active signalling object".

The feedback object is enabled. A telegram is transmitted when the connected drive starts moving or stops.

- Set the parameter "Travel movement feedback" on parameter page "Ax – Feedbacks" to "feedback object is passive status object".

The feedback object is enabled. A telegram representing the current travel movement will be transmitted in response only if the feedback object is read out by the bus.

The feedback function must be preset as an actively transmitting function.

- If a time delay after bus voltage return should be necessary, the parameter "Time delay for feedback after bus voltage return" on parameter page "Ax – Feedbacks" must be set to "yes".

A travel movement feedback telegram is transmitted with a time delay after bus voltage return, for instance when the drive is set in motion as a result of the preset behaviour after bus voltage return. After the end of the time delay, the object value state last adjusted will be transmitted to the bus. No feedback telegram will be transmitted during a running delay. This is also the case if the drive stops or starts moving during this delay.

- i** Automatic transmitting after bus voltage return will take place only if the drive starts moving on return of bus voltage or if there has been a change of the travel movement caused by the bus failure.

Safety function

The actuator can handle up to five different safety functions:

3 x wind alarm, 1 x rain alarm, 1 x frost alarm. Each safety function has a communication object of its own so that the functions can be activated or deactivated independently of one another.

The safety functions are programmed and configured for all shutter/blind outputs together (cf. chapter "Description of channel-independent functions – Safety functions").

The different outputs of the actuator can be separately assigned to all or to individual safety functions. Only assigned outputs react to a change of state of the safety objects. The reactions at the beginning of an alarm ("1" telegram) can be parameterized for each alarm separately whereas the reaction at the end of an alarm ("0" telegram) can be parameterized for all alarms in common (see picture 36).

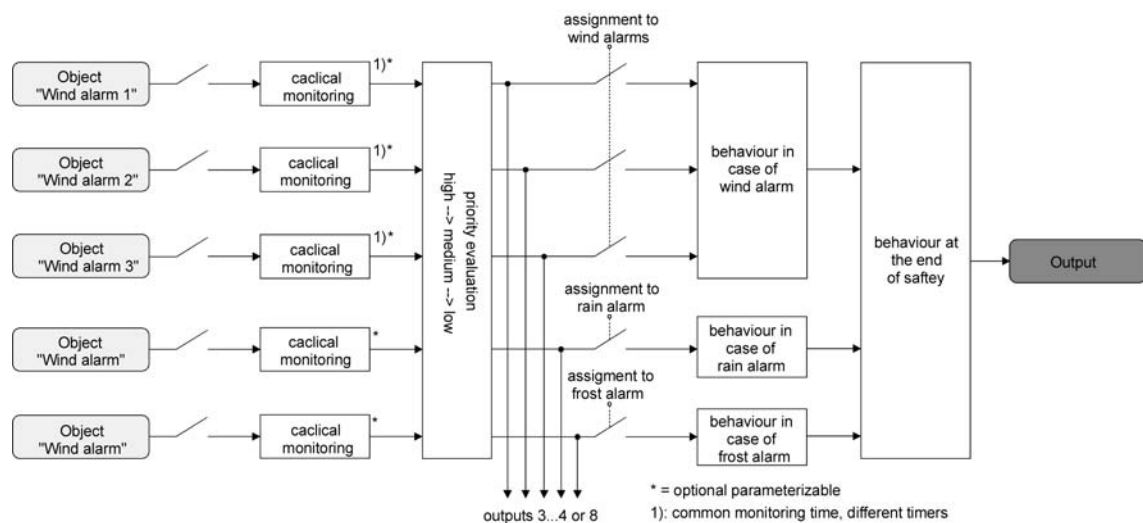

picture 36: Function diagram of channel-oriented safety functions

An output can be assigned independently to the wind alarms, the rain alarm and the frost alarm. If an output is associated with several alarms, the preset priority decides which of the alarms will prevail and be executed. An alarm with a higher priority overrides the alarms with the lower priorities. When a safety alarm with the higher priority has ended, the safety alarm with the lower

priority is executed on condition that it is active.

The order of priority of the wind alarms with respect to the frost alarm or to the rain alarm can be parameterized independent of the channel on the "Safety" parameter page. The three wind alarms have the same priority with respect to one another (logic OR). The last telegram update to the wind alarm objects decides which of the wind alarms will be executed. The wind alarm is completely deactivated only after all three objects are inactive ("0").

An output in the active safety alarm state is locked, i.e. the control of the output concerned via the bus by direct operation (STEP, MOVE telegram, scenes, positioning, central) or by a sun protection function is prevented. Only a forced position and a manual control locally on the device itself have a higher priority so that these functions may override a safety interlock. At the end of a forced position or of a manual control, the safety reaction is re-executed if an assigned safety alarm is still active.

Assigning safety alarms

The individual safety alarms can be assigned separately to each output. The channels are assigned on parameter page "Ax – Safety" (x = number pair of the output).

The safety functions must be globally enabled on the "Safety" parameter page before the output assignments are configured.

The safety function for an output must be enabled on parameter page "Ax – Enabled functions" (x = number of output). Only then are the channel-related parameters for the safety function visible.

- If an assignment to the wind alarms is necessary, set the parameter "Assignment to wind alarms" to the wind alarm or the wind alarms required.

The output is assigned to the specified wind alarms.

- If an assignment to the rain alarm is necessary, set the parameter "Assignment to rain alarm" to "yes".

The output is assigned to the rain alarm.

- If an assignment to the frost alarm is necessary, set the parameter "Assignment to frost alarm" to "yes".

The output is assigned to the frost alarm.

i If an output is assigned to an alarm which is not globally enabled, the assignment is without effect.

i Important information about the activation or deactivation of a safety alarm, about the pre-setting of the priority and about cyclical monitoring can be found in chapter "Channel-independent functional description – Safety functions".

Presetting the behaviour at the beginning of a safety alarm

The behaviour of an output at the beginning of a safety alarm can be parameterized separately for each alarm (wind alarms in common, rain and frost alarms separately). The alarm behaviour is preset on parameter page "Ax – Safety" (x = number pair of the output). At the beginning of a safety alarm, the actuator locks the outputs concerned so that controlling via the bus by direct operation or by a sun protection function is prevented.

Depending on the selected mode of operation, the ETS adapts the designations of the parameter settings ("raising" ↔ "opening the louver" / "lowering" ↔ "closing the louver").

The safety functions must be globally enabled on the "Safety" parameter page.

The safety function for an output must be enabled on parameter page "Ax – Enabled functions" (x = number of output). Only then are the channel-related parameters for the safety function visible.

The behaviour in case of a safety alarm can only be adjusted, if the output concerned has been assigned to the corresponding alarm. Since there is no difference between the alarm-dependent parameterizations, the selection of the parameters is described below only once.

- Set the parameter "Behaviour in case of ..." to "no reaction".

At the beginning of the alarm, the output is locked and the relay of the output shows no reaction. Any travel movements still in progress at this instant will still be completely finished.

- Set the parameter "Behaviour in case of ..." to "raising" or "opening the louver".
The actuator raises the curtain or opens the venting louver at the beginning of the alarm and locks the output thereafter.
 - Set the parameter "Behaviour in case of ..." to "lowering" or "closing the louver".
The actuator lowers the curtain or closes the venting louver at the beginning of the alarm and locks the output thereafter.
 - Set the parameter "Behaviour in case of ..." to "stop".
At the beginning of the alarm, the actuator switches the relays of the output to "stop" and locks the output. A travel movement, if any, will be interrupted.
- i** The safety travelling time required by an output to move the drive into the end positions is determined by the "Travelling time" parameter on parameter page "Ax - Times". Like MOVE operation, a safety travel is derived from the travelling time. Downward travel: travelling time + 20 %; Upward travel: travelling time + 20 % + parameterized travelling time extension. Safety travels are not retriggerable.
- i** Slats of blinds are not repositioned at the end of safety travels into end positions.

Presetting the behaviour at the end of all safety alarms

The actuator ends the safety interlock of an output only after all safety alarms assigned to the output have become inactive. Thereafter, the output concerned shows the parameterized "Behaviour at the end of safety". The behaviour is parameterized in common for all alarms on parameter page "Ax – Safety" (x = number pair of the output). Depending on the selected mode of operation, the ETS adapts the designations of the parameter settings ("raising" ↔ "opening the louver" / "lowering" ↔ "closing the louver").

The safety functions must be globally enabled on the "Safety" parameter page.

The safety function for an output must be enabled on parameter page "Ax – Enabled functions". Only then are the channel-related parameters for the safety function visible.

- Set the parameter "Behaviour at the end of safety" to "no reaction".
At the end of all safety alarms, the output is released and the relay of the output shows no reaction. Any travel movements still in progress at this instant will still be finished.
- Set the parameter "Behaviour at the end of safety" to "raising" or "opening the louver".
The actuator releases the output at the end of all safety alarms and raises the curtain or opens the venting louver.
- Set the parameter "Behaviour at the end of safety" to "lowering" or "closing the louver".
The actuator releases the output at the end of all safety alarms and lowers or closes the venting louver.
- Set the parameter "Behaviour at the end of safety" to "stop".
At the end of all safety alarms, the output is released and the actuator switches the relays of the output to "stop". A travel movement, if any, will be interrupted.
- Set the parameter "Behaviour at the end of safety" to "position tracking".
At the end of all safety alarms, the output will be set to the state last adjusted statically before the safety function or to the state tracked and internally stored during the safety function. The position objects, the MOVE object and the scene function are tracked.

- i** Parameter setting "position tracking": The actuator can track absolute positions when the safety function is terminated (position telegram, scene value) only if the position data are known and if the positions have been predefined. Otherwise no reaction is executed at the time the safety function is terminated.
Position data can be tracked if the output was in a defined position before the safety function or if a new position telegram was received via the position objects during the safety interlock. In the latter case, a reference travel will be executed when the safety function is terminated, if the position before or during the safety interlock was unknown.
Known slat positions will also be tracked as described. This is also the case, when the height of the blind is unknown.
MOVE operations (movement without a preset position) are always tracked, however.
- i** The preset "Behaviour at the end of safety" will only be executed if the output passes over to direct operation at the end of all safety alarms. If a sun protection function is activated (independent of the preset priority with respect to direct operation), it will also be executed.

Sun protection function - General information

Each output of the actuator can be separately configured for the execution of a sun protection function. Sun protection is generally realized with blinds, shutters or awnings and offers an intelligent method of shading rooms, terraces or balconies during sunshine depending on the altitude of the sun in the sky and on the intensity of the sunlight(see picture 37)

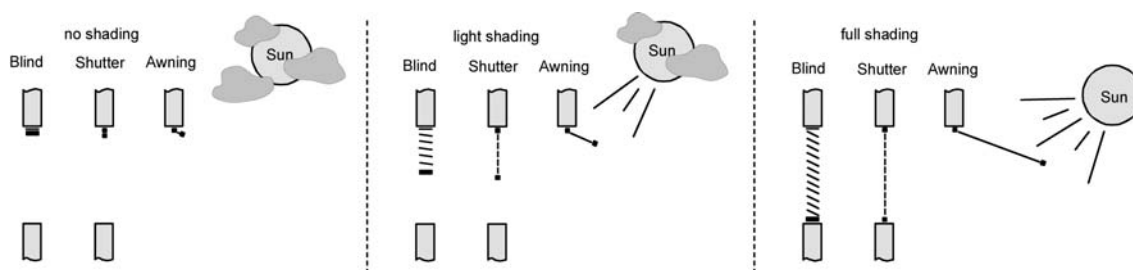

picture 37: Sun protection principles (example)

The sun protection functions of the actuator can be adapted to many different applications. In simple applications as, for instance, in case of direction-dependent measurement of the sun's intensity by means of a brightness sensor, the curtains controlled can be closed partly or completely to prevent being disturbed by direct sunlight. In these applications, the sun protection function merely evaluates the 1-bit sun signal from the brightness or a similar sensor (e.g. weather station with limit value monitoring) and makes a drive open or close the controlled curtains by moving them into fixed parameterized positions or into variable positions preset via the bus.

In extended applications – for instance where the degree of shading is controlled by weather stations evaluating additionally the sun angle as a function of astronomical coordinates and pre-setting the blind and also the slat positions dynamically – the sun protection function can be supplemented by an automatic control system. In such applications, the sun protection function evaluates additional bus communication objects allowing to enable or to disable the automatic control while the actuator is in operation. This results in a large number of combination variants with intelligent blinds control systems.

Even simple sun protection applications are sufficient to permit a fixed or variable re-adjustment of the positions of blind slats for adaptation to individual shading requirements. For such purpose, it is possible to preset a static slat offset in the ETS parameters, for example for adapting the reflection of sunlight depending on the building situation, or additionally, a dynamical slat offset via a bus communication object, for instance, for manual re-adjustment of the slat opening by persons in the room or otherwise by a central building services control system.

In all cases, the priority between an incoming sunshine or automatic telegram and the direct operation of an output (STEP, MOVE telegram, scenes, positioning, central) is also presettable in the ETS. This way, a sun protection position can, for instance, be influenced by a 'manual' oper-

ation of a touch sensor in the room and the sun protection function be interrupted. Alternatively, the sun protection mode can not be interrupted by a direct operation, i.e. the output is inter-locked.

A sun protection function can be overridden by a safety function, a forced position or also by a manual control locally on the device itself as these functions of the actuator invariably have a higher priority. At the end of one of the mentioned functions with a higher priority, the same reaction as the one at the beginning of sun protection will be re-executed, if the sun protection function is still active at this time.

The actuator can be operated with two sun protection functions. The simple sun protection or alternatively the enlarged sun protection that can be enabled.

Sun protection function - Simple sun protection

In the simple sun protection, shading against sunlight is activated and deactivated via the 1-bit communication object "Sunshine / shading facade". The polarity of this object can be selected in the ETS. The sun protection is activated as soon as "sunshine" is signalled to the object depending on the preset polarity. After ETS programming or after switch-on of the supply voltage, the object must at first have data written into it by the bus also in case of inverted polarity before the sun protection can be activated.

A newly received object value (sun / beginning of shading or sun / end of shading) can optionally be evaluated with a time delay. This feature permits suppressing brief brightness variations caused, for instance, by passing clouds or by a thunderstorm. An update (from activated to activated) of the "Sunshine / shading facade" object causes the sun protection to be reactivated, if it had been influenced and possibly been re-enabled beforehand by a direct operation in acc. with the preset priority.

The reaction of a specific output at the beginning of shading can be preset in the ETS. This setting permits, among other things, approaching fixed parameterized positions or positions preset via the bus and thus variable. Variable positions for sun protection purposes can be preset, for instance, by means of touch sensors or visualizations. In addition, it is possible in case of a defined sun protection positioning movement to have a reference travel executed by forced control. This ensures that identical curtain positions are approached synchronously by different outputs in case of a sun protection positioning movement.

The reaction at the end of a shading task can be preset as well. In this situation, the curtain can move to an end position, be stopped or show no special reaction. Tracking of positions is possible as well.

By means of a priority setting in the ETS parameters it can be specified whether the sun protection function can be influenced by operation or whether the corresponding output is locked by a telegram "Sunshine / shading facade" in the sun protection position. Basically, the "Manual control", "Forced position" and "Safety" functions have a higher priority so that these functions can override, but not terminate a sun protection. Thus, the sun protection function is re-executed at the end of a function with a higher priority, if the object "Sunshine / shading facade" continues to signal the presence of sunshine.

- i** The following rules must be observed for the enlarged sun protection: After an ETS programming operation, the sun protection function including automatic operation is always deactivated. An activated sun protection (independent of the selected priority with respect to direct operation) remains active even after a bus voltage failure as long as the mains voltage supply is still on. The sun protection reaction last executed will therefore be executed again at the end of a temporary or permanent manual control (if enabled in case of bus failure), even if there is no bus voltage.

The schematic diagram of the simple sun protection (see picture 38) and an example of how sensor components can be integrated into a simple sun protection configuration.

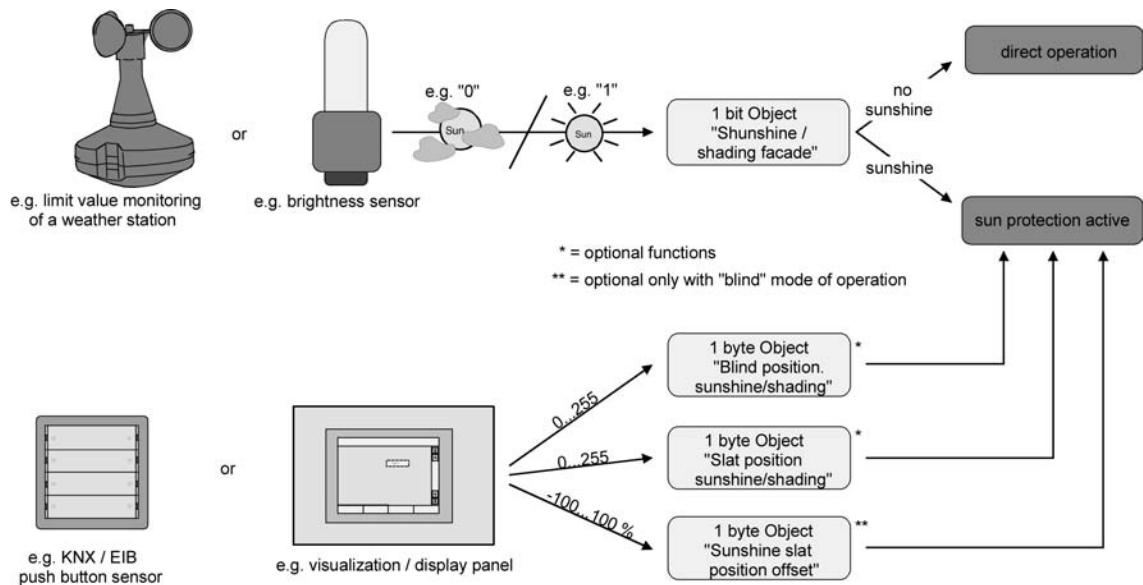

picture 38: Schematic diagram illustrating the simple sun protection configuration

The function diagram (see picture 39) shows all possible functions of the simple sun protection. For reasons of clarity, the functions with a higher priority (manual control, forced position, safety function) are not shown in the diagram.

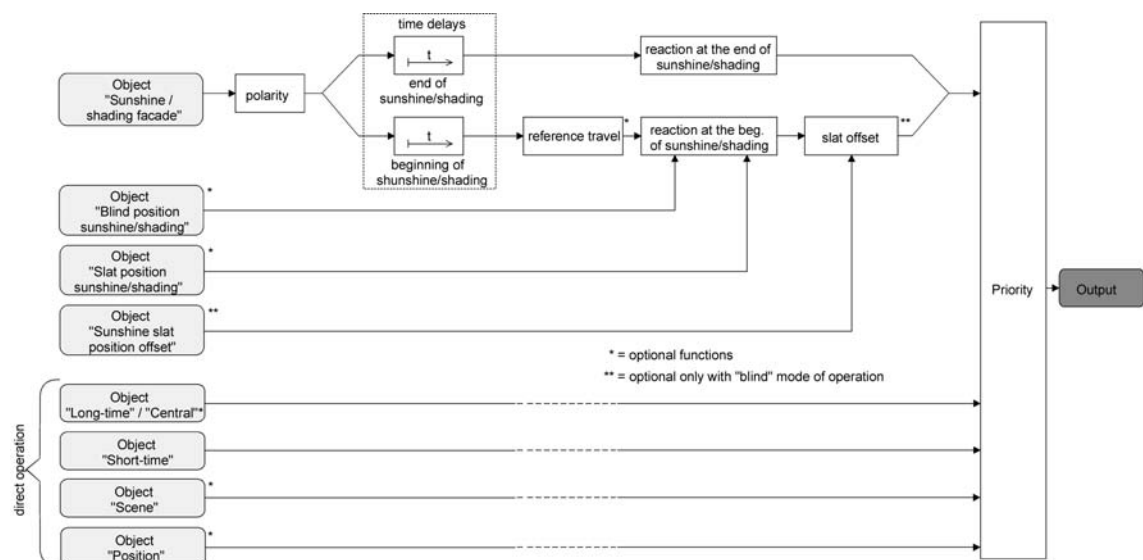

picture 39: Function diagram illustrating the simple sun protection

Sun protection function - Enlarged sun protection

The enlarged sun protection has the basic functional properties of the simple sun protection function. In addition, an automatic control system can be implemented. Blind control systems for blind and slat position tracking with respect to the position of the sun as, for instance, a weather station with combination sensor can therefore be integrated into the actuator system via the bus as an added automatic function.

In the enlarged sun protection, shading against sunlight is activated and deactivated via the 1-bit communication object "Sunshine / shading facade". A reaction of the output to the sun telegram can be expected only after the automatic control has been activated. In all other cases, the sun protection function is completely deactivated.

As far as the activation of the automatic control via the corresponding object is concerned, the following two cases must be distinguished...

- Sun shading action starting immediately:
Automatic operation is activated as soon as the object "Automatic" receives a "1-telegram". The output reacts immediately to the activation and shows the preset behaviour depending on sunlight conditions (Sun / beginning of the shading action / Sun end of the shading action). The sunlight conditions are derived from the object "Sunshine / shading facade" depending on the preset polarity and, if applicable, after the end of the delays.
After an ETS programming operation or after switch-on of the supply voltage, the object "Sunshine / shading facade" is initialised with "0" and, unlike the simple sun protection, evaluated immediately depending on the preset polarity so that shading against sunlight can begin immediately on activation of the automatic sun protection function. The reception of a "0" telegram by the object "Automatic" always terminates an automatic operation independent of the state of the "Sunshine / shading facade" object.

Application example:

A private house with winter garden. The winter garden is equipped with blinds to shade the place against sunlight. When the winter garden is used, the automatic operation is activated, for instance, with a touch sensor on the wall. The actuator will then start the shading action immediately, if sunshine has been detected beforehand.

The actuator performs the behaviour parameterized for the end of the sunshine / shading action in case no sunshine is detected when the automatic operation is activated.

- Sun shading action activated only at the next update:
In this configuration, the polarity of the automatic object can be preset. Automatic operation is activated as soon as the "Automatic" object is set to 'active' in depending on polarity. A reaction at the output occurs, however, only after a new change of state ("0"-> "1" or "1" -> "0") has been signalled via the "Sunshine / shading facade" object. In this case, the new information about the sunshine conditions (beginning of sunshine/shading or end of sunshine/shading) determines the behaviour of the output directly depending on the preset polarity.
After an ETS programming operation or after switch-on of the supply voltage, the object "Automatic" must at first have data written into it by the bus also in case of inverted polarity before the automatic operation can be activated.
The reception of an 'automatic mode deactivated' telegram by the "Automatic" object always terminates an automatic operation independent of the state of the "Sunshine / shading facade" object.

Application example:

An office building is equipped with several blinds to shade individual offices against sunlight. In the early morning hours, the automatic sun protection is activated in a central place in the building, e.g. in the porter's lodge. The blinds will, however, not move into the shading positions unless the system has actually reported sunshine for the building facades in question.

The behaviour at the end of automatic operation is configured separately in the ETS and is executed whenever the automatic mode is terminated and when no function with a higher priority is active at this time. In this situation, the curtain can move to an end position, be stopped or show no special reaction. Tracking of positions is possible as well.

Disabling functions of the enlarged sun protection:

In the event of the sun shading action starting immediately, the automatic operation can optionally be disabled with an additional communication object. The objects "Automatic" and "Automatic mode disable" are logically combined (AND with feedback). When disabling is activated, the automatic operation is reset and thus aborted. The output concerned will then show the behaviour at the end of automatic operation. The automatic mode can only be reactivated if the disabling object is enabled and if the "Automatic" object is updated again by writing a "1" into it. Any attempt of activating the automatic mode while a disable is active will be ignored.

Automatic operation disabling example:

An office room is equipped with blinds to shade the room against sunlight. The room is moreover equipped with a touch sensor on the wall with which the automatic operation can be activated or also deactivated. When the automatic mode is activated, the room is immediately shaded against sunlight, if necessary. Depending on the time of day or in the event of disturbing sunlight falling into the room, the persons in the room can therefore decide for themselves whether automatic shading is desired or not.

If required, the automatic sun protection is disabled in a central place of the building, for instance, in the porter's lodge. The automatic control of the blinds can then be deactivated, if servicing work is being carried out (window cleaning or similar work). After the end of disabling, for instance, at the end of the working hours, automatic operation can only be restarted if it is re-activated in any of the rooms in case of need.

In addition, also the direct operation of an output can be disabled with an independent disabling object. When disabling is active, a direct operation can – independent of the preset priority – never override a sun protection function. In this case, direct operation is non operational in other functions, too. During disabling, incoming direct operation telegrams are completely ignored (positions received via the bus can then not be tracked either).

If the disabling command is received while a travel movement initiated by direct operation is in progress, the movement will still be completely finished. Thereafter, direct operation is disabled.

Direct operation disabling example:

An office building is equipped with several blinds to shade individual offices against sunlight. During the working hours, the rooms are to be shaded automatically. Any direct operation – e.g. by means of a simple shutter touch sensor on the wall – is to be disabled during the day. For this reason, the direct operation is disabled, for instance, by the porter or by a building services management system. Cleaners must have the possibility of controlling the shutters directly only after the normal working hours. In this case, direct operation can again be centrally enabled during evening and night hours.

The disabling functions for automatic and for direct operation can also be combined so that it is possible to intervene at any time and as required by the situation in sun protection control functions.

Sunshine signal in the enlarged sun protection mode:

In the sun protection mode, the system is informed about the prevailing sunshine conditions via the "Sunshine / shading facade" communication object. The system then decides whether shading is required or not. In the enlarged sun protection mode, the sunshine signal is only evaluated when the automatic operation is activated as well.

A new value received via the "Sunshine / shading facade" object can optionally be evaluated with a time delay. This feature permits suppressing brief brightness variations caused, for instance, by passing clouds or by a thunderstorm. The time delay is started after an update of the "Sunshine / shading facade" object also in those cases where the automatic operation is deactivated so that the newly received information about the sunshine conditions may possibly also be processed with a delay, if the automatic operation is activated later on.

Unlike in the simple sun protection mode, an update of the "Sunshine / shading facade" object from active to active or from inactive to inactive in the enlarged sun protection mode shows generally no reaction. The behaviour of the output is only influenced if a change of state is detected. An update of the sunshine signal alone does not result in the activation of the automatic operation either.

When the automatic operation is active, the reaction of a specific output at the beginning of shading can be preset separately in the ETS. This setting permits, among other things, approaching fixed parameterized positions or positions preset via the bus and thus variable. Positions for sun protection purposes can be variably preset, for instance, by means of a weather station for sun position tracking.

In addition, it is possible in case of a defined sun protection positioning movement to have a reference travel executed by forced control. This ensures that identical curtain positions are approached synchronously by different outputs in case of a sun protection positioning movement. The reaction of an output at the end of shading with active automatic operation is also separately parameterizable. In this case, too, it is possible, among other things, to approach fixed parameterized positions.

By means of a priority setting in the ETS parameters it can be specified whether the evaluation of the sunshine signal in the automatic mode can be influenced by a direct operation or whether the automatic mode basically locks the corresponding output during sun protection. The "Manual control", "Forced position" and "Safety" functions invariably have a higher priority so that these functions can override, but not terminate a sun protection including an automatic operation. Thus, the sun protection behaviour is re-executed at the end of a function with a higher priority, if the automatic sun protection continues to be active.

An update (from activated to activated) of the "Automatic" object causes the sun protection to be reactivated, if it had been influenced or aborted beforehand by a direct operation because of its lower priority.

The schematic diagram of the enlarged sun protection (see picture 40) and an example of how sensor components can be integrated into an enlarged sun protection configuration.

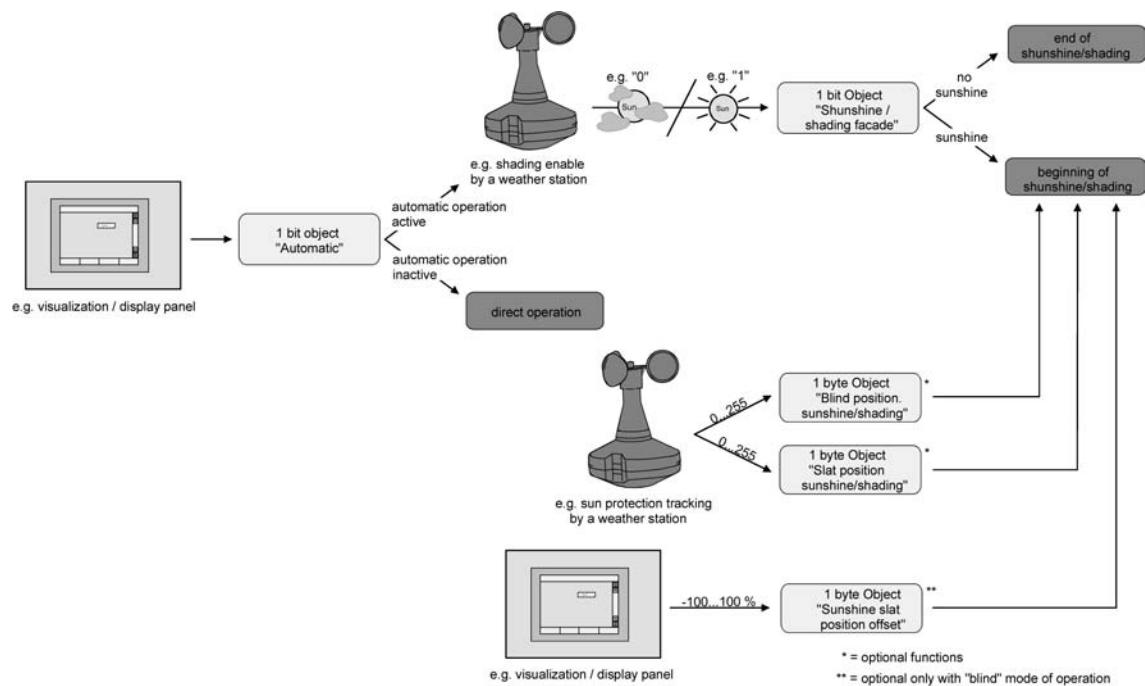

picture 40: Schematic diagram of the enlarged sun protection (for reasons of simplicity without disabling functions)

The function diagram (see picture 41) shows all possible functions of the enlarged sun protection. For reasons of clarity, the functions with a higher priority (manual control, forced position, safety function) are not shown in the diagram.

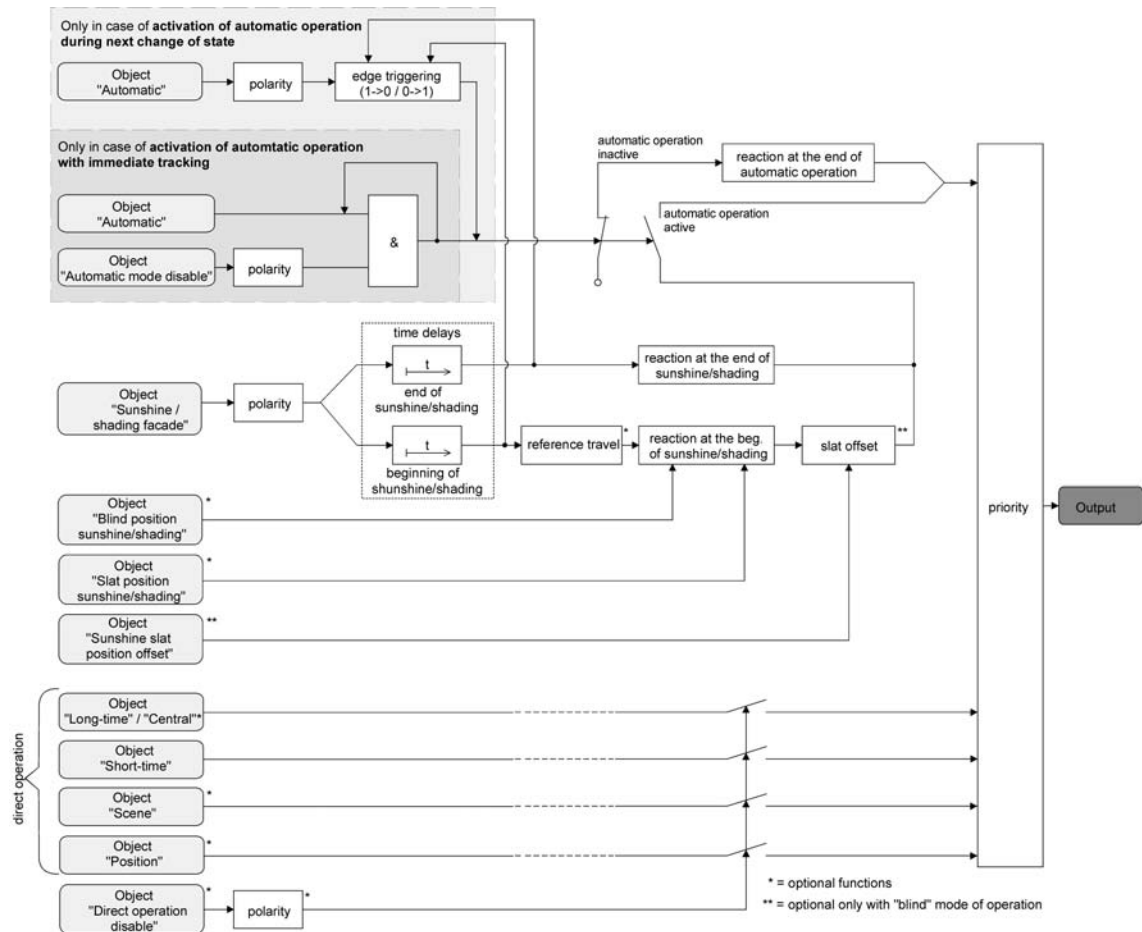

picture 41: Function diagram illustrating the enlarged sun protection

- i** The following rules must be observed for the enlarged sun protection:
- After an ETS programming operation, the sun protection function including automatic operation is always deactivated. An activated sun protection (independent of the selected priority with respect to direct operation) remains active even after a bus voltage failure as long as the mains voltage supply is still on. The sun protection reaction last executed will therefore be executed again at the end of a temporary or permanent manual control (if enabled in case of bus failure), even if there is no bus voltage.

Presetting the type of sun protection

The type of sun protection can be preset separately for each output. The setting determines whether the simple or the enlarged type of sun protection is configured.

For the sun protection parameters to be visible, the sun protection function must be enabled on the parameter page "Ax – Enabled functions (x = number pair of the output).

- Set the parameter "Type of sun protection" on parameter page "Ax – Sun protection" to "simple sun protection".

Simple sun protection is now configured. The necessary parameters and communication objects are visible.

- Set the parameter "Type of sun protection" on parameter page "Ax – Sun protection" to "enlarged sun protection".

Enlarged sun protection is now configured. The necessary parameters and communication objects are visible.

- i** When the sun protection type parameters are changed, the assignments of group addresses to sun protection objects or other parameter settings are lost. For this reason, the sun protection type parameter should be selected directly at the beginning of the sun protection parameterization and then not be changed anymore later on.

Presetting the priority of sun protection (for simple sun protection only)

The priority of the sun protection function can be set separately for each output. In the simple sun protection, the priority relations between the "Sunshine / shading facade" object and the objects of direct operation (STEP, MOVE, central or position telegram, scene recall) must be configured.

For the sun protection parameters to be visible, the sun protection function must be enabled on the parameter page "Ax – Enabled functions (x = number pair of the output).

The function must have been configured for simple sun protection.

- Set the parameter "Priority of sun protection with respect to direct operation" on parameter page "Ax Sun protection" to "same priority".

The sun protection mode can be overridden at any time by direct operation. In the same way, the sun protection overrides the direct operation if a new "sunshine" telegram is received via the "Sunshine / shading facade" object and when a parameterized time delay, if any, has elapsed. If the sun protection function is overridden by a direct operation, the preset behaviour "Reaction at the end of sunshine / shading" will not be executed.

- Set the parameter "Priority of sun protection with respect to direct operation" on parameter page "Ax Sun protection" to "higher priority".

An active sun protection will override a direct operation. The sun protection mode can therefore not be interrupted by a direct operation. Direct operation will be possible again only after the sun protection function is terminated.

- Set the parameter "Priority of sun protection with respect to direct operation" on parameter page "Ax Sun protection" to "lower priority".

A direct operation can at any time override the sun protection mode. If the sun protection function is overridden by a direct operation, the preset behaviour "Reaction at the end of sunshine / shading" will not be executed. The sun protection function can only be reactivated after an enabling movement controlled by a direct operation has been effected and after a new "sunshine" telegram has been received via the "Sunshine / shading facade" object. If the enabling movement has not yet occurred, any attempt to activate the sun protection will be disregarded.

Enabling movement:

An enabling movement is an accomplished MOVE operation into the upper end position which has been initiated by the objects "MOVE operation" or "Central travel control". A manual control, an upward travel movement after bus voltage failure or bus voltage return, a position approach to "0 %" or an upward travel movement after termination of forced-position or safety functions have no enabling effect.

The sun protection is not enabled if the enabling movement has been interrupted. The sun protection function will also be disabled if the output has been re-adjusted again by a direct operation after an accomplished enabling movement.

After an ETS programming operation or after switch-on of the supply voltage (bus and mains voltage) the sun protection function is generally enabled.

- i** Manual local operation on the device itself, the forced position function and the safety functions have a fixed priority higher than that of the sun protection. The sun protection is overridden – but not terminated – by a function with a higher priority. After the end of the function with the higher priority the reaction at the beginning of sun protection will therefore be executed again, if the sun protection is still active at this time.
- i** With the settings "same priority" or "lower priority", the sun protection can be overridden by a direct operation only if the direct control action can be executed at once. A direct operation will therefore not override the sun protection during a manual control locally on the device, an active forced position function or an active safety function.

- i** Parameter setting "same priority" or "lower priority": A variable preset of curtain and slat positions or of a slat offset via the bus at the beginning of sunshine / shading shows no reaction at the output, if the sun protection was overridden by direct operation. However, the position data or offsets received are stored internally so that the new positions will be approached on reactivation of the sun protection.

Presetting the priority of automatic sun protection (for enlarged sun protection only)

The priority of the automatic sun protection function can be set separately for each output. In the enlarged sun protection, the priority relations between the "Sunshine / shading facade" object and the objects of direct operation (STEP, MOVE, central or position telegram, scene recall) must be configured. The selected priority thus affects the evaluation of the sunshine signal in the automatic mode and not the automatic mode itself.

For the sun protection parameters to be visible, the sun protection function must be enabled on the parameter page "Ax – Enabled functions (x = number pair of the output).

The function must have been configured for enlarged sun protection.

- Set the parameter "Priority of automatic operation with respect to direct operation" on parameter page "Ax Sun protection" to "same priority".

The sunshine signal of the automatic sun protection mode and the corresponding reaction can be overridden at any time by direct operation. In the same way, the sunshine signal overrides the direct operation, when a new "sunshine" or "no sunshine" telegram is received via the "Sunshine / shading facade" object and when this telegram results in a change of state. Moreover, a parameterized delay time, if any, must have elapsed. When the sunshine signal is overridden by a direct operation, the preset behaviour "Reaction at the end of sunshine / shading" will not be executed.

- Set the parameter "Priority of automatic operation with respect to direct operation" on parameter page "Ax Sun protection" to "higher priority".

An active automatic mode always overrides the direct operation independent of the sunshine signal. The sunshine signal can therefore not be interrupted by a direct operation. Direct operation will be possible again only after the automatic mode is terminated.

- Set the parameter "Priority of automatic operation with respect to direct operation" on parameter page "Ax Sun protection" to "lower priority".

A direct operation can at any time override the sunshine signal. If the sunshine signal is overridden, the preset behaviour "Reaction at the end of sunshine / shading" will not be executed. The sunshine signal will be evaluated again only after an enabling movement controlled by a direct operation has been effected and when a new "sunshine" or "no sunshine" telegram is received via the "Sunshine / shading facade" object and when this telegram results in a change of state. The sunshine signal is ignored until the enabling movement is accomplished.

Enabling movement:

An enabling movement is an accomplished MOVE operation into the upper end position which has been initiated by the objects "MOVE operation" or "Central travel control". A manual control, an upward travel movement after bus voltage failure or bus voltage return, a position approach to "0 %" or an upward travel movement after termination of forced-position or safety functions have no enabling effect.

The sunshine signal is not enabled if the enabling movement has been interrupted. The sunshine signal will be also be interlocked, if the output has been re-adjusted again by a direct operation after an accomplished enabling movement.

- i** A direct operation never terminates the automatic mode. Irrespective of a function being overridden by a direct operation, an activation or a deactivation of the automatic mode (telegram update of the "Automatic" object) always re-enables the sunshine signal as well and evaluates it when the automatic mode is active. Attention must be paid to this behaviour especially in those cases where the "Automatic" object is cyclically overwritten by telegrams.

- i** Manual local operation on the device, the forced position function and the safety functions have a fixed priority higher than that of the automatic sun protection. The sun protection is overridden – but not terminated – by a function with a higher priority. After the end of the function with the higher priority the reaction last executed by the automatic sun protection will therefore be executed again, if the sun protection is still active at this time.
- i** With the settings "same priority" or "lower priority", the sunshine signal can be overridden by a direct operation only if the direct control action can be executed at once. A direct operation will therefore not override the sunshine signal during a manual control locally on the device, an active forced position function or an active safety function.
- i** Parameter setting "same priority" or "lower priority": A variable preset of curtain and slat positions or of a slat offset via the bus at the beginning of sunshine / shading shows no reaction at the output, if the sunshine signal was overridden by direct operation. However, the position data or offsets received are stored internally so that the new positions can be approached when the sensor signals that the sun is shining again.
- i** Irrespective of the preset priority, an update of the "Sunshine / shading facade" object from active to active or from inactive to inactive in the enlarged sun protection mode shows generally no reaction. The behaviour of the output is only influenced if a change of state is detected.

Presetting the polarity of the "Sunshine / shading facade" object

The telegram polarity of the "Sunshine / shading facade" object can be preset separately for each output. This means that an adaptation to the signals from existing sensors or weather stations is possible in the simple and also in the enlarged sun protection mode.

For the sun protection parameters to be visible, the sun protection function must be enabled on the parameter page "Ax – Enabled functions (x = number pair of the output).

- Set the parameter "Polarity of 'Sunshine / shading facade' object" on parameter page "Ax Sun protection" to the required telegram polarity.

The sunshine signal is evaluated in accordance with the preset priority.

- i** In the simple sun protection mode, an update (from activated to activated) of the "Sunshine / shading facade" object causes the sun protection to be reactivated, if it had been influenced and possibly been re-enabled beforehand by a direct operation in acc. with the preset priority.
- i** In the enlarged sun protection mode, an update of the "Sunshine / shading facade" object from active to active or from inactive to inactive shows generally no reaction. The behaviour of the output is only influenced if a change of state is detected.

Presetting the activation of the automatic mode (for enlarged sun protection only)

As far as the activation of the automatic mode is concerned, two cases must be distinguished which can be configured with the help of ETS parameters separately for each output. Either a travel movement in acc. with the reaction at the beginning or the end of sunshine is executed immediately on activation of the automatic mode, or otherwise the system waits after activation of the automatic mode for a new change of state in the "Sunshine / shading facade" object until the corresponding output shows the reaction at the beginning or at the end of sunshine.

For the sun protection parameters to be visible, the sun protection function must be enabled on the parameter page "Ax – Enabled functions (x = number pair of the output).

The function must have been configured for enlarged sun protection.

- Set the parameter "Activation of automatic mode by..." on parameter page "Ax Sun protection" to "object 'Automatic' and next change of state".

Automatic operation is activated as soon as the "Automatic" object is set to 'active' depending on polarity. A reaction at the output occurs, however, only after a new change of state has been signalled via the "Sunshine / shading facade" object. In this case, the new state (beginning of sunshine/shading or end of sunshine/shading) determines the behaviour of the output.

- Set the parameter "Activation of automatic mode by..." on parameter page "Ax Sun protection" to "object 'Automatic' & immediate tracking".

Automatic operation is activated as soon as the object "Automatic" receives a "1" telegram. The behaviour of the output (beginning of sunshine/shading or end of sunshine/shading) is immediately determined by the state of the object "Sunshine / shading facade".

- i** Various object numbers are created in the ETS for the "Automatic" object, depending on the setting. In case of re-parameterization the assignments of group addresses to the automatic object is lost.

Presetting the polarity of the "Automatic" object (for enlarged sun protection only)

If the automatic mode is to be activated via the object and only at the next change of state of the sunshine signal (see "Presetting the activation of the automatic mode"), the telegram polarity of the automatic object can be preset in addition.

For the sun protection parameters to be visible, the sun protection function must be enabled on the parameter page "Ax – Enabled functions (x = number pair of the output).

The enlarged sun protection must be configured for activation of the automatic mode on next change of state.

- Set the parameter "Polarity of 'Automatic' object" on parameter page "Ax Sun protection" to the required telegram polarity.

The telegram to the "Automatic" object will be evaluated depending on the selected priority.

- i** After an ETS programming operation or after switch-on of the supply voltage, the object "Automatic" must at first have data written into it by the bus also in case of inverted polarity before the automatic operation can be activated.
- i** The polarity of the "automatic" object is not presettable if the automatic mode is activated via the object with immediate tracking. In this case, the telegram polarity is fixed: Automatic ON = "1", Automatic OFF = "0".

Presetting the disabling function for the automatic mode (for enlarged sun protection only)

The automatic mode can be deactivated at any time via a separate disabling object. After enabling of the disabling function in the ETS parameters, the "Automatic mode disable" object becomes visible.

For the sun protection parameters to be visible, the sun protection function must be enabled on the parameter page "Ax – Enabled functions (x = number pair of the output).

The enlarged sun protection must be configured for activation of the automatic mode with immediate tracking of the sunshine signal.

- Set the parameter "Disabling function for automatic mode ?" on parameter page "Ax Sun protection" to "yes".

The disabling function is enabled. The parameter for setting of the polarity becomes visible.

- Set the parameter "Polarity of object 'Automatic mode disable'" on parameter page "Ax Sun protection" to the required telegram polarity.

The telegram to the "Automatic mode disable" object will be evaluated depending on the selected priority.

- i** The objects "Automatic" and "Automatic mode disable" are logically combined (AND with feedback). When disabling is activated, the automatic operation is reset and thus aborted. The output concerned will then show the behaviour at the end of automatic operation. The automatic mode can only be reactivated if the disabling object is enabled and if the "Automatic" object is updated again by writing a "1" into it. Any attempt of activating the automatic mode while a disable is active will be ignored.
- i** After an ETS programming operation or after switch-on of the supply voltage, the objects "Automatic" and "Automatic mode disable" are always initialised with "0". If the disabling object works with inverted polarity (setting "disabled" = "0") the disabling function is in this case immediately active. A bus voltage failure while the mains voltage is present has no effect on the state of the disabling object.

Presetting the disabling function for direct operation (for enlarged sun protection only)

The direct mode can be deactivated at any time via a separate disabling object. After enabling of the disabling function in the ETS parameters, the "Direct operation disable" object becomes visible.

For the sun protection parameters to be visible, the sun protection function must be enabled on the parameter page "Ax – Enabled functions (x = number pair of the output)".

The function must have been configured for enlarged sun protection.

- Set the parameter "Disabling function for direct mode ?" on parameter page "Ax Sun protection" to "yes".
The disabling function is enabled. The parameter for setting of the polarity becomes visible.
- Set the parameter "Polarity of object 'Direct operation disable'" on parameter page "Ax Sun protection" to the required telegram polarity.
The telegram to the "Direct operation disable" object will be evaluated depending on the selected priority.

- i** After an ETS programming operation or after switch-on of the supply voltage, the "Automatic mode disable" object is always initialised with "0". If the disabling object works with inverted polarity (setting "disabled" = "0") the disabling function is in this case immediately active. A bus voltage failure while the mains voltage is present has no effect on the state of the disabling object.

Presetting the reaction at the end of automatic operation (for enlarged sun protection only)

When the automatic operation is being deactivated – also by the disabling function – the output concerned will show the preset reaction, if no function with a higher priority is active at the time of deactivation. The reaction at the end of automatic operation will also not be executed if the direct operation is overridden on account of priority settings by a direct operation. The reaction at the end of automatic operation is preset on parameter page "Ax – Sun protection" (x = number pair of the output). Depending on the selected mode of operation, the ETS adapts the designations of the parameter settings ("raising" ↔ "opening the louver" / "lowering" ↔ "closing the louver").

For the sun protection parameters to be visible, the sun protection function must be enabled on parameter page "Ax – Enabled functions".

The function must have been configured for enlarged sun protection.

- Set the parameter "Reaction at the end of automatic operation" to "no reaction".

At the end of automatic operation the relay of the output shows no reaction. Any travel movements still in progress at this instant will still be finished.

- Set the parameter "Reaction at the end of automatic operation" to "raising" or "opening the louver".

At the end of automatic operation, the actuator raises the curtain or opens the venting louver.

- Set the parameter "Reaction at the end of automatic operation" to "lowering" or "closing the louver".

At the end of automatic operation, the actuator lowers the curtain or closes the venting louver.

- Set the parameter "Reaction at the end of automatic operation" to "stop".

At the end of automatic operation, the actuator switches the relays of the output to the "stop" position. A travel movement, if any, will be interrupted.

- Set the parameter "Reaction at the end of automatic operation" to "position tracking".

At the end of automatic operation, the output will be set to the state last adjusted statically before the automatic sun protection or to the state tracked and internally stored during the automatic sun protection. The position objects, the MOVE object and the scene function are tracked.

- i** The behaviour preset in this parameter will only be executed, if no function with a higher priority (e.g. safety) is activated at the end of automatic operation.
- i** Parameter setting "position tracking": The actuator can track absolute positions (position telegram, scene value) at the end of automatic operation only if the position data are known and if the positions have been predefined. Otherwise no reaction is shown at the end of automatic operation.
Position data can be tracked if the output was in a defined position before the automatic sun protection function or if a new position telegram was received via the position objects during the sun protection. In the latter case, a reference travel will be executed at the end of automatic operation, if the position before or during the sun protection was unknown. Known slat positions will also be tracked as described. This is also the case, when the height of the blind is unknown.
MOVE operations (movement without a preset position) are always tracked.

Presetting a time delay for beginning and end of sunshine / shading

The telegram received via the object "Sunshine / shading facade" for activation or deactivation of shading (depending on polarity) can be evaluated with a time delay separately for each output. The preset delay times are always evaluated in the simple as well as in the enlarged sun protection mode.

For the sun protection parameters to be visible, the sun protection function must be enabled on the parameter page "Ax – Enabled functions (x = number pair of the output)".

- Set the parameter "Time delay at the beginning of sunshine / shading" on parameter page "Ax – Beginning of sun protection" to the required delay time.

The telegram for activation of the sun protection will be evaluated with a delay corresponding to the setting.

- Set the parameter "Time delay at the end of sunshine / shading" to the required delay time.

The telegram for deactivation of the sun protection will be evaluated with a delay corresponding to the setting.

- i** A time setting of "0" in the parameters deactivates the respective delay time. In this case, the state of the sunshine signal is evaluated immediately.

- i** Simple sun protection mode: An update (from activated to activated) of the "Sunshine / shading facade" object causes the sun protection to be reactivated taking into account the delay time, if the sun protection had been influenced or aborted beforehand by a direct operation because of the same or a lower priority.
- i** Enlarged sun protection mode: The time delay is started after an update of the "Sunshine / shading facade" object also in those cases where the automatic operation is deactivated so that the newly received information about the sunshine conditions may possibly also be processed with a delay, if the automatic operation is activated later on. Unlike in the simple sun protection mode, an update of the "Sunshine / shading facade" object from active to active or from inactive to inactive in the enlarged sun protection mode shows generally no reaction. The behaviour of the output is only influenced if a change of state is detected. An update of the sunshine signal alone does not result in the activation of the automatic operation either.

Presetting the reaction at the beginning of sunshine / shading

The behaviour of the output at the beginning of sunshine / shading – if applicable, after the end of the delay time – can be configured in the ETS separately for each output. In the simple sun protection mode, the behaviour will be executed, when the sun protection function is activated after receiving a new sunshine signal. In the enlarged sun protection mode, the output shows the parameterized reaction, when automatic operation is activated and when a new sunshine signal ("sun is shining") is being received or was received beforehand. The reaction will not be executed if a function with a higher priority is active at the time new sunshine signal is received. The reaction at the beginning of sunshine / shading is preset on parameter page "Ax – Beginning of sun protection" (x = number pair of the output). Depending on the selected mode of operation, the ETS adapts the designations of the parameter settings ("raising" ↔ "opening the louver" / "lowering" ↔ "closing the louver"). The ETS equally adapts the parameter selection depending on the preset mode of operation.

For the sun protection parameters to be visible, the sun protection function must be enabled on parameter page "Ax – Enabled functions".

- Set the parameter "Reaction at the beginning of sunshine / shading" to "no reaction".
At the beginning of shading, the output switches over to sun protection while the relays of the output show no reaction. Any travel movements still in progress at this instant will still be finished.
- Set the parameter "Reaction at the beginning of sunshine / shading" to "raising" or "opening the louver".
At the beginning of shading, the actuator raises the curtain or opens the venting louver.
- Set the parameter "Reaction at the beginning of sunshine / shading" to "lowering" or "closing the louver".
At the beginning of shading, the actuator lowers the curtain or closes the venting louver.
- Set the parameter "Reaction at the beginning of sunshine / shading" to "stop".
At the beginning of shading, the actuator switches the relays of the output to the "stop" position. A travel movement, if any, will be interrupted.
- Set the parameter "Reaction at the beginning of sunshine / shading" to "internal scene recall". The number of the scene to be recalled must be specified in the parameter "Scene number (1...8)".
At the beginning of shading, the actuator recalls the position value preset in the scene configuration for the output concerned. This is not a scene recall as in direct operation, but only an approach to the corresponding scene position value.
- Set the parameter "Reaction at the beginning of sunshine / shading" to "fixed position".
At the beginning of shading, the actuator recalls a fixed position value for the output concerned.

- i** In the "Blind" mode of operation, the setting "fixed position" can be selected separately for the height of the blind and for the slat position. For this reason, the ETS adapts the parameter selection and enlarges the setting options in this mode of operation.
- "Fixed position" only: Set the parameter "Fixed position of blind", "Fixed position of shutter/awning" or "Fixed position of venting louver" to "as specified by parameter". Thereafter, set the parameter "Position of blind (0...100%)", "Position of shutter/awning (0...100%)" or "Venting louver position (0...100%)" to the desired position value.
At the beginning of shading, the output invariably approaches the parameterized position value.
 - "Fixed position" only: Set the parameter "Fixed position of blind", "Fixed position of shutter/awning" or "Fixed position of venting louver" to "no change of current position".
At the beginning of shading, the last adjusted height of the blind, of the shutter, of the awning or of the venting louver will be maintained.
 - "Fixed position" and mode of operation = "blind" only: Set the parameter "Fixed position of slat (0...100%)" to the desired position value.
At the beginning of shading, the output invariably moves the slats to the parameterized position after the height of the blind has been adjusted.
 - Set the parameter "Reaction at the beginning of sunshine / shading" to "variable position".
At the beginning of shading, the actuator recalls the variable position value for the output concerned. The variable presetting of the height of the blind, the shutter, awning or venting louver position takes place via the separate communication object "Sunsh./shading position" (in the "Blind" mode of operation for the slats also via the separate object "Sunsh./shading slat position").
- i** In the "Blind" mode of operation, the "variable position" setting can be selected separately for the height of the blind and for the slat position. For this reason, the ETS adapts the parameter selection and enlarges the setting options in this mode of operation.
- i** The behaviour preset in this parameter will only be executed if no function with a higher priority (e.g. safety) is activated at the time of shading.
- i** "Internal scene recall" setting: For this setting, the scene function of the output must be enabled in the ETS. Otherwise, the positions approached at the beginning of sunshine/shading are undefined positions. The scene position values stored in the actuator by a scene storage function will be approached as well. A delay configured for scene recalls has no influence on the recall of the scene value by the sun protection function.
- i** "Variable position" setting: After an ETS programming operation or after switch-on of the supply voltage, the objects "Sunsh./shading ... position" and "Sunsh./shading slat position" must receive position values from the bus. Otherwise, the actuator makes no positioning attempts at the beginning of sunshine/shading as it has no valid position data.
When the actuator is in operation, the position data can be updated at any time via the bus even if the sun protection is active (e.g. by a weather station for the purpose of sun position tracking). The actuator will then immediately approach the newly received positions if the sun protection is active. If a function with a higher priority is active, the actuator stores the newly received position values and approaches them during a later shading operation.
The position data last received are not lost in a bus voltage failure (mains voltage on).

Presetting a forced reference travel in the sun protection mode

If needed, a reference travel can be executed by forced control in the simple and in the enlarged sun protection mode at the beginning of a shading cycle, if fixed or variable position values or scene positions are to be approached. The execution of a reference travel by forced control at the beginning of shading can be used in a sun protection positioning operation to ensure

that the curtains or slats are moved synchronously by different outputs to identical positions (e.g. in a long row of windows). Without the execution of reference travel by forced control, there might otherwise be positioning inaccuracies with a negative effect on the overall appearance of a building facade with the blinds let down.

A reference travel by forced control will always be executed in the simple sun protection mode, when the beginning of shading is signalled for the first time via the

"Sunshine/shading facade" object. Updates of the object from 'sun is shining' to 'sun is shining' do not initiate a reference travel if the output is still in the sun protection position at this time.

A reference travel by forced control will be executed in the enlarged sun protection mode when the automatic mode is active or is being activated and when the beginning of shading has been signalled via the "Sunshine / shading facade" object. Updates of the object from 'sun is shining' to 'sun is shining' will never initiate a reference travel. In this case, the sunshine signal must first change from 'sun is not shining' to 'sun is shining' before a new reference travel can take place.

A reference travel by forced control will always be executed for synchronization purposes as described and also in such cases where the position data of the curtain or the slats are known. No reference travel by forced control will be executed at the end of shading.

For the sun protection parameters to be visible, the sun protection function must be enabled on the parameter page "Ax – Enabled functions (x = number pair of the output).

- Set the parameter "Reference travel before every sun protection positioning operation ?" on parameter page "Ax Beginning of sun protection" to "yes".

At the beginning of shading there is always a reference travel by forced control as described. The preset position will be approached after the end of the reference travel.

- Set the parameter "Reference travel before every sun protection positioning operation ?" on parameter page "Ax Beginning of sun protection" (x = number of output) to "no".

A reference travel at the beginning of sun protection will only be executed, if the position data are unknown, for instance, after an ETS programming operation or after switch-on of the power supply. In all other cases, the preset shading position will be approached immediately.

- i** A reference travel is the time required for a travel movement into the upper end position increased by 20 % and additionally by the parameterized travelling time extension. A reference travel is not retriggerable.
- i** Variable position preset: No reference travel will be executed, if new position values are preset via the bus while the sun protection is active.
- i** "Blind" mode of operation: A terminated reference travel of for the height of the blind synchronizes at the same time also the slat position.

Slat offset in the sun protection mode (only "Blind" mode of operation)

For the slat position at the beginning of shading, an offset can be specified separately for each output, if fixed or variable slat positions are to be approached.

If necessary, the slat offset can correct the fixed or variable nominal slat position and thus allow the creation of an individual shading situation, when the sun protection is active. The offset can be preset in two ways...

- The slat offset can be parameterized statically in the ETS. The parameterization of a static offset value allows variation of the degree of shading in those parts of the building that are not exposed to full sunshine due to objects in front of the building. The variable slat angle adjusted by the sun protection control or the fixed angle specified in a parameter can thus be overridden so that the slats are always opened a bit wider than originally preset. Alternatively, the slats can also be closed completely by means of the static offset if too much sunlight is reflected into the room.
- The slat offset can additionally be adapted by the bus via the separate communication object "Sunshine slat position offset". In this way, the desired slat offset can also be adjusted during an active shading cycle and independent of a direct operation as, for instance, the STEP mode. Thus, it is possible, for instance, that persons in a room can correct the slat angle at any time 'manually' and individually by selecting another preset value at a touch sensor or a visualization. An offset preset via the object overwrites the value parameterized in the ETS.

The preset offset is taken into account in the simple and in the enlarged sun protection mode for each positioning move during an active shading cycle (beginning of sunshine/shading) and added to the predefined nominal slat position. The offset value can be varied within a range from -100 % ... 0 ... 100 % so that the slats can be moved in both directions into the respective end positions (see picture 42). At an offset of "0 %", the actual slat position is always identical to the predefined nominal slat position for sun protection purposes.

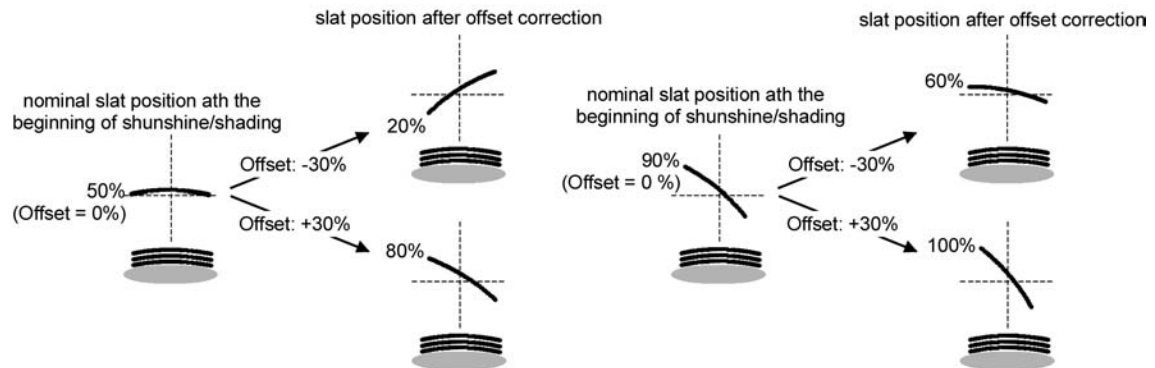

picture 42: Functional principle of slat offset
(typical of slat type 1; analogous reaction for slat type 2)

The position value actually adjusted with the offset after adding the slat position value is always between 0 and 100 %. Minimum and maximum position are thus determined by the slat end positions. These limits cannot be exceeded by specifying an greater offset. Example (see picture 42)...

Slat position at the beginning of sunshine / shading = 90 %

Slat position at the beginning of sunshine / shading = +30 %

-> The resulting slat position is 100%, as the end position has been reached.

In acc. with the KNX datapoint type 6.001 (DPT_Percent_V8), the data format of the communication object "Sunshine slat position offset" permits presetting positive and negative values in a range of 128 ... 0 ... +127. The actuator interprets the value received directly as an offset in %. Values below 100 or above +100 are limited to the minimum (-100 %) and maximum offset (+100 %) and evaluated accordingly.

An offset preset via the object overwrites the value parameterized in the ETS. In the event of a bus voltage failure or a mains voltage failure of the actuator, an offset value received via the

communication object can be stored permanently internally so that the offset value last received is not lost even in case the complete power supply fails (bus voltage and mains voltage failure). As an alternative, the offset preset via the bus can be reset (0 %) in the event of a power supply failure with the result that the value parameterized in the ETS is again used in operation. The offset reaction preset in the event of bus or mains voltage failure can be parameterized in the ETS.

Configuring the slat offset in the sun protection mode (only "Blind" mode of operation)

For the sun protection parameters to be visible, the sun protection function must be enabled on the parameter page "Ax – Enabled functions (x = number pair of the output).

The function must be configured for the "Blind" mode of operation.

The reaction at the beginning of sunshine/shading must be configured for fixed or variable position preset.

- Set the parameter "Offset with fixed and variable slat position" on parameter page "Ax Beginning of sun protection" to "no offset".

The offset correction is deactivated. During shading (beginning of sunshine/shading), the fixed or variable slat position will be approached without offset correction. The other parameters relating to the offset are blanked out.
- Set the parameter "Offset with fixed and variable slat position" to "offset as parameterized".

The static offset correction based on the parameter preset in the ETS is activated. During every shading operation (beginning of sunshine/shading), the nominal slat position is always corrected by the parameterized offset value.
- Set the parameter "Offset with fixed and variable slat position" to "offset as parameterized and via object".

The offset correction based on the parameter preset in the ETS and via the object is activated. The slat offset is preset by a fixed value parameterized in the ETS and can be adapted dynamically with a separate communication object. During every shading operation (beginning of sunshine/shading), the nominal slat position is always corrected by the preset offset value.
- Set the parameter "Slat offset position (-100 ... 100 %)" on parameter page "Ax Beginning of sun protection" to the desired offset value.

The parameterized value defines the static offset correction of the slat position. The parameterized value can be re-adjusted via the "Sunshine slat position offset" object, if the communication object has been enabled.
- Set the parameter "Store slat position offset adjusted via object in case of bus / mains voltage failure ?" to "no".

The value received via the object will only be stored temporarily in volatile memory. Thus, the value received via the object only replaces the parameterized value only until the actuator is re-initialised (return of bus or mains voltage, if both voltages were off beforehand). After the initialisation, the offset value parameterized in the ETS will be used again.
- Set the parameter "Store slat position offset adjusted via object in case of bus / mains voltage failure ?" to "yes".

The value received via the object will be stored permanently in the actuator in case of bus or mains voltage failure. The originally parameterized offset value is definitely overwritten in the process. Only a new ETS programming operation sets the offset back to the parameterized value.

- i** An offset value received via the bus is stored temporarily or permanently in the actuator and taken into account during the next shading operation. The reception of an offset value during an active shading phase (beginning of sunshine/shading active) results in an immediate and 'visible' correction of the offset angle by the output.

- i** After an ETS programming operation, the offset is always set to the value parameterized in the ETS.
- i** Storage of the slat offset position in case of bus/mains voltage failure: The offset value preset via the object is stored only if one part of the supply voltage (mains or bus) is still present or if the supply fails completely after the mains voltage has been available before without interruption for at least 20 seconds after the last reset (storage capacitors sufficiently charged for storage purposes). In all other cases nothing is stored.
- i** The slat offset has no influence on the behaviour of an output at the end of a shading phase (end of sunshine/shading).

Presetting the reaction at the end of sunshine / shading (for simple sun protection only)

At the end of the shading phase – if applicable, after the end of the delay time – the output concerned will show the preset reaction, if no function with a higher priority is active at the time of deactivation. The preset reaction will also not be executed at the end of a shading phase if the sunshine signal is overridden on account of priority settings by a direct operation.

The reaction at the end of shading is preset on parameter page "Ax End of sun protection" (x = number pair of the output). Depending on the selected mode of operation, the ETS adapts the designations of the parameter settings ("raising" ↔ "opening the louver" / "lowering" ↔ "closing the louver").

For the sun protection parameters to be visible, the sun protection function must be enabled on parameter page "Ax – Enabled functions".

The function must have been configured for simple sun protection.

- Set the parameter "Reaction at the end of sunshine / shading" to "no reaction".
At the end of shading, the relay of the output shows no reaction. Any travel movements still in progress at this instant will still be finished.
 - Set the parameter "Reaction at the end of sunshine / shading" to "raising" or "opening the louver".
At the end of shading, the actuator raises the curtain or opens the venting louver.
 - Set the parameter "Reaction at the end of sunshine / shading" to "lowering" or "closing the louver".
At the end of shading, the actuator lowers the curtain or closes the venting louver.
 - Set the parameter "Reaction at the end of sunshine / shading" to "stop".
At the end of shading, the actuator switches the relays of the output to the "stop" position. A travel movement, if any, will be interrupted.
 - Set the parameter "Reaction at the end of sunshine / shading" to "position tracking".
At the end of shading, the output will be set to the state last adjusted statically before sun protection or to the state tracked and internally stored during sun protection. The position objects, the MOVE object and the scene function are tracked.
-
- i** The behaviour preset in this parameter will only be executed if no function with a higher priority (e.g. safety) is activated when the sun protection is enabled or when a direct operation has not overridden the sunshine signal on account of priority settings.+

- i** Parameter setting "position tracking": The actuator can track absolute positions (position telegram, scene value) at the end of sun protection only if the position data are known and if the positions have been predefined. Otherwise no reaction is shown at the end of sun shading.

Position data can be tracked, if the output was in a defined position before the sun protection function or if a new position telegram was received via the positioning objects during the sun protection. In the latter case, a reference travel will be executed at the end of sun protection, if the position before or during the sun protection was unknown.

Known slat positions will also be tracked as described. This is also the case, when the height of the blind is unknown.

MOVE operations (movement without a preset position) are always tracked.

Presetting the reaction at the end of sunshine / shading (for enlarged sun protection only)

The behaviour of the output at the end of sunshine / shading – if applicable, after the end of the delay time – can be configured in the ETS separately for each output. In the enlarged sun protection mode, the output shows the parameterized reaction when automatic operation is activated and when a new sunshine signal

(change of state from "sun is shining" > "sun is not shining") is being received. The reaction will not be executed if a function with a higher priority is active at the time the sunshine signal changes. The preset reaction will also not be executed if the sunshine signal is overridden on account of priority settings by a direct operation.

The reaction at the end of sunshine / shading is preset on parameter page "Ax End of sun protection" (x = number pair of the output). Depending on the selected mode of operation, the ETS adapts the designations of the parameter settings ("raising" ↔ "opening the louver" / "lowering" ↔ "closing the louver").

For the sun protection parameters to be visible, the sun protection function must be enabled on parameter page "Ax – Enabled functions".

The function must have been configured for enlarged sun protection.

- Set the parameter "Reaction at the end of sunshine / shading" to "no reaction".
At the end of shading, the relay of the output shows no reaction. Any travel movements still in progress at this instant will still be finished.
- Set the parameter "Reaction at the end of sunshine / shading" to "raising" or "opening the louver".
At the end of shading, the actuator raises the curtain or opens the venting louver.
- Set the parameter "Reaction at the end of sunshine / shading" to "lowering" or "closing the louver".
At the end of shading, the actuator lowers the curtain or closes the venting louver.
- Set the parameter "Reaction at the end of sunshine / shading" to "stop".
At the end of shading, the actuator switches the relays of the output to the "stop" position. A travel movement, if any, will be interrupted.
- Set the parameter "Reaction at the end of sunshine / shading" to "internal scene recall".
The number of the scene to be recalled must be specified in the parameter "Scene number (1...8)".
At the end of shading, the actuator recalls the position value preset in the scene configuration for the output concerned. This is not a scene recall as in direct operation, but only an approach to the corresponding scene position value. This is not a scene recall as in direct operation, but only an approach to the corresponding scene position value.
- Set the parameter "Reaction at the end of sunshine / shading" to "fixed position".
At the end of shading, the actuator recalls a fixed position value for the output concerned.

- i** In the "Blind" mode of operation, the setting "fixed position" can only be selected in common for the height of the blind and for the slat position.

- "Fixed position" only: Set the parameter "Fixed position of blind", "Fixed position of shutter/awning" or "Fixed position of venting louver" to "as specified by parameter". Thereafter, set the parameter "Position of blind (0...100%)", "Position of shutter/awning (0...100%)" or "Position of venting louver (0...100%)" to the desired position value.
At the end of shading, the output invariably approaches the parameterized position value.
 - "Fixed position" only: Set the parameter "Fixed position of blind", "Fixed position of shutter/awning" or "Fixed position of venting louver" to "no change of current position".
At the end of shading, the last adjusted height of the blind, of the shutter, of the awning or of the venting louver will be maintained.
 - "Fixed position" and mode of operation = "blind" only: Set the parameter "Fixed position of slat (0...100%)" to the desired position value."
At the end of shading, the output invariably moves the slats to the parameterized position after the height of the blind has been adjusted.
- i** The behaviour preset in this parameter will only be executed, if no function with a higher priority (e.g. safety) is activated at the time the sunshine signal changes. The preset reaction will also not be executed if the sunshine signal is overridden on account of priority settings by a direct operation.
- i** "Internal scene recall" setting: For this setting, the scene function of the output must be enabled in the ETS. Otherwise, the positions approached at the end of sunshine/shading are undefined positions. The scene position values stored in the actuator by a scene storage function will be approached as well. A delay configured for scene recalls has no influence on the recall of the scene value by the sun protection function.

Sun protection application examples

The present chapter describes different applications of the sun protection function of the room actuator in combination with the Gira KNX / EIB weather station (order no. 1010 00) and the combination sensor (order no. 1025 00).

The applications described can be used in the simple and in the enlarged sun protection mode. For the enlarged sun protection it is important that the automatic function must be activated, if the sunshine signal of the weather station is to be evaluated and a reaction produced at the output. The optional use of the disabling functions for the automatic or for the direct operation is also possible.

For each application, the examples describe which of the communication objects of the weather station must be linked with the room actuator.

Instructions concerning the required configuration of the KNX / EIB weather station can be found in the corresponding product documentation.

- I. Sun protection with brightness limit value monitoring and fixed sun protection positions:

The limit value monitoring function of the weather station is used. The weather station transmits a "1" telegram via the "Limit value 1 [Sun...]" to the bus when a preset brightness limit value is exceeded. The room actuator activates the shading function and adjusts the curtain to the corresponding fixed sun protection position. In the "Blind" mode of operation of the room actuator, the fixed slat position specified in the parameter is recalled in addition.

When the brightness drops below the limit value for the measured brightness (with hysteresis, if programmed), the weather station transmits a "0" telegram to the bus. This deactivates the shading function in the room actuator and the corresponding reaction at the end of sunshine / shading will be executed. The communication objects must be linked according to presetting (see picture 43).

Required parameterization of the room actuator (parameters not listed are optional):

- simple or enlarged sun protection
- polarity of the "Sunshine / shading facade" object = "1" sunshine,
- reaction at the beginning of sunshine / shading = fixed positions,
- fixed positions setting.



picture 43: Programming of the communication objects for application example I

- II. Sun protection with shading control and fixed sun protection positions:

The shading control of the weather station is used. When the preset basic brightness for shading operations is exceeded, the weather station transmits a 1-bit telegram of value "1" via the "Shading facade [shading control facades 1-4]" to the bus. The room actuator activates the shading function and adjusts the curtain to the corresponding fixed sun protection position. In the "Blind" mode of operation of the room actuator, the fixed slat position specified in the parameter is recalled in addition.

When the brightness drops below the basic brightness for shading operations (with hysteresis, if programmed), the weather station transmits a "0" telegram to the bus. This deactivates the shading function in the room actuator and the corresponding reaction at the end of sunshine / shading will be executed. The communication objects must be linked according to presetting (see picture 44).

Required parameterization of the room actuator (parameters not listed are optional):

- simple or enlarged sun protection
- polarity of the "Sunshine / shading facade" object = "1" sunshine,
- reaction at the beginning of sunshine / shading = fixed positions,
- fixed positions setting.



picture 44: Programming of the communication objects for application example II

- III. Sun protection with shading control and fixed curtain height and variable slat position tracking:

The shading control of the weather station is used. The blinds connected to the room actuator are slatted blinds. When the basic brightness for shading operations is exceeded, the weather station transmits a 1-bit telegram of value "1" via the "Shading facade [shading control facade 1-4]" to the bus. The room actuator activates the shading function and adjusts the blind to the corresponding fixed sun protection position. The individual facade control of the weather station transmits additionally the slat position to be preset for sun-dependent slat tracking via the 1-byte object "Slat position (%) facade [individual facade control ...]" to the bus. The slat position required for shading will thus be adjusted in the room actuator. When the brightness drops below the basic brightness for shading operations (with hysteresis, if programmed), the weather station transmits a "0" telegram via the object "Shading facade [shading control facade 1-4]" to the bus. This deactivates the shading function in the room actuator and the corresponding reaction at the end of sunshine / shading will be executed.

Ideally, the telegram "Slat position (%) facade [individual facade control ...]" = "0 %" is suppressed in the weather station by means of a parameter. The extra slat positioning movement might otherwise adversely affect the behaviour of the output at the end of shading (possibly brief bucking).

The global disabling function of the weather station should not be used for disabling the individual facade control. Disabling can be achieved, for instance, with the disabling function of the automatic operation in the room actuator and individually for each output. The communication objects must be linked according to presetting (see picture 45).

Required parameterization of the room actuator (parameters not listed are optional):

- simple or enlarged sun protection
- polarity of the "Sunshine / shading facade" object = "1" sunshine,
- reaction at the beginning of sunshine / shading = fixed position of blind, variable position of slat,
- fixed blind position setting.

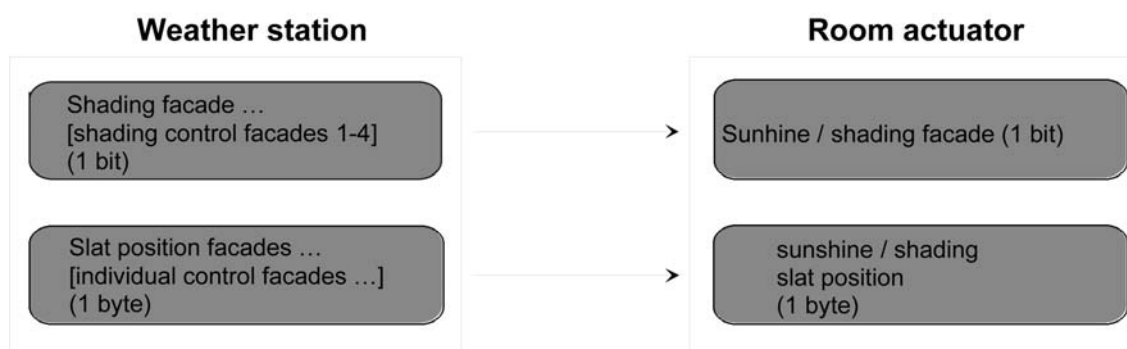

picture 45: Programming of the communication objects for application example III

- IV. Sun protection with shading control and variable curtain height and variable slat position tracking:

The shading control of the weather station is used. The blinds connected to the room actuator are slatted blinds. When the basic brightness for shading operations is exceeded, the weather station transmits a 1-bit telegram of value "1" via the "Shading facade [shading control facade 1-4]" to the bus. The shading function will thus be activated in the room actuator.

The individual facade control of the weather station transmits additionally the slat position to be preset for sun-dependent slat tracking via the 1-byte object "Slat position (%) facade [individual facade control ...]" and the blind height to be adjusted via the 1-byte object "shading facade curtain height threshold/position [individual facade control ...]" to the bus. The slat position and the blind height required for shading will thus be adjusted in the room actuator.

When the brightness drops below the basic brightness for shading operations (with hysteresis, if programmed), the weather station transmits a "0" telegram via the object "Shading facade [shading control facade 1-4]" to the bus. This deactivates the shading function in the room actuator and the corresponding reaction at the end of sunshine / shading will be executed.

Ideally, the telegrams "Slat position (%) facade [individual facade control ...]" = "0 %" and "Shading facade curtain height threshold/position [individual facade control ...]" = 0 % are suppressed in the weather station by means of a parameter. The extra blind and slat positioning movement might otherwise adversely affect the behaviour of the output at the end of shading (possibly brief bucking).

The global disabling function of the weather station should not be used for disabling the individual facade control. Disabling can be achieved, for instance, with the disabling function of the automatic operation in the room actuator and individually for each output.

The communication objects must be linked according to presetting (see picture 46).

Required parameterization of the room actuator (parameters not listed are optional):

- simple or enlarged sun protection
- polarity of the "Sunshine / shading facade" object = "1" sunshine,
- reaction at the beginning of sunshine / shading = variable position of blind, variable position of slat.

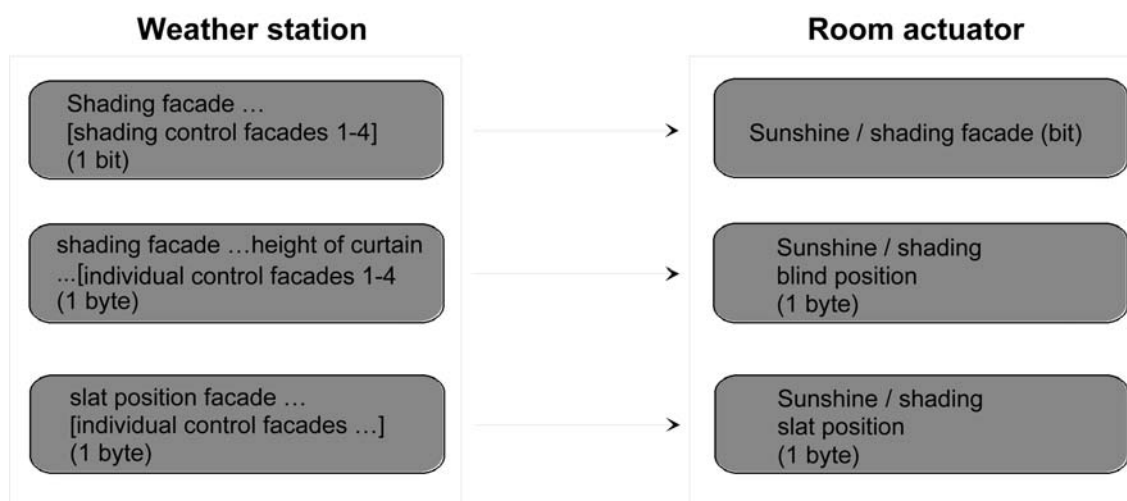

picture 46: Programming of the communication objects for application example IV

- V. Sun protection with shading control and variable curtain height and fixed slat position:

The shading control of the weather station is used. The blinds connected to the room actuator are slatted blinds. When the basic brightness for shading operations is exceeded, the weather station transmits a 1-bit telegram of value "1" via the "Shading facade [shading control facade 1-4]" to the bus. The room actuator activates the shading function and adjusts the slats to the corresponding fixed sun protection position. The individual facade control of the weather station transmits additionally the blind height to be adjusted via the 1-byte object "Shading facade curtain height threshold/position [individual facade control ...]" to the bus. The blind height required for shading will thus be adjusted in the room actuator.

When the brightness drops below the basic brightness for shading operations (with hysteresis, if programmed), the weather station transmits a "0" telegram via the object "Shading facade [shading control facade 1-4]" to the bus. This deactivates the shading function in the room actuator and the corresponding reaction at the end of sunshine / shading will be executed.

Ideally, the telegram "Shading facade curtain height threshold/position [individual facade control ...]" = 0 % is suppressed in the weather station by means of a parameter. The extra blind positioning movement might otherwise adversely affect the behaviour of the output at the end of shading (possibly brief bucking).

The global disabling function of the weather station should not be used for disabling the individual facade control. Disabling can be achieved, for instance, with the disabling function of the automatic operation in the room actuator and individually for each output. The communication objects must be linked according to presetting (see picture 47).

Required parameterization of the room actuator (parameters not listed are optional):

- simple or enlarged sun protection
- polarity of the "Sunshine / shading facade" object = "1" sunshine,
- reaction at the beginning of sunshine / shading = variable position of blind, fixed position of slat.
- fixed slat position setting.

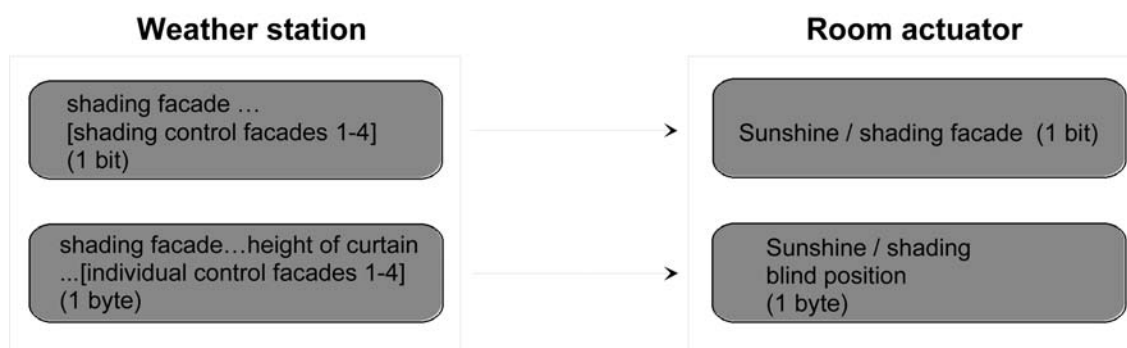

picture 47: Programming of the communication objects for application example V

Automatic heating/cooling

The automatic heating / cooling function can supplement the enlarged sun protection so that the shading function of a room can be made use of in another application.

When automatic heating / cooling is active, a presence signal – e.g. from a KNX / EIB presence monitor or a detector – is evaluated in addition to the signals of the enlarged sun protection function. The automatic sun protection function will then only be activated by the actuator when persons are in the room. Depending on the sunshine signal, the room is then protected against sunshine or not as described in the preceding chapters.

Without receiving a presence signal the actuator evaluates in addition a heating/cooling signal derived, for instance, from a room thermostat or from an outside thermostat. In this case, the shading function can be used to support the heating or cooling function in a room. As no per-

sons are present in the room, intensive sunlight can be used, for instance, to heat up the room by opening the slats or by raising the curtain. Similarly, the room can also be shaded against sunlight during the absence of persons, if additional heating up of the room is not desired.

By evaluating the three 1-bit signals "Presence", "Heating/cooling change-over" and "Sunshine / shading facade" the telegram polarity of which can be parameterized independently in the ETS, the enlarged sun protection function with automatic heating/cooling can differentiate between the 6 states shown in table 3 and the corresponding output reactions.

Presence signal	Heating/cooling change-over	Sunshine / shading facade	Reaction at output
persons present	--- (irrelevant)	sunshine signal active	reaction at the beginning of sunshine/shading
persons present	--- (irrelevant)	sunshine signal inactive	reaction at the end of sunshine/shading
no persons present	heating active	sunshine signal active	reaction at the beginning of sunshine/shading with heating
no persons present	heating active	sunshine signal inactive	reaction at the end of sunshine/shading with heating
no persons present	cooling active	sunshine signal active	Sunshine signal active reaction at the beginning of sunshine/shading with cooling
no persons present	cooling active	sunshine signal inactive	reaction at the end of sunshine/shading with cooling

Table 3: States of the enlarged sun protection function with heating/cooling change-over

As described for the enlarged sun protection without heating/cooling, the sunshine signal will be delayed, if a delay is parameterized in the ETS for this signal. In the same way, the presence signal can be independently evaluated with a time delay, too, if a debouncing effect for brief changes of the signal state is to be achieved.

The schematic diagram (see picture 48) shows the interaction of the different communication objects of the enlarged sun protection function in combination with the automatic heating/cooling function. The diagram moreover illustrates the principle of incorporating sensor components into the automatic heating/cooling function.

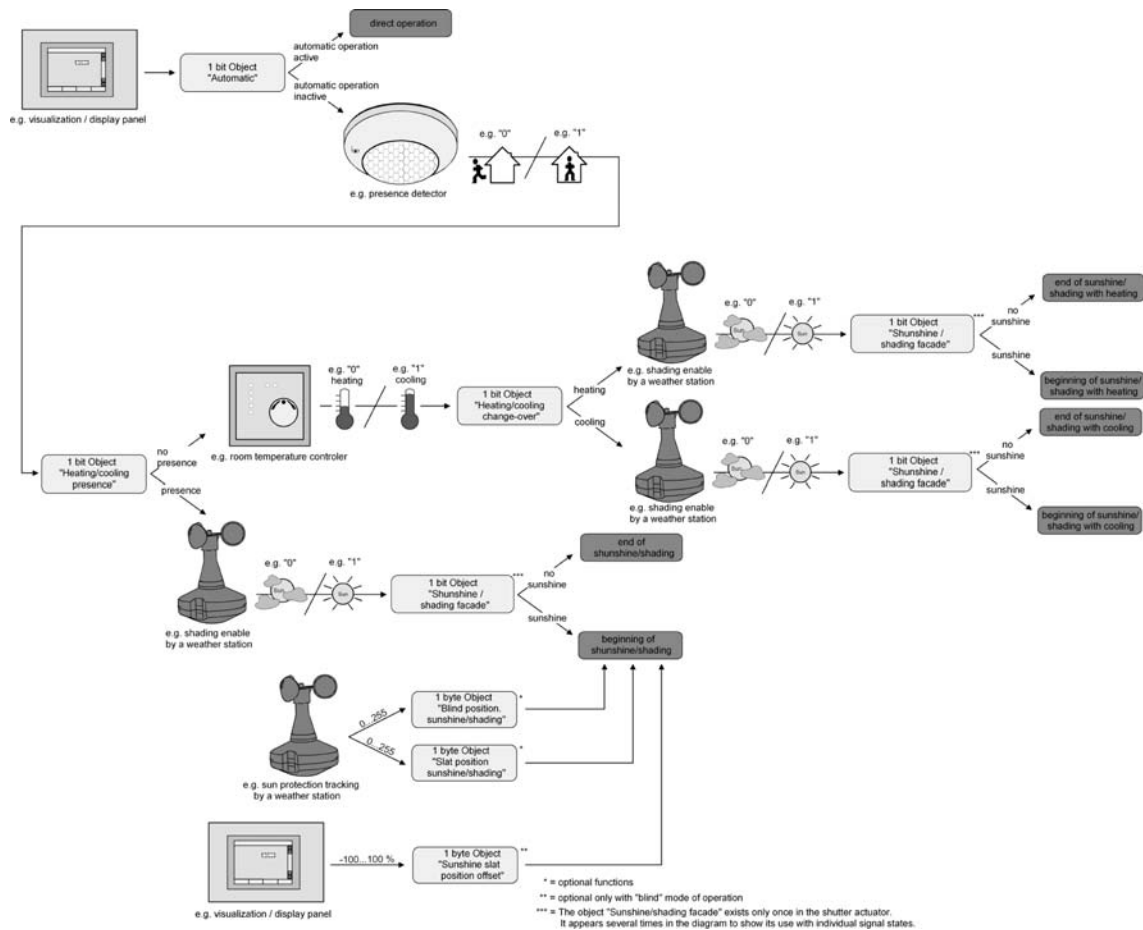

picture 48: Schematic diagram of the automatic heating/cooling function (for reasons of simplicity shown without disabling functions of the automatic or direct operation)

In accordance with the schematic diagram, the automatic heating/cooling function is only active when the automatic sun protection is active, too. Like in the enlarged sun protection mode without automatic heating/cooling, the automatic sun protection is activated via the object "Automatic" depending on the parameterization either immediately or only after a change of state has been detected for one of the signals "presence", "heating/cooling change-over" and "sunshine / shading facade" (cf. "Sun protection function – Enlarged sun protection").

After an ETS programming operation or after switch-on of the power supply of the actuator (bus and mains voltage supply), the corresponding communication objects of the signals "presence", "heating/cooling change-over" and "sunshine / shading facade" are initialised with "0". In accordance with the preset polarity, the state of the sunshine and of the presence signal as well as the heating/cooling state will be determined and the corresponding reaction executed provided the automatic sun protection function is active. When the automatic sun protection is active, any change of state of the presence signal or any change in the heating/cooling signal will be evaluated immediately and the corresponding reaction executed.

The function diagram (see picture 49) shows all possible functions of the enlarged sun protection with automatic heating/cooling. For reasons of clarity, the functions with a higher priority (manual control, forced position, safety function) are not shown in the diagram.

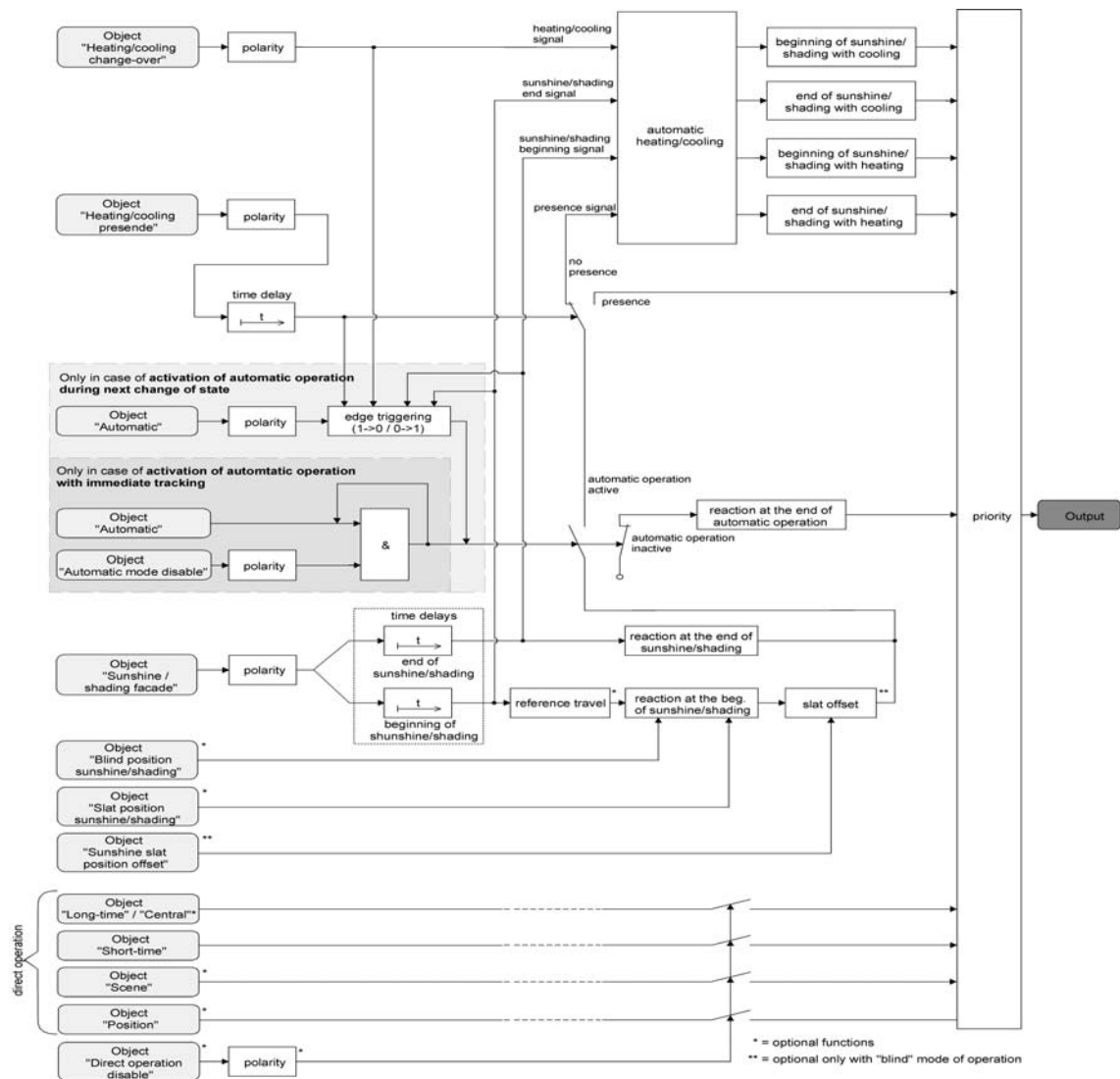

picture 49: Function diagram of automatic heating/cooling

Enabling automatic heating/cooling

Automatic heating/cooling can be preset separately for each output. When automatic heating/cooling is enabled, the enlarged sun protection function will be supplemented by the necessary communication objects and parameters.

The sun protection function must be enabled on parameter page

"Ax – Enabled functions (x = number pair of the output). Moreover, the function must have been configured for enlarged sun protection.

- Set the parameter "Automatic heating/cooling" on parameter page "Ax – Automatic heating/cooling" to "enabled".

The automatic heating/cooling function is enabled. The necessary parameters and communication objects are visible.

- Set the parameter "Automatic heating/cooling" on parameter page "Ax – Automatic heating/cooling" to "disabled".

The automatic heating/cooling function is deactivated. The corresponding parameters and objects are blanked out. Only the enlarged sun protection without evaluation of the heating/cooling and of the presence signal is now configured.

- i** If the automatic heating/cooling activation parameters are changed, the group address assignments and the parameter settings are lost. For this reason, the automatic heating/cooling parameters should be selected directly at the beginning of parameterization and then not be changed anymore later on.

Presetting the polarity of the "Heating/cooling change-over" object

The telegram polarity of the "Heating / cooling change-over" object can be preset separately for each output. This means that an adaptation to the signals from existing room thermostats or from outside thermostats is possible.

For the parameters to be visible, automatic heating/cooling must be enabled on parameter page "Ax – Automatic heating/cooling" (x = number pair of the output).

- Set the parameter "Polarity of 'Heating/cooling change-over' object" on parameter page "Ax Sun protection" to the required telegram polarity.

The heating/cooling signal is evaluated in accordance with the preset priority.

- i** An update of the "Heating / cooling change-over" object from active to active or from inactive to inactive shows generally no reaction. The behaviour of the output is only influenced if a change of state is detected.
- i** After switch-on of the power supply (bus and mains voltage) of the actuator, the heating/cooling change-over function is initialised with an object value of "0".

Presetting the polarity of the "Heating/cooling presence" object

The telegram polarity of the "Heating / cooling presence" object can be preset separately for each output. This means that an adaptation to the signals from existing KNX/EIB presence monitors or detectors is possible.

For the parameters to be visible, automatic heating/cooling must be enabled on parameter page "Ax – Automatic heating/cooling" (x = number pair of the output).

- Set the parameter "Polarity of 'Heating / cooling presence' object" to the required telegram polarity.

The presence signal is evaluated in accordance with the preset priority.

- i** An update of the "Heating / cooling presence" object from active to active or from inactive to inactive shows generally no reaction. The behaviour of the output is only influenced if a change of state is detected.
- i** After switch-on of the power supply (bus and mains voltage) of the actuator, the heating / cooling / presence control is initialised with an object value of "0".

Presetting a time delay for beginning and end of presence

The telegram received via the "Heating / cooling presence" object for transmission of the presence state (depending on polarity) can be evaluated with a time delay separately for each output.

For the parameters to be visible, automatic heating/cooling must be enabled on parameter page "Ax – Automatic heating/cooling" (x = number pair of the output).

- Set the parameter "Time delay at the beginning of presence" to the required delay time.
The telegram for activation of the presence mode will be evaluated with a delay corresponding to the setting.
- Set the parameter "Time delay at the end of presence" to the required delay time.

The telegram for deactivation of the presence mode will be evaluated with a delay corresponding to the setting.

- i** A time setting of "0" in the parameters deactivates the respective delay time. In this case, the presence state is evaluated immediately on reception of a telegram.
- i** An update of the "Heating / cooling presence" object from active to active or from inactive to inactive shows generally no reaction. The behaviour of the output is only influenced if a change of state is detected. An update of the presence signal alone does not result in the activation of automatic operation either.
- i** The time delay is started after an update of the "Heating / cooling presence" object also in those cases where the automatic operation is deactivated so that the newly received presence state may possibly also be processed with a delay, if the automatic operation is activated later on.

Presetting the reaction of automatic heating/cooling

The behaviour of the output when automatic heating/cooling is active can be configured separately for each output. The evaluation of the three 1-bit signals "Presence", "Heating/cooling change-over" and "Sunshine / shading facade" permits distinguishing four states...

- "reaction at the **beginning** of sunshine/shading with **heating**",
- "reaction at the **end** of sunshine/shading with **heating**",
- "reaction at the **beginning** of sunshine/shading with **cooling**",
- "reaction at the **end** of sunshine/shading with **cooling**".

The reaction of an output can be set in the ETS separate for each of the mentioned states. There is no difference between the parameter settings for the individual states. For this reason, the following text describes the possible configuration only in the form of an example. The reaction at the end of automatic heating/cooling operation is preset on parameter page "Ax Automatic heating/cooling" (x = number pair of the output). Depending on the selected mode of operation, the ETS adapts the designations of the parameter settings ("raising" ↔ "opening the louver" / "lowering" ↔ "closing the louver").

For the parameters to be visible, automatic heating/cooling must be enabled on parameter page "Ax – Automatic heating/cooling" (x = number of output).

- Set the parameter "Reaction at the ... of sunshine / shading" to "no reaction".
During automatic heating/cooling, the relays of the output show no reaction. Any travel movements still in progress will still be finished.
- Set the parameter "Reaction at the ... of sunshine / shading" to "raising" or "opening the louver".
During automatic heating/cooling, the actuator raises the curtain or opens the venting louver.
- Set the parameter "Reaction at the ... of sunshine / shading" to "lowering" or "closing the louver".
During automatic heating/cooling, the actuator lowers the curtain or closes the venting louver.
- Set the parameter "Reaction at the ... of sunshine / shading" to "stop".
During automatic heating/cooling, the actuator switches the relays of the output to the "stop" position. A travel movement, if any, will be interrupted.
- Set the parameter "Reaction at the ... of sunshine / shading" to "internal scene recall". The number of the scene to be recalled must be specified in the parameter "Scene number (1...8)".
During automatic heating/cooling, the actuator recalls the position value preset in the scene configuration for the output concerned. This is not a scene recall as in direct operation, but only an approach to the corresponding scene position value.
- Set the parameter "Reaction at the ... of sunshine / shading" to "fixed position".

During automatic heating/cooling, the actuator recalls a fixed position value for the output concerned.

- i** In the "Blind" mode of operation, the setting "fixed position" can only be selected in common for the height of the blind and for the slat position.
- "Fixed position" only: Set the parameter "Fixed position of blind", "Fixed position of shutter/awning" or "Fixed position of venting louver" to "as specified by parameter". Thereafter, set the parameter "Position of blind (0...100%)", "Position of shutter/awning (0...100%)" or "Position of venting louver (0...100%)" to the desired position value.
During automatic heating/cooling, the output invariably approaches the parameterized position value.
 - "Fixed position" only: Set the parameter "Fixed position of blind", "Fixed position of shutter/awning" or "Fixed position of venting louver" to "no change of current position".
During automatic heating/cooling, the position the last adjusted of the blind, of the shutter, of the awning or of the venting louver will be maintained.
 - "Fixed position" and mode of operation = "blind" only: Set the parameter "Fixed position of slat (0...100%)" to the desired position value.
During automatic heating/cooling, the output invariably moves the slats to the parameterized position after the height of the blind has been adjusted.
- i** The parameterized reactions will not be executed if a function with a higher priority is active during automatic heating/cooling (e.g. safety function, forced position or manual control). The preset reaction will also not be executed if the automatic sun protection is overridden on account of priority settings by a direct operation.
- i** "Internal scene recall" setting: For this setting, the scene function of the output must be enabled in the ETS. Otherwise, the positions approached during automatic heating/cooling are undefined positions. The scene position values stored in the actuator by a scene storage function will be approached as well. A delay configured for scene recalls has no influence on the recall of the scene value by the automatic heating/cooling function.

Scene function

An actuator can hold up to 8 scenes for each output and store scene position values for the height of a blind, shutter or awning or the position of a venting louver. In the 'Blinds' mode, the user can also preset slat positions. The scene values are recalled or stored via a separate scene extension object by means of extension telegrams. A scene recall of an output can optionally also be delayed.

The datapoint type of the extension object permits addressing a maximum of 64 scenes. Therefore the parameterization of a scene can be used to define the scene number (1...64) which is used to address the internal scene (1...8).

In order for the required communication objects and parameters (on parameter page "Ax – Scenes") to be visible, the scene function must have been enabled for each output on parameter page "Ax – Enabled functions" (x = number pair of the output).

The scene function, like the control of an output by means of STEP, MOVE, central or position telegrams, is a kind of direct operation. For this reason, a recalled scene position can at any time be overridden by a manual control, a forced position or a safety function. The scene position last recalled can also be readjusted by other telegrams of the direct operation mode. The priority of direct operation and also of the scene function can be parameterized with respect to the sun protection function (cf. "Sun protection function").

Presetting a scene recall delay for the scene function

Each scene recall of an output can optionally also be delayed. With this feature, dynamical scene sequences can be configured if several outputs are combined with cyclical scene telegrams.

The scene function must be enabled on parameter page "Ax – Enabled functions" (x = number pair of the output).

- Set the parameter "Delay scene recall?" on parameter page "Ax – Scenes" to "yes".
The delay time is now activated and can be parameterized separately. The delay only influences the scene recall of the output. The delay time is started on arrival of a recall telegram. The corresponding scene will be recalled and the output set to the respective scene position value only after this time has elapsed.
- ❗ Each scene recall telegram restarts the delay time and retriggers it. If a new scene recall telegram is received while a delay is active (scene recall not yet executed), the old (and not yet recalled scene) will be rejected and only the scene last received executed.
- ❗ The scene recall delay has no influence on the storage of scene values. A scene storage telegram within a scene recall delay terminates the delay and thus the scene recall.
- ❗ In case of bus voltage failure, all time functions will be stopped. Therefore, all scene recalls that are still in the delay stage will be aborted. A scene recall received shortly before bus voltage failure is then lost, if the corresponding delay has not yet elapsed. A delayed scene recall will also be aborted, if a function with a higher priority (manual control, forced position, safety, sun protection, if the priority is the same as or higher than that of direct operation) is activated. The scene recall is nevertheless stored internally so that the scene positions last recalled can be tracked at the end of a higher-ranking function.

Presetting the ETS download behaviour for the scene function

During storage of a scene, the scene values are stored permanently in the device (cf. "Presetting the storage behaviour for the scene function"). To prevent the stored values from being replaced during ETS programming of the application or of the parameters by the originally programmed scene position values, the actuator can inhibit overwriting of the scene values. As an alternative, the original values can be reloaded into the device during each programming run of the ETS.

The scene function must be enabled on parameter page "Ax – Enabled functions" (x = number pair of the output).

- Set the parameter "Overwrite the values stored in the device during ETS download ?" on parameter page "Ax – Scenes" to "Yes".
During each ETS programming of the application or of the parameters, the scene values parameterized in the ETS for the output concerned will be programmed into the actuator. Scene values stored in the device by means of a storage function will be overwritten, if any.
- Set the parameter "Overwrite the values values in the device during ETS download ?" on parameter page "Ax – Scenes" to "No".
Scene values stored in the device with a storage function will be maintained. If no scene values have been stored, the position values last programmed in the ETS remain valid.
- ❗ When the actuator is put into operation for the first time, this parameter should be set to "yes" so that the output is initialised with valid scene values. In the blind actuator as supplied, the scene positions are internally set to default values as in the ETS product database.

Presetting scene numbers

The datapoint type of the scene extension object permits addressing of up to 64 scenes max. For this reason, the scene number (1...8) with which the scene is addressed, i.e. recalled or stored, must be determined for each internal scene (1...64) of the output.

The scene function must be enabled on parameter page

"Ax – Enabled functions" (x = number pair of the output).

- Set the parameter "Scene y activatable by scene number" (y = number of the scene (1...8)) on parameter page "Ax – Scenes" for each scene to the numbers with which the scenes are to be addressed.

A scene can be addressed with the parameterized scene number. A setting of "0" deactivates the corresponding scene so that neither recalling nor storage is possible.

- i** If the same scene number is parameterized for several scenes, only the scene with the lowest internal scene number (1...8) will be addressed. The other internal scenes will be ignored in this case.

Presetting scene positions

Moreover, the position value (blind, shutter, awning, venting louver position) to be set for the output in case of a scene recall must be specified as well. In the "Blind" mode, the height of the blind and the slat position can be preset.

The scene function must be enabled on parameter page

"Ax – Enabled functions" (x = number pair of the output).

- Set the parameter "Position ... for scene y" (y = number of the scene (1...8)) on parameter page "Ax – Scenes" for each scene to the desired position value (0 %...100 %). In case of a scene recall, the output is set to the parameterized position.

- i** The parameterized position values are adopted in the actuator during programming with the ETS only if the parameter "Overwrite values stored in the device during ETS download ?" is set to "yes".
- i** Before approaching the required scene position, if necessary the actuator performs a reference travel, if the current position data are unknown (e.g. after an ETS programming operation or after switch-on of the supply voltage).

Presetting the storage behaviour for the scene function

The current position value of a blind, shutter, awning, venting louver and also of a slat can be stored internally via the extension object on reception of a scene storage telegram. The position value can be influenced before storage by all functions of the output (e.g. STEP and MOVE operation, central or scene recall telegram, safety and sun protection function and manual control).

The scene function must be enabled on parameter page

"Ax – Enabled functions" (x = number pair of the output).

- Set the parameter "Storage function for scene y" (y = number of the scene (1...8)) on parameter page "Ax – Scenes" for each scene to "yes".

The storage function is activated for the scene in question. On reception of a storage telegram via the "Scene extension" object, the current position value will be internally stored.

- Set the parameter "Storage function for scene y" (y = number of the scene (1...8)) on parameter page "Ax – Scenes" for each scene to "no".

The storage function is deactivated for the scene in question. A storage telegram received via the "scene extension" object will be rejected.

- i** The following rules apply for the position data to be stored:
 The current curtain, slat and louver positions are stored. With blinds, the height to be stored is always referred to a slat position of 100 %. Positions temporarily approached will be stored also for those outputs that are involved in a travel movement at the time of data storage.
 On account of the fact that position data are stored as integer percentage values (rounded to 0...100), a minor deviation from the positions reported back later during a scene recall cannot be avoided.
 The data are stored only if mains voltage has been available before without interruption for at least 20 seconds after the last reset (storage capacitors sufficiently charged for storage purposes). The data will not be stored, if the position data are unknown.

Forced position function

The forced position function can be enabled for blind output. The forced position has the second highest priority after manual control. It therefore overrides the safety function, the sun protection function and the direct operation (STEP, MOVE telegram, scenes, positioning, central). During a forced-position state, the output concerned is locked so that it can no longer be controlled with functions of a lower priority, but only with a manual control. At the end of a manual control, the forced-position action is re-executed if the forced position is still active.

The forced position function has a separate 2-bit communication object for each output. The state of the output in case of a forced position function is directly determined by the forced-position telegram. The first bit (bit 0) of the "Forced position" object specifies the travel direction to be forced onto the output as in MOVE operation. The second bit (bit 1) activates or deactivates the forced-position state (see Table 4).

Bit 1	Bit 0	Function
0	x	forced position not active normal control
0	x	forced position not active normal control
1	0	Forced position active, raising / opening the louver
1	1	Forced position active, lowering / closing the louver

Table 4: Bit coding of forced position

The behaviour of an output at the end of the forced position function can be parameterized. The forced position object can moreover be initialised on return of bus voltage. A mains failure alone (bus voltage present) has no effect on the state of the forced position object. In case of a return of only the mains voltage, a previously activated forced position remains active.

- i** The forced-position travelling time required by an output to move the drive into the end positions is determined by the "Travelling time" parameter on parameter page "Ax - Times". Like the MOVE operation, a forced-position travel is derived from the travelling time. Downward travel: travelling time + 20 %; Upward travel: travelling time + 20 % + parameterized travelling time extension. Forced-position travels are not retriggerable.
- i** The slats of blinds are not repositioned at the end of forced position travels into the end positions.
- i** Updates of the forced position object from "forced position active" to "forced position active" while maintaining the forced travel direction or from "forced position inactive" to "forced position inactive" show no reaction.
- i** After programming of the application or of the parameters with the ETS, the forced position is always cancelled.
- i** The forced position function remains active even after a bus voltage failure as long as the mains voltage supply is still on. The forced position function will therefore be executed again at the end of a temporary or permanent manual control – if enabled in case of bus failure – even if there is no bus voltage.

- i** The current state of the forced position function will be stored in case of bus or mains voltage failure.

Enabling the forced position function

The forced position function can be enabled separately for each output.

- Set the parameter "Forced position function" on parameter page "Ax – Enabled functions" (x = number pair of the output) to "enabled".

The forced position function is enabled. The corresponding communication object is created and the respective parameters on parameter page "Ax – Forced position" become visible.

Presetting the behaviour at the end of the forced position function

The behaviour of an output at the end of the forced-position function can be parameterized depending on the channel. The behaviour is parameterized on parameter page "Ax – Forced position" (x = number pair of the output).

The forced position function of an output must be enabled on parameter page "Ax – Enabled functions" (x = number of output). Only then are the channel-related parameters for the forced position function visible.

- Set the parameter "Behaviour at the end of the forced position function" to "position tracking".

At the end of a forced position function, the output will be set to the state adjusted statically before the forced position function or to the state tracked and internally stored during the forced position function. The position objects, the MOVE object and the scene function are tracked.

- Set the parameter "Behaviour at the end of the forced position function" to "no change".

At the end of forced position function, the state last adjusted will not be changed. Thereafter, the output is again enabled. Any travel movements still in progress at this instant will still be finished.

- i** Parameter setting "position tracking": The actuator can track absolute positions (position telegram, scene value) when the forced control function is terminated only if the position data are known and if positions have been predefined. Otherwise no reaction is executed at the time forced control is terminated.
Position data can be tracked if the output has been in a defined position before the forced position function or if a new position telegram has been received via the positioning objects while the forced position function was interlocked. In the latter case, a reference travel will be executed when the forced control function is terminated, if the position was unknown before or while the forced position was interlocked.
Known slat positions will also be tracked as described. This is also the case, when the height of the blind is unknown.
MOVE operations (movement without a preset position) are always tracked, however.

- i** The preset "Behaviour at the end of the forced position function" will only be executed if the output passes over to direct operation at the end of the forced position function. If a safety function or a sun protection function is activated (independent of the preset priority with respect to direct operation), the function with the next lower priority will be executed. The parameterized behaviour will not be executed either if the forced position function is terminated by a preset on return of bus voltage. In this case, the preset "Behaviour after bus/mains voltage return" will be executed.

Presetting the behaviour of the forced position function after bus voltage return

The communication object of the forced position function can be initialised after bus voltage return. In this way, an output can be influenced and interlocked on bus initialisation when the forced position function is being activated.

A mains failure alone has no effect on the forced position. In case of a return of only the mains voltage, a previously activated forced position remains active.

The behaviour after bus voltage return for the forced position is parameterized separately for each output on the parameter pages "Ax – Forced position" (x = number pair of the output). Depending on the selected mode of operation, the ETS adapts the designations of the parameter settings ("raising" ↔ "opening the louver" / "lowering" ↔ "closing the louver").

After bus voltage return the parameterized state is adopted in the communication object "Forced position".

The forced position function of an output must be enabled on parameter page "Ax – Enabled functions" (x = number of output). Only then are the channel-related parameters for the forced position function visible.

- Set the parameter "Behaviour after bus voltage return" to "no forced position active".
After bus voltage return, the forced position function is deactivated. In this case, the preset "Behaviour after bus/mains voltage return" will be executed on return of bus voltage.
- Set the parameter "Behaviour after bus voltage return" to "forced position function on, raising" or "forced position function on, opening the louver".
The forced position function is activated after bus voltage return and the curtain is raised or the venting louver opened by forced control. The output concerned is interlocked by forced control until an enable signal is received via the bus. In this case the parameter "Behaviour after bus voltage return" will not be evaluated for the output concerned.
- Set the parameter "Behaviour after bus voltage return" to "forced position function on, lowering" or "forced position function on, closing the louver".
The forced position function is activated after bus voltage return and the curtain raised or the venting louver opened by forced control. The output concerned is interlocked by forced control until an enable signal is received via the bus. In this case the parameter "Behaviour after bus/mains voltage return" will not be evaluated for the output concerned.
- Set the parameter "Behaviour after bus voltage return" to "state of forced position before bus/mains failure".
After bus voltage return, the forced position state last selected and internally stored before bus or mains voltage failure will be tracked. An ETS programming operation deletes the stored state (reaction in that case same as with "no forced position active"). If the tracked state corresponds to "no forced position active", the parameter "Behaviour after bus/mains voltage return" will be executed on return of bus voltage.

- i** Setting or tracked state "no forced position active": The reaction of the output concerned after return of bus voltage is defined by the parameter "Behaviour after bus/mains voltage return".
- i** After programming of the application or of the parameters with the ETS, the forced position is always cancelled.

'Fabric-stretching' function

In the shutter/awning mode of operation, the fabric-stretching function can be activated. The fabric-stretching function permits stretching the fabric of an awning tight after lowering. The fabric-stretching function can also be used with shutters to re-open the slits of the shutter curtain after a downward movement into the lower end position.

If activated in the ETS parameters, fabric stretching is executed during each downward travel after stopping and after the parameterized change-over delay has elapsed. The curtain is then 'stretched' by moving it briefly in the opposite travel direction (see picture 50).

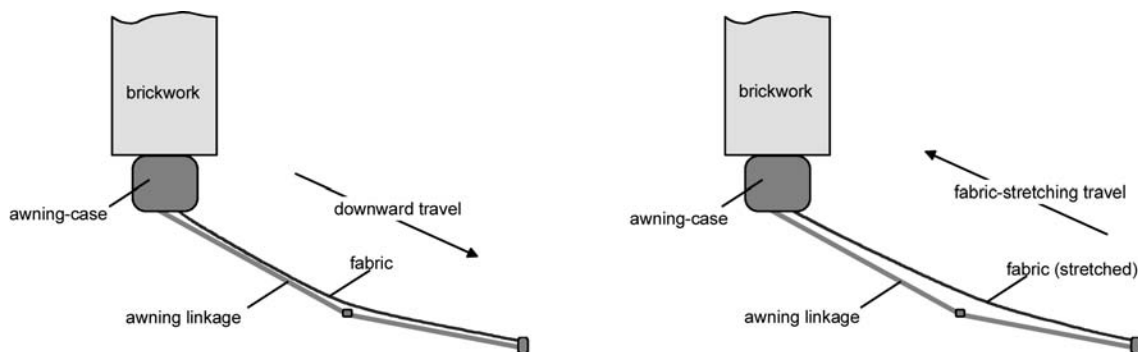

picture 50: Fabric-stretching in an awning

The downward travel can be triggered by any of the following events: MOVE, STEP, or position telegram, forced position, safety or sun protection function, central telegram or scene recall and also the manual control.

Fabric-stretching is never effected in upward travel movements.

- i Fabric stretching affects the determination of positions and the position feedback since a fabric-stretching movement changes the position of a shutter or an awning. In a positioning move into the lower end position (100 %), the position value reported back after the fabric-stretching operation will always be a smaller one.
- i Fabric-stretching cannot be parameterized in the blind or louver modes of operation.

Activating the fabric-stretching function

The fabric-stretching function can be activated independently for each shutter or awning output on parameter page "Ax – Enabled functions" (x = number pair of the output).

The mode of operation selected must be the "Shutter/awning" mode.

- Set the parameter "Fabric-stretching function" to "enabled".
Parameter page "Ax – Fabric-stretching" is enabled and the fabric-stretching function is activated.

- i Fabric-stretching cannot be parameterized in the blind or louver modes of operation.

Presetting the fabric-stretching function

The fabric-stretching function can be parameterized independently for each shutter or awning output on parameter page "Ax – Fabric-stretching" (x = number pair of the output). The travelling time required for fabric stretching by means of a movement in the opposite direction can be parameterized.

The fabric-stretching function must be activated.

- Select the desired value for the "Time for fabric-stretching" parameter.
After the end of a downward travel the curtain stops and – after elapsing of the change-over delay – moves backwards in the opposite direction for a period corresponding to the parameterized fabric-stretching time.

- i The time for fabric stretching must be selected shorter than the parameterized or measured travelling time of the shutter or awning. Otherwise, risk of malfunction.

- i** Fabric stretching will only be effected if the downward movement lasts longer than the parameterized fabric-stretching time.

4.2.4.2.3 Functional description for valve outputs

Valve direction of action

Both valve drives which are closed in the deenergized state and valve drives which are open in the deenergized state can be connected to the valve outputs of the room actuator. The direction of action of a valve drive in the deenergized state is determined by the physical structure of the drive, and is generally specified by the manufacturer of the device. In order for the room actuator to control the connected valve 'in the right direction', the valve direction of action must be configured in the ETS for each valve output.

Setting the valve direction of action

The valve direction of action can be set separately for each valve output on the parameter page "Ax - General" (x = number of the valve output).

- Set the parameter "Valve direction of action (Valve in deenergized state)" to "closed".
For switching command values the switching telegram received via the "Command value" object is forwarded directly to the corresponding output of the actuator. When an "ON" telegram is received, the output is energized, thus opening the valve completely. If an "OFF" telegram is received, the valve is closed completely by switching off the output (see picture 51).

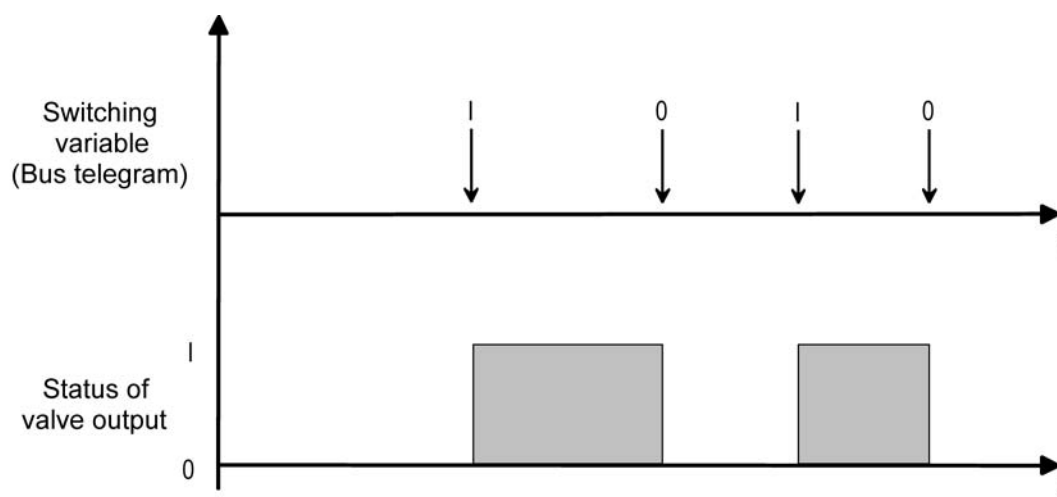

picture 51: Conversion of a switching command value into an output signal with valve drives that are closed when deenergized (example)

For constant command values or constant valve nominal positions (for example for a forced position, manual control or in emergency operation) the valves are either energized or not energized cyclically by means of pulse-width modulation depending on the constant valve position to be approached. In this case the duty cycle of the pulse-width modulation is converted in such a way that the switch-on time corresponds directly to the valve nominal position (see picture 52).

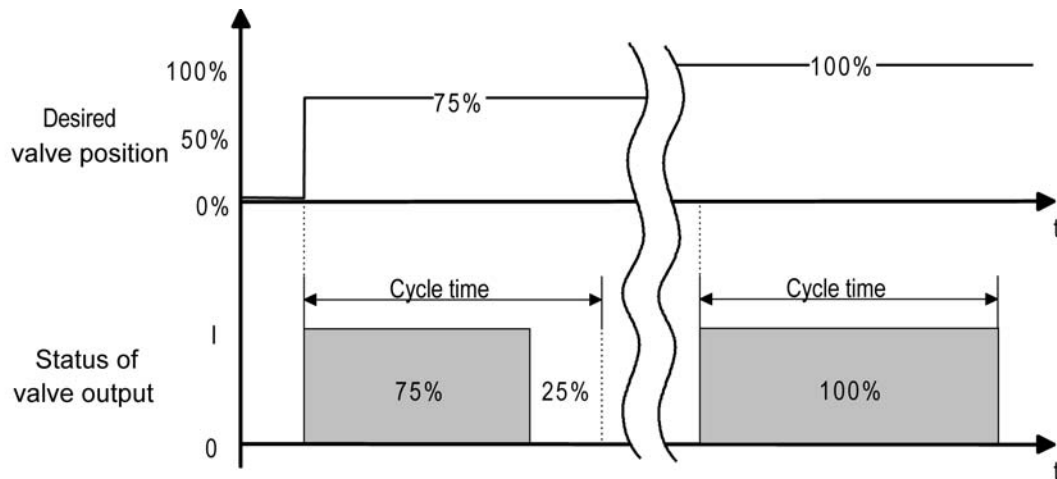

picture 52: Conversion of a constant valve nominal position into an output signal with valve drives that are closed when deenergized (example)

- Set the parameter "Valve direction of action (Valve in deenergized state)" to "open".
 For switching command values the switching telegram received via the "Command value" object is forwarded directly to the corresponding output of the actuator. When an "ON" telegram is received, the output is not energized, thus opening the valve completely. If an "OFF" telegram is received, the valve is closed completely by switching on the output (see picture 53).

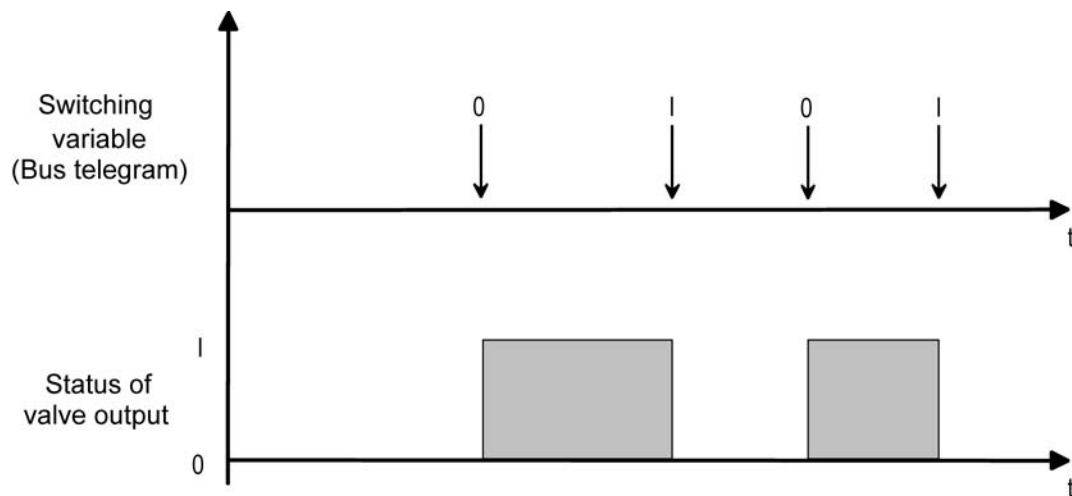

picture 53: Conversion of a switching command value into an output signal with valve drives that are open when deenergized (example)

For constant command values or constant valve nominal positions (for example for a forced position, manual control or in emergency operation) the valves are either energized or not energized cyclically by means of pulse-width modulation depending on the constant valve position to be approached. In this case the duty cycle of the pulse-width modulation is converted in such a way that the switch-off time corresponds directly to the valve nominal position (see picture 54).

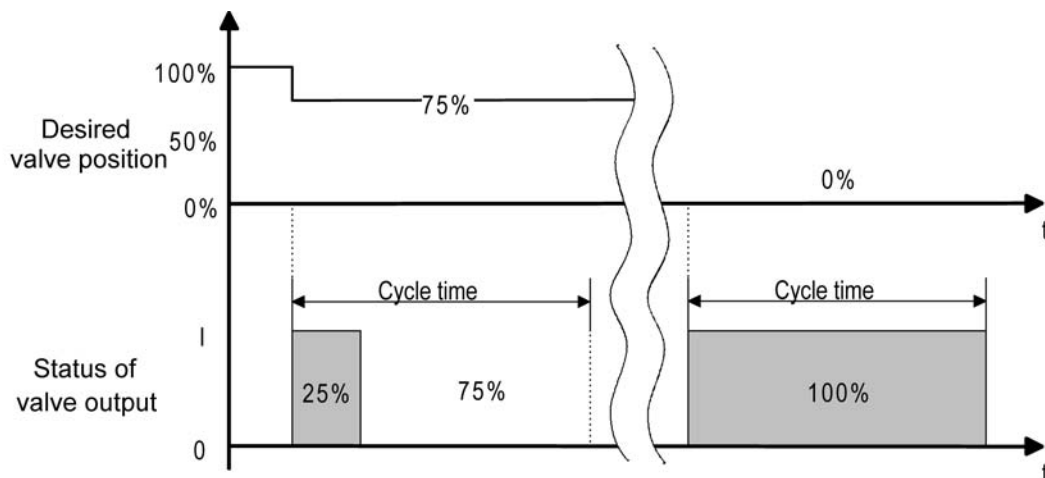

picture 54: Conversion of a constant valve nominal position into an output signal with valve drives that are open when deenergized (example)

- i** Because of the conversion of the PWM switch-on time into the valve nominal position, there is no unwanted mean value displacement for the various valve types.

Example:

Command value: 60 % ->

Duty cycle closed when deenergized: 60 % On, 40 % Off,

Duty cycle open when deenergized: 40 % On, 60 % Off

During pulse-width modulation, the switching edges of both valve outputs at the beginning of a time cycle are only synchronous with each other if both valve outputs receive a new nominal valve position value setting at the same time.

- i** In the event of a failure of the mains voltage on the actuator or a short-circuit on a valve output, the connected valve drives are no longer controlled electrically, so that the drives enter the deenergized state preset by the manufacturer (open or closed in deenergized state).
A valve which is completely open due to a mains voltage failure or short-circuit (valve direction of action open in deenergized state) is evaluated like a closed valve for the actuator status messages ("Command value status", "All valves closed", "Largest command value feedback"), because the valve state was caused by a fault.

Forced position function

Each valve output of the actuator can remain in various operating states, which can be activated via separate communication objects, among other things. One of these object-controlled operating states is the forced position function.

In the forced position function of a valve output, a constant forced valve position (0 % to 100 %) can be saved in the actuator, which is then adopted as the valve nominal position when the forced position function is activated, and executed via a pulse-width modulation. The forced valve position can be set in the ETS differently for summer or winter mode, if mode of operation change-over is enabled.

- i** When a forced position is active, the configured pulse-width modulation is also executed for valve outputs that are parameterized to a switching 1-bit command value.

Enabling the forced position function

The forced position function can be enabled separately for each valve output on the parameter page "Ax - General" (x = number of the valve output).

- Set the parameter "Forced position via object" to "enabled". Configure the parameter " " Value for forced position (0...100%)" to the required forced valve position. The parameter " Value for forced position..." may be visible twice, if mode of operation change-over is enabled. In this case, different forced valve positions can be specified in the ETS for summer and winter mode.

The forced position function is enabled and the 1-bit communication object "Forced position" is visible in the ETS. As soon as an "ON" telegram is received via the object, the actuator activates the forced position for the corresponding valve output and moves the valve drive to the specified forced valve position value. The valve output concerned can then no longer be controlled via command value telegrams from the bus.

If the actuator receives an "OFF" telegram via the forced position object, it deactivates the forced position and re-enables bus control via command values. The last command value received and stored in the actuator before or during the forced position function will be adopted as the new nominal command value after the forced position function is terminated.
- Set the parameter "Forced position via object" to "disabled".

The forced position function is deactivated, and thus the corresponding object is not visible in the ETS.

Nevertheless, the parameter(s) "Value for forced position" or "Value for forced position summer" and "Value for forced position winter" is or are visible and settable in the ETS, because in case of bus voltage failure and after bus/mains voltage return and after ETS programming the forced position value can be adopted as the nominal command value, and must therefore be available in the ETS as a parameterizable value.
- ⓘ The mode of operation (summer/winter) can also be changed via the object while a forced position function is activated. In this case the room actuator adjusts the pulse-width modulation to the valve position value of the valid mode of operation immediately after the change-over.
- ⓘ Updates of the forced-position object from "ON" to "ON" or from "OFF" to "OFF" show no reaction.
- ⓘ Behaviour of the forced position function after bus or mains voltage return: In case of bus or mains voltage failure the state of the "Forced position" object is saved permanently in the actuator.

A forced position function activated via the forced position object before bus or mains voltage failure can then be activated and executed further after bus or mains voltage return, if the "Behaviour after bus or mains voltage return" for the valve output concerned is configured to "State as before bus/mains voltage failure". Otherwise the forced position is always inactive after bus or mains voltage return.

After bus or mains voltage return the mode of operation (summer/winter) is initialised according to the parameter "Mode of operation after device reset".

After ETS programming the forced position function is always inactive.
- ⓘ Forced position and manual control:

Manual control has a higher priority than a forced position. During a forced position manual control can be activated and the forced valve position can be changed. However, at the end of the manual control the forced position is activated again and the forced valve position is set, if the forced position is still activated via the object at that time. If the forced position is no longer active at the end of a manual control, then depending on the parameter setting "Behaviour at the end of permanent manual control during bus operation" the actuator either tracks the last command value received via the bus, or it does not change the last valve position value set via manual control (see chapter 4.2.4.1.1. General channel-independent functions).
- ⓘ The anti-sticking protection has a higher priority than a forced position, which means that forced operation is overridden by the anti-sticking protection. On the other hand, the forced position has a higher priority than emergency operation or operation via command value telegrams.

Behaviour in case of bus voltage failure or after bus or mains voltage return

The state of the valve outputs in case of bus voltage failure, bus or mains voltage return can be preset separately for each output.

Presetting the behaviour in case of bus voltage failure

The parameter "Behaviour in case of bus voltage failure" can be preset separately for each valve output on the parameter page "Ax General" (x = number of the valve output). The parameter defines the behaviour as soon as only the bus voltage fails. The parameterized behaviour will not be executed or tracked if a temporary or permanent manual control mode is active at the time of bus failure.

- Set the parameter to "no reaction".
In the event of bus voltage failure the valve output shows no reaction and remains in the switching state last set, as long as the mains voltage of the actuator is still switched on.
- Set parameter to "Valve closes".
The actuator closes the connected valve drives completely in the event of bus voltage failure, as long as the mains voltage of the actuator and the mains voltage of the valve output are still switched on. In this case, the valve direction of action configured in the ETS for each output is taken into account, with the result that the output is switched off for valves that are closed when deenergized, and energized for valves that are open when deenergized.
- Set parameter to "Valve opens".
The actuator open the connected valve drives completely in the event of bus voltage failure, as long as the mains voltage of the actuator and the mains voltage of the valve output are still switched on. In this case, the valve direction of action configured in the ETS for each output is taken into account, with the result that the output is switched off for valves that are open when deenergized, and energized for valves that are closed when deenergized.
- Set parameter to "valve to value for forced position".
The actuator sets the valve drive to the value for the forced position (0...100 %) configured in the ETS. With the setting 0 % the output concerned is completely closed, with the setting 100 % completely open. The energization of the valve output is always performed taking into account the preset valve direction of action. The forced position value is performed as pulse-width modulation (PWM) even for valve outputs with a switching command value (1 bit)!
With the settings 1...99 % for the forced position value, after bus voltage failure the actuator carries out PWM on the valve output concerned until the bus voltage is switched on again, as a result of which a new valve state may be specified or the valve may be moved via a manual control.
- Set parameter to "valve to value for emergency operation".
The actuator sets the valve drive to the value for the emergency operation (0...100 %) configured in the ETS. With the setting 0 % the output concerned is completely closed, with the setting 100 % completely open. The energization of the valve output is always performed taking into account the preset valve direction of action. The forced position value is performed as pulse-width modulation (PWM) even for valve outputs with a switching command value (1 bit)!
With the settings 1...99 % for the emergency operation value, after bus voltage failure the actuator carries out PWM on the valve output concerned until the bus voltage is switched on again, as a result of which a new valve state may be specified or the valve may be moved via a manual control.

- i** The following must be observed with the settings "Valve to value for forced position" und "Valve to value for emergency operation":
The actuator resorts only to the valve position values (0...100 %) configured in the ETS. The forced position function or emergency operation will not be activated in this case!
The values for forced position and emergency operation are also dependent on the summer/winter mode of the actuator. If mode of operation change-over is enabled for the valve outputs (see page 53), then two separate valve position values for summer and winter mode are configured and distinguished in the ETS.
Thus in the event of a bus voltage failure the mode of operation that was last specified via the communication object "Summer/winter change-over" will be used. If at the time of the bus voltage failure no mode of operation has been specified via the bus, then the room actuator resorts to the "Mode of operation after device reset" configured in the ETS.
- i** In case of a bus or mains voltage failure the states of the last command value/valve nominal position and of the "Forced position" object are saved permanently in the actuator. It is also saved whether a short-circuit or an overload was detected last. The save operation takes place so that the states after bus or mains voltage return will be restored and dependent alarm messages can be transmitted again, if this is parameterized in case of bus/ mains voltage return.
The data are stored before the reaction parameterized for the case of bus voltage failure takes place and only if one part of the supply (mains or bus) is still present, or if the supply fails completely after the mains voltage has been available before without interruption for at least 20 seconds after the last reset (storage capacitors sufficiently charged for storage purposes). In all other cases nothing is stored.
The saving process is performed only once after the failure of one part of the supply voltage...
Example 1:
Bus voltage failure -> saving process -> then mains voltage failure -> no additional saving process,
Example 2:
Mains voltage failure -> saving process -> then bus voltage failure -> no additional saving process,
- i** In the event of a failure of the mains voltage, the valve drives are no longer controlled electrically, so that irrespective of the state of the bus voltage the drives enter the deenergized state preset by the manufacturer (see chapter 4.2.4.1.1. General channel-independent functions).
- i** The manual mode, if active, will not be terminated by a bus voltage failure.

Presetting the behaviour in case of bus or mains voltage return

The parameter "Behaviour after bus or mains voltage return" can be preset separately for each valve output on the parameter page "Ax General" (x = number of the valve output). The parameter defines the behaviour as soon as either the bus or mains voltage is switched on.

- Set parameter to "no reaction".
After bus or mains voltage return the valve output shows no reaction and remains in the switching state last set before or during bus/mains failure.
- Set parameter to "Valve closes".
The actuator closes the connected valve drives completely after bus or mains voltage return. In this case, the valve direction of action configured in the ETS for each output is taken into account, with the result that the output is switched off for valves that are closed when deenergized, and energized for valves that are open when deenergized.
- Set parameter to "Valve opens".
The actuator opens the connected valve drives completely after bus or mains voltage return. In this case, the valve direction of action configured in the ETS for each output is taken into account, with the result that the output is switched off for valves that are open when deenergized, and energized for valves that are closed when deenergized.
- Set parameter to "valve to value for forced position".

The actuator sets the valve drive to the value for the forced position (0...100 %) configured in the ETS. With the setting 0 % the output concerned is completely closed, with the setting 100 % completely open. The energization of the valve output is always performed taking into account the preset valve direction of action. The forced position value is performed as pulse-width modulation (PWM) even for valve outputs with a switching command value (1 bit)!

With the settings 1...99 % for the forced position value, after bus or mains voltage return the actuator carries out PWM on the valve output concerned until a new valve state is specified.

- Set parameter to "valve to value for emergency operation".

The actuator sets the valve drive to the value for the emergency operation (0...100 %) configured in the ETS. With the setting 0 % the output concerned is completely closed, with the setting 100 % completely open. The energization of the valve output is always performed taking into account the preset valve direction of action. The forced position value is performed as pulse-width modulation (PWM) even for valve outputs with a switching command value (1 bit)!

With the settings 1...99 % for the emergency operation value, after bus or mains voltage return the actuator carries out PWM on the valve output concerned until a new valve state is specified.

- Set parameter to "state as before bus / mains failure".

After bus or mains voltage return, the state last existing and internally stored before bus or mains voltage failure (last command value/valve nominal position and state of the "Forced position" object) will be tracked.

- i** The device executes the parameterized "Behaviour after bus or mains voltage return" only if more than approx. 20 s have elapsed between the last ETS programming of the application or of the parameters and the time when the bus or mains voltage is restored. Otherwise ($T_{ETS} < 20$ s) the "Behaviour after ETS programming" will be executed also in case of a bus/mains voltage return.
- i** The following must be observed with the settings "Valve to value for forced position" and "Valve to value for emergency operation":
 The actuator resorts only to the valve position values (0...100 %) configured in the ETS. The forced position function or emergency operation will not be activated in this case!
 The values for forced position and emergency operation are also dependent on the summer/winter mode of the actuator. If mode of operation change-over for the valve outputs is enabled (see page 53), then two separate valve position values for summer and winter mode are configured and distinguished in the ETS.
 After bus or mains voltage return the room actuator re-initialises itself and uses the mode of operation configured in the ETS in the parameter "Mode of operation after device reset".
- i** For setting "state as before bus/mains voltage failure": ETS programming of the application or of the parameters deletes the internally stored states.
- i** A valve state set after bus or mains voltage return will be tracked in the status object.
- i** The cycle time of the anti-sticking protection is only restarted after the supply voltage of the actuator is switched on again completely (bus and mains voltage return. The cycle time of the cyclical command value monitoring will be restarted both after return of bus voltage only and after return of mains voltage only.
- i** An active manual control is always terminated on return of bus voltage. In case of mains failure, no manual control is possible.
- i** The valve state configured in the ETS is set after bus or mains voltage return. In this case the status messages "All valves closed" and "Largest command value feedback" are updated by the room actuator in accordance with the current state, and a telegram is sent to the bus, if the status messaging function is enabled. In addition, the current mains voltage status (mains voltage present / not present) is transmitted actively to the bus, if so enabled. The transmission of the status telegrams and messages only takes place, however, after the end of the "Delay after bus voltage return" configured in the ETS.

- i** A short-circuit message that was transmitted to the bus after detection of the fault and has not yet been reset is saved in the actuator in the event of a bus voltage failure. After bus voltage return a previously saved message is transmitted to the bus again, if the short-circuit was not reset during the bus voltage failure, and is thus still present. The actuator cancels the short-circuit message after bus voltage return by transmitting an alarm telegram in accordance with the polarity set in the ETS, if during the bus voltage failure a previously reported short-circuit was eliminated and reset.

Short-circuit and overload protection

The room actuator monitors the two valve outputs independently of each other for short-circuits and overload, as soon as the outputs are switched on and energized.

The actuator detects short-circuits of the valve outputs against neutral conductor potential or a 'current-related' overload on the connected electrothermal valve drives (see picture 55).

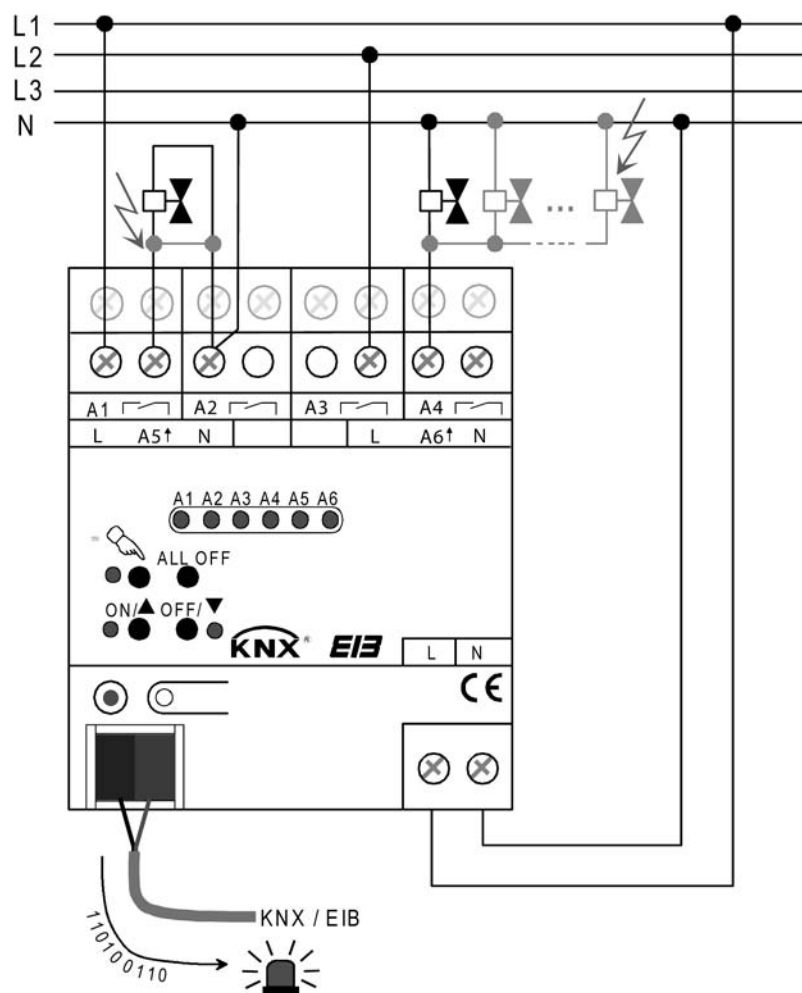

picture 55: Short-circuit and overload detection in the event of a fault in a valve output or valve drive

Short-circuit and overload detection with switch-off and test procedure:

As soon as the room actuator detects a short-circuit or overload fault, it immediately deenergizes the valve output concerned and enters the fault state. In the fault state it is no longer possible to control the valve output via the bus. The room actuator continues to receive and store command value and forced position telegrams, but does not execute these telegrams and also no longer sends any status feedback messages to the bus.

Only if the fault has still not been eliminated 6 minutes after it is first detected and is still present will the actuator remain in the fault state and transmit an alarm telegram to the bus. This alarm

message can be enabled and evaluated separately for each valve output. Independently of the alarm message, after the 6-minute detection time if the fault is still present the actuator transmits a command value status telegram "0 %" or "OFF" to the bus, thus indicating a deactivated valve output.

- i** A valve which is completely open due to a short-circuit (valve direction of action open in deenergized state) is evaluated like a closed valve for the status feedback messages, because the valve state was caused by a fault.

If the fault is no longer present 6 minutes after it is first detected (e.g. a short switch-on overload, the room actuator switches the valve output concerned on independently of the command value for an additional uninterrupted period of 4 minutes. Only if no new short-circuit and no new overload is detected during this additional switch-on phase of the test procedure will the room actuator terminate the fault state after the 4 minutes elapse, without transmitting an alarm message.

The actuator then reactivates the tracked nominal valve position that was last active before the short-circuit or overload fault or which was last received by the bus during the fault state. The actuator therefore if necessary switches on the valve output previously switched off and also updates its status feedback messages. In this case any forced position is also tracked, if one was activated before the fault or during the fault.

- i** The cyclical command value monitoring is not active during the fault state. Only when the fault state is reset will the cycle time of the cyclical monitoring be restarted.

Resetting a short-circuit/overload fault:

The following procedures can be used to put back into operation a valve output that has become faulty due to a short-circuit or overload...

- switching the mains voltage of the room actuator off and on again,
- switching the valve output on again via permanent manual control locally on the room actuator,
- ETS programming.

In case of a reset the alarm message is cancelled directly by transmission of an alarm telegram in accordance with the polarity set in the ETS (no alarm).

If after the reset outputs are still overloaded or short-circuited, the actuator (if switched on) detects the fault and starts the test cycle again as described above.

When a fault is reset by switching off the mains voltage, immediately after the mains failure an alarm telegram is also transmitted to the bus as part of mains voltage monitoring, if this function is enabled in the ETS (see chapter 4.2.4.1.1. General channel-independent functions).

- i** In the event of a short-circuit on a valve output, the connected valve drives are no longer controlled electrically, so that the drives enter the deenergized state preset by the manufacturer (open or closed in deenergized state).
A valve which is completely open due to a short-circuit (valve direction of action open in deenergized state) is evaluated like a closed valve for the status feedback messages ("Command value status", "Largest command value feedback", "All valves closed"), because the valve state was caused by a fault.

Enabling an alarm object for short-circuit/overload detection

The short-circuit and overload detection is generally active for the valve outputs. Optionally, a 1-bit alarm object can be enabled separately for each valve output on the parameter page "Ax

General (x = number of the valve output), which makes it possible to signal a fault mode caused by a short-circuit or overload in the bus.

- Set the parameter "Alarm object for overload / short-circuit" to "enabled".
The short-circuit and overload signalling via the "Short-circuit / overload alarm" is enabled. If the actuator has detected a fault on the valve output concerned, after the 6-minute detection time elapses it transmits an alarm telegram to the bus, if the fault is still present. The alarm message is only cancelled if the fault has been reset.
- Set the parameter "Alarm object for overload / short-circuit" to "disabled".
The short-circuit and overload signalling via the "Short-circuit / overload alarm" is deactivated. If the actuator detects a fault on the valve output concerned, it switches the output off and enters the fault mode without transmitting an alarm telegram.
- i** An alarm message that was transmitted to the bus after detection of the fault and has not yet been reset is saved in the actuator in the event of a bus voltage failure. After bus voltage return a previously saved message is transmitted to the bus again, if the fault was not reset during the bus voltage failure, and is thus still present.
The actuator cancels the alarm message after bus voltage return by transmitting an alarm telegram in accordance with the polarity set in the ETS (no alarm), if during the bus voltage failure a previously reported fault was eliminated and reset.
- i** After ETS programming the alarm message is initially not active. The room actuator transmits to the bus an alarm telegram for initialisation in accordance with the polarity set in the ETS (no alarm). Only when a valve output has been switched on and a fault has been detected after the ETS programming will the actuator enter the fault mode for the valve output concerned and start the test procedure described above.

Setting the telegram polarity for the alarm object for short-circuit / overload

The telegram polarity of the 1-bit object "Short-circuit / overload alarm" can be set separately for each valve output. The polarity can be configured on the parameter page "Ax General" (x = number of the valve output).

The alarm object must have been enabled previously.

- Set the parameter "Polarity of 'Overload / short-circuit' object" to "obj. val. in case of overload / short-circuit = 0".
A short-circuit or overload fault is signalled via an "OFF" telegram (alarm). When the fault is reset an "ON" telegram is transmitted to the bus (no alarm).
- Set the parameter "Polarity of 'Overload / short-circuit' object" to "obj. val. in case of overload / short-circuit = 1".
A short-circuit or overload fault is signalled via an "ON" telegram (alarm). When the fault is reset an "OFF" telegram is transmitted to the bus (no alarm).

Setting time delay for alarm message for short-circuit / overload after bus voltage return

An alarm message that was transmitted to the bus after detection of the fault and has not yet been reset is saved in the actuator in the event of a bus voltage failure. After bus voltage return a previously saved message (alarm) is transmitted to the bus again, if the fault was not reset during the bus voltage failure, and is thus still present. Even if no alarm message is active, a message telegram (no alarm) is transmitted to the bus after bus voltage return and after ETS programming.

In these cases, transmission of the alarm telegram can be delayed. The time delay can be configured on the parameter page "Ax General" (x = number of the valve output).

The alarm object must have been enabled previously.

- Set the parameter "Time delay for message after bus voltage return ?" to "Yes".
The time delay for the alarm message after bus voltage return or ETS programming is activated. The time delay is defined independent of the channel for all status messages and feedback messages of the actor on parameter page "General" in the parameter "Delay after bus voltage return (0...59 s)".

- Set the parameter "Time delay for message after bus voltage return ?" to "Yes".
The time delay for the alarm message after bus voltage return or ETS programming is inactive. The alarm message is transmitted immediately after the device initialisation.

Command value evaluation

The valve outputs of the room actuator can be controlled via switching with a 1-bit command value telegram or alternatively constantly with a 1-byte command value telegram. Constant command values are converted via pulse-width modulation at the output. The cycle time of the output signals is generally parameterizable in this case.

Command value telegrams are generally transmitted to the room actuator by a KNX/EIB room thermostat via the bus. The room thermostat generates the command value telegrams based on a control algorithm. It should be noted that the room actuator itself does not function as a thermostat!

Configuring the type of command value (1 bit / 1 byte)

The type of command value can be set separately for each valve output. This can be configured on the parameter page "Ax Command value" (x = number of the valve output).

- Set the parameter "Type of command value" to "switching (1 bit)".
In normal operation, the switching telegram received via the 1-bit object "Command value" is forwarded directly to the corresponding valve output of the actuator, taking into account the valve direction of action (open in deenergized state / closed in deenergized state (see picture 56). Thus when an "ON" telegram is received, the valve is opened completely (output energized for valve direction of action = closed / output not energized for valve direction of action = open).

The valve is closed completely when an "OFF" telegram is received (output not energized for valve direction of action = closed / output energized for valve direction of action = open).

In case of a forced position, in emergency operation, after ETS programming, in case of bus voltage failure, in case of bus and mains voltage return, and in case of manual control, a constant nominal valve position value (0...100 %) can be parameterized and activated in the ETS also for a command value of 1-bit size. In this case the nominal value is set on the valve output concerned via a pulse-width modulation, taking into account the parameter "Cycle time (PWM of the outputs)" (see "Pulse-width modulation with constant command values and constant nominal valve positions").

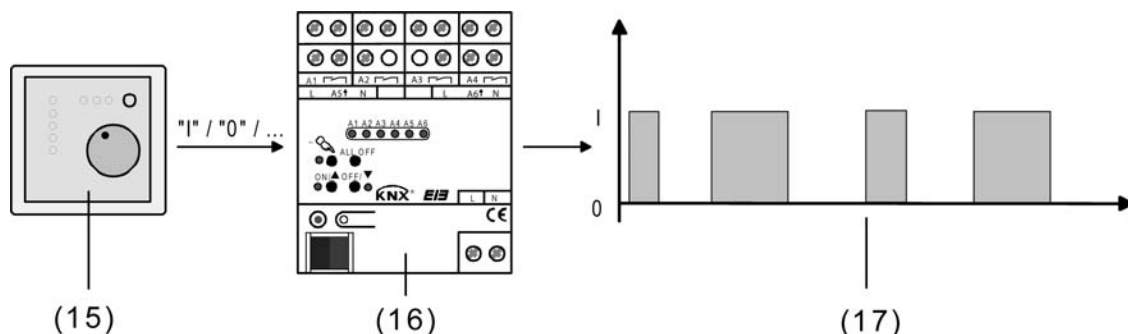

picture 56: Command value principle with switching command value

(15) Room thermostat (command value "1 bit")

(16) Room actuator

(17) Switching output signal for valve drives

- Set the parameter "Type of command value" to "constant (1 byte)".

In normal operation, the value telegram received via the 1-byte object "Command value" is converted by the actuator into an equivalent pulse-width modulated switching signal on the valve outputs (see picture 57). The mean value of the output signal resulting from this modulation is a measure for the averaged valve position of the control valve, taking into account the cycle time (T) which can be set in the actuator, and thus a reference for the set room temperature (see "Pulse-width modulation with constant command values and constant nominal valve positions").

The average value can be shifted, thus changing heating or cooling output, by changing the duty cycle of the switch-on and switch-off pulses of the output signal. The duty cycle is adapted by the actuator depending on the command value received (normal operation) or the valve nominal position (forced position, emergency operation, after ETS programming, in case of bus voltage failure, in case of bus and mains voltage return, manual control).

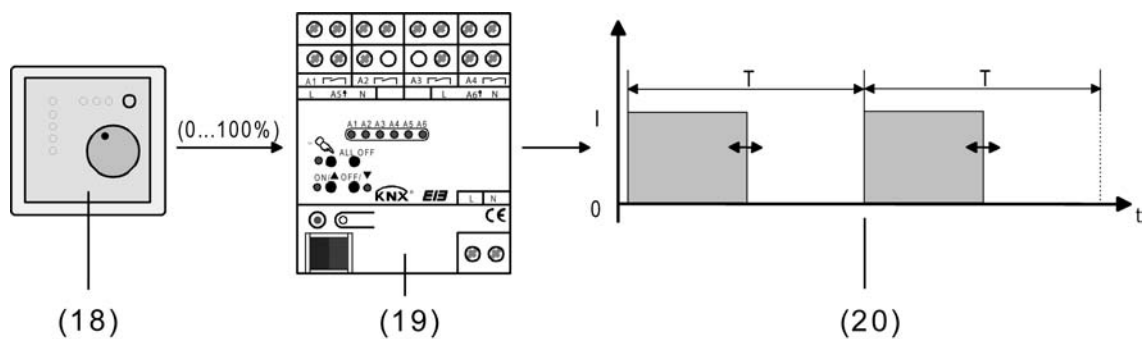

picture 57: Command value principle with constant command value

(18) Room thermostat (command value "1 byte")

(19) Room actuator

(20) Pulse-width modulated output signal for valve drives

Pulse-width modulation with constant command values and constant nominal valve positions

Functional principle of a pulse-width modulation:

When the room actuator is to set a constant command value or a constant nominal valve position value configured in the ETS for a valve output, it modulates the output signal using the switch-on pulse width. The mean value (M) of the output signal resulting from this modulation is a measure for the averaged valve position of the control valve, taking into account the cycle time (T) which can be set in the actuator, and thus a reference for the set room temperature (see picture 58).

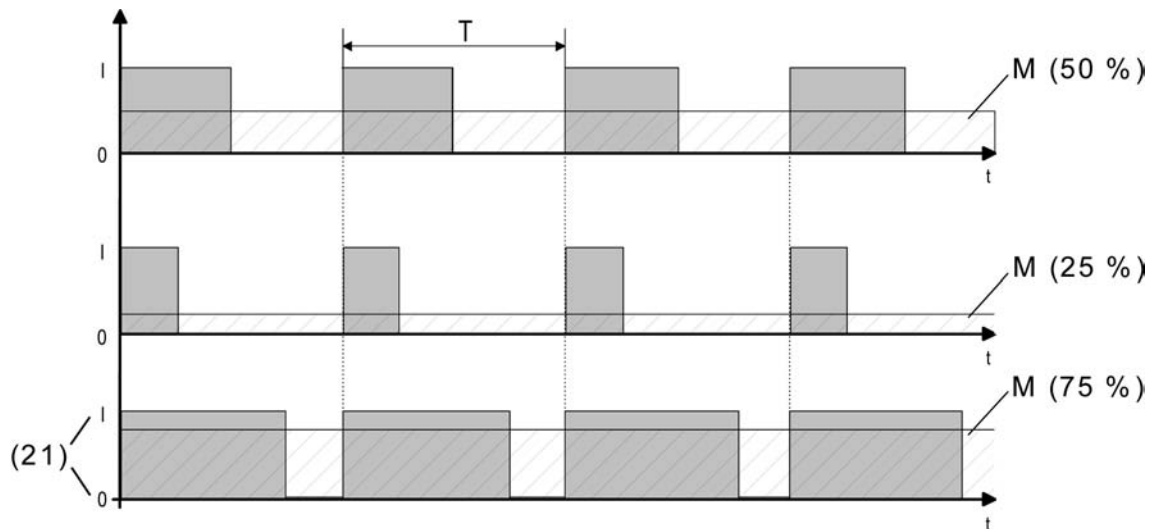

picture 58: Pulse-width modulation of a valve output signal

(21) Valve state (0 = Valve closed / 1 = Valve open)

The average value can be shifted, thus changing heating or cooling output, by changing the duty cycle of the switch-on and switch-off pulses of the output signal. The duty cycle is adapted by the actuator depending on the command value received (normal operation) or the valve nominal position (forced position, emergency operation, after ETS programming, in case of bus voltage failure, in case of bus and mains voltage return, manual control).

Adaptation of the pulse-width modulation:

Control circuits are often subject to changes in the nominal value specification (e.g. frost protection, night mode, etc.) or disturbances with short-term effects (e.g. fluctuations in measured values due to brief opening of windows or doors in the vicinity of the sensor).

So that in these cases the setting of the duty cycle of the desired command value can be obtained as quickly and accurately as possible, even with longer cycle times (typically 10...20 minutes), without having a negative effect on the response time of the controlled system, the actuator makes use of a special, very effective procedure for continuous command value adaptation.

The following cases can be distinguished...

Case 1:

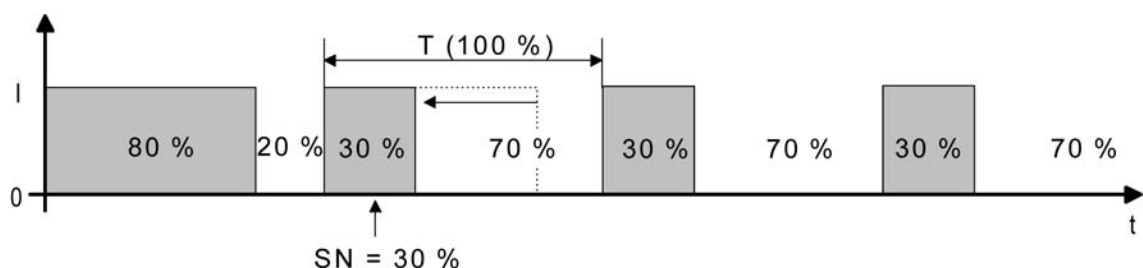

picture 59: Command value change e.g. from 80 % to 30 % during the opening phase of the valve

Before a new nominal valve position value (SN = 30 %) is specified, the old nominal value (80 %) was active. Then the new nominal value is specified during the opening phase of the valve. At that time the actuator detects that it is still possible to shorten the opening phase so that it corresponds to the new valve position (30 %). The cycle time (T) is not affected by this procedure.

The new duty cycle is set immediately after receipt of the new nominal valve position value.

Case 2:

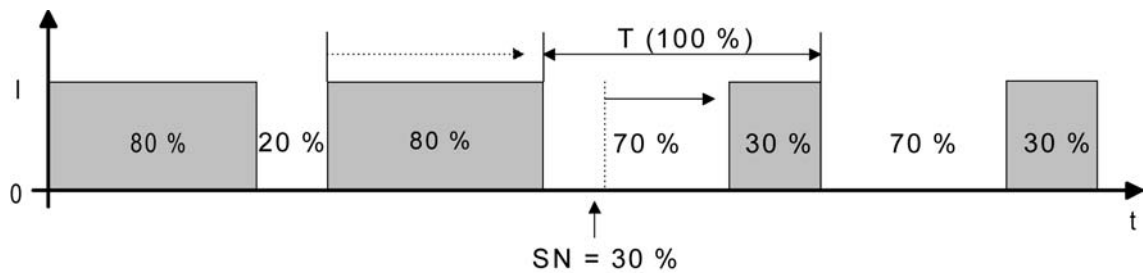

picture 60: Command value change e.g. from 80 % to 30 % during the closing phase of the valve

Before a new nominal valve position value (SN = 30 %) is specified, the old nominal value (80 %) was active. Then the new nominal value is specified during the closing phase of the valve. At that time the actuator detects that it is still possible to extend the closing phase so that it corresponds to the new valve position (30 %). The cycle time (T) is not changed, but the start time of the period is shifted automatically.

The new duty cycle is set immediately after receipt of the new nominal valve position value.

Case 3:

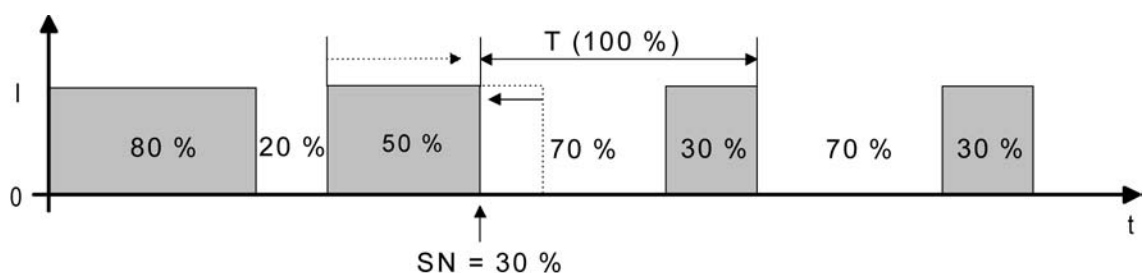

picture 61: Command value change e.g. from 80 % to 30 % during the opening phase of the valve (opening phase too long)

Before a new nominal valve position value (SN = 30 %) is specified, the old nominal value (80 %) was active. Then the new nominal value is specified during the opening phase of the valve. At that time the actuator detects that it is necessary to abort the opening phase and close the valve, so that the duty cycle corresponds to the new valve position (30 %). The cycle time (T) is not changed, but the start time of the period is shifted automatically.

The new duty cycle is set immediately after receipt of the new nominal valve position value.

Case 4:

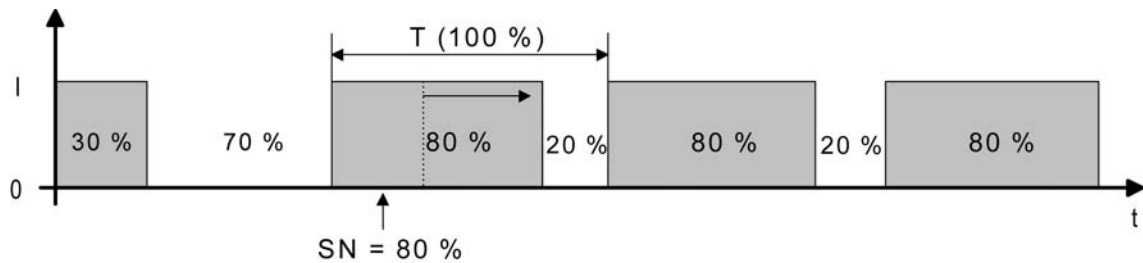

picture 62: Command value change e.g. from 30 % to 80 % during the opening phase of the valve

Before a new nominal valve position value (SN = 80 %) is specified, the old nominal value (30 %) was active. Then the new nominal value is specified during the opening phase of the valve. At that time the actuator detects that it is still possible to extend the opening phase so that it corresponds to the new valve position (80 %). The cycle time (T) is not affected by this procedure.

The new duty cycle is set immediately after receipt of the new nominal valve position value.

Case 5:

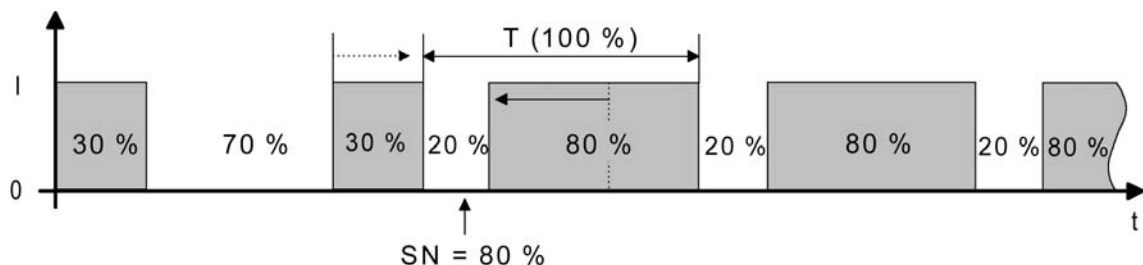

picture 63: Command value change e.g. from 30 % to 80 % during the closing phase of the valve

Before a new nominal valve position value (SN = 80 %) is specified, the old nominal value (30 %) was active. Then the new nominal value is specified during the closing phase of the valve. At that time the actuator detects that it is still possible to shorten the closing phase so that it corresponds to the new valve position (80 %). The cycle time (T) is not changed, but the start time of the period is shifted automatically.

The new duty cycle is set immediately after receipt of the new nominal valve position value.

Case 6:

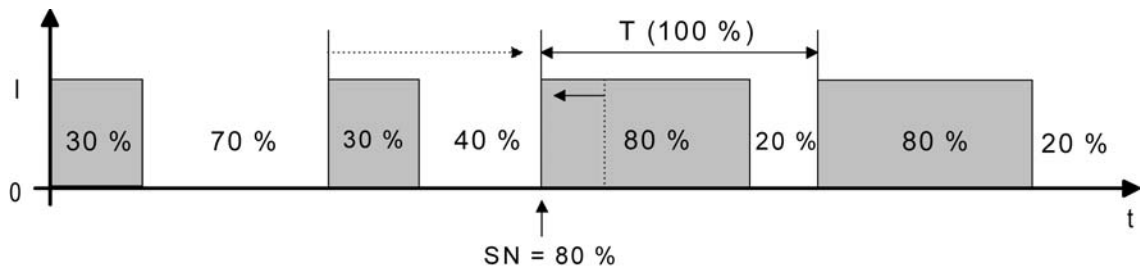

picture 64: Command value change e.g. from 30 % to 80 % during the closing phase of the valve (closing phase too long)

Before a new nominal valve position value (SN = 80 %) is specified, the old nominal value (30 %) was active. Then the new nominal value is specified during the closing phase of the valve. At that time the actuator detects that it is necessary to abort the closing phase and open the valve, so that the duty cycle corresponds to the new valve position (80 %). The cycle time (T) is not changed, but the start time of the period is shifted automatically.

The new duty cycle is set immediately after receipt of the new nominal valve position value.

Cycle time of the pulse-width modulation:

The cycle time defines the switching frequency of a pulse-width modulated output signal. The variable adjustment capability of the cycle time in the ETS makes it possible to adapt it to the adjustment cycle times of the valve drives being used (time needed by the drive to move the valve from the completely closed position to the completely open position). The reaction times of the valve drives (time during which the valve drives do not show any reaction when they are switched on or off) must be taken into account. If various drives with different adjustment cycle times are used, then the largest of these times should be taken into account.

The cycle time is defined in common for both valve outputs on the parameter page "Valve output times".

- i Depending on the drives being used, it may be necessary to energize them for a longer period in order to make the valves ready for operation (note the drive manufacturer's instructions)!

Basically two cases can be distinguished for configuration of the cycle time...

Case 1: cycle time > 2 x adjustment cycle time of the electrothermal drives being used

In this case the switch-on or switch-off times of the actuator are long enough so that the drives still have enough time to open or close completely during a period.

Advantages:

The desired mean value for the command value and thus the required room temperature are set relatively precisely, even if multiple drives are controlled at the same time.

Disadvantages:

It should be noted that because of the full valve stroke that has to be 'moved through' constantly, the life expectancy of the drives may decrease. In some circumstances, with very long cycle times (> 15 minutes) and systems with low inertia the heat output to the room in the vicinity of the radiators may be uneven and feel uncomfortable.

- i** This setting for the cycle time is recommended for high-inertia heating systems (e.g. under-floor heating).
- i** This setting is also recommended when there is a large number of (possibly different) drives to be controlled, so that the travel paths of the valves can be averaged better.

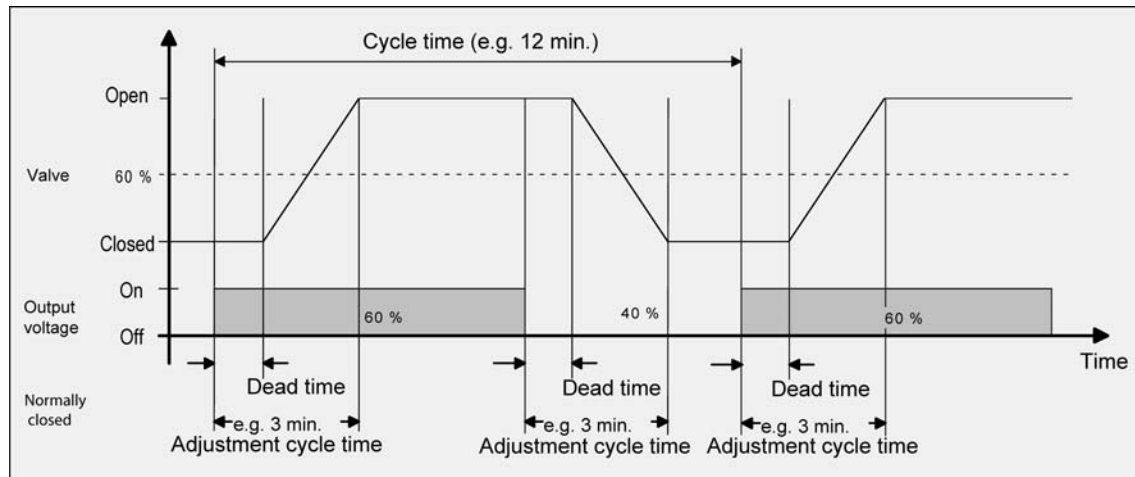

picture 65: Idealised curve of the valve stroke: example for a command value of approx. 60 % for a valve closed when deenergized

Case 2: cycle time < adjustment cycle time of the electrothermal drives being used

In this case the switch-on or switch-off times of the actuator are so short that the drives do not have enough time to open or close completely during a period.

Advantages:

This setting ensures that there is a continuous flow of water through the radiators, and thus an even heat output to the room.

If only one valve drive is controlled, it is possible for the thermostat to use continuous adjustment of the command value to compensate for the mean value displacement caused by the short cycle time, thus setting the desired room temperature.

Disadvantages:

If more than one drive is controlled at the same time, the desired mean value for the command value and thus the required room temperature can only be set very poorly and/or with large deviations.

- i** This setting for the cycle time is recommended for 'faster' heating systems (e.g. flat-panel radiators).

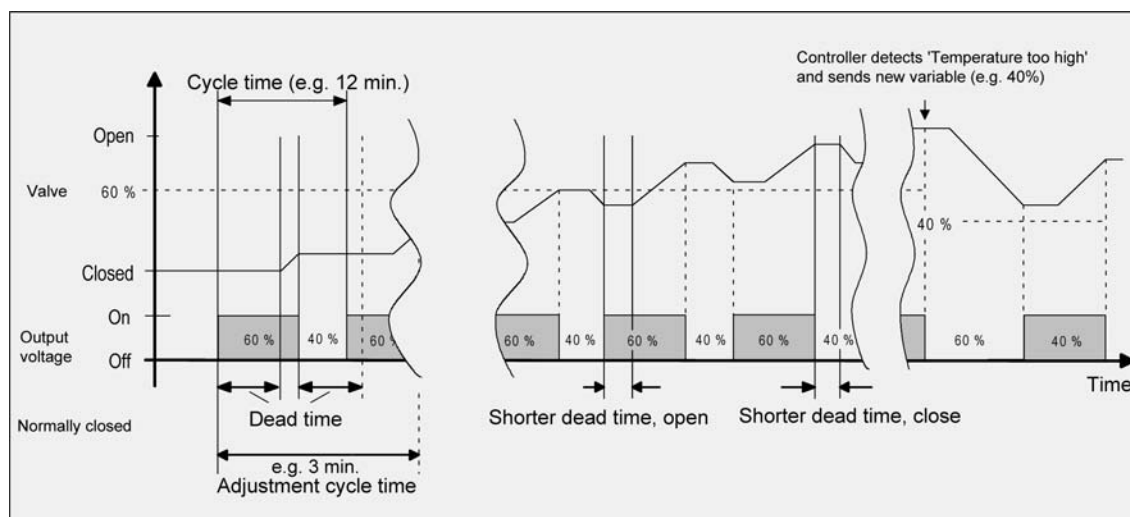

picture 66: Idealised curve of the valve stroke: example for an initial command value of approx. 60 % for a valve closed when deenergized

The continual flow of water through the valve and the resulting constant heating of the drive change the reaction times of the valves in the opening and closing phases. Because of the short cycle time, and taking into account the reaction times, in some circumstances the required command value (mean value) can only be set with a large deviation. In order to adjust the room temperature to a constant temperature after a certain time, the thermostat has to use continuous adjustment of the command value to compensate for the mean value displacement caused by the short cycle time. Usually the control algorithm (PI control) serves to compensate for control deviations.

Status message for valve position

The room actuator makes available a command value status message independently for each valve output. The communication object "Command value status" can be used to transmit to the bus the current valve nominal position depending on the configured command value data format (1 bit or 1 byte). In this manner the state of a valve can be transmitted to the bus at any time and displayed in a visualisation or evaluated further in other bus devices.

The status objects are updated after the following events...

- a change in the command value received from the bus,
- a change in the specified valve nominal position via forced position, emergency operation, manual control or in case of mains voltage failure,
- always after ETS programming or bus or mains voltage return,
- always, if a short-circuit or an overload contributed to switching-off of a valve output.

The status object always specified the value of the valve nominal position. In the case of constant 1-byte command values, in accordance with KNX datapoint type 5.001 the absolute value of the valve nominal position is tracked directly in the status object ("0" = 0% ... "255" = 100 %). In the case of switching 1-bit command values, the state "closed" ("0") or "open" ("1") is tracked according to KNX datapoint type 1.001.

The valve direction of action configured in the ETS is not included in the determination of the status message. The direction of action merely defines the energization state of a valve output in the open or closed valve position.

In the forced position of a valve output, in emergency operation, in case of manual control or after ETS programming, in case of bus voltage failure, or after bus and mains voltage return, it is possible to activate a constant valve position (0 % to 100 %). In these cases the configured

valve nominal position is also executed as pulse-width modulation (PWM) for valve outputs that are parameterized to a switching 1-bit command value. In this case a PWM for valve outputs with a 1-bit command value format is reported back in the status object as "Valve open" ("1").

- i** In the event of a failure of the mains voltage on the actuator or a short-circuit on a valve output, the connected valve drives are no longer controlled electrically, so that the drives enter the deenergized state preset by the manufacturer (open or closed in deenergized state).
A valve which is completely open due to a mains voltage failure or short-circuit (valve direction of action open in deenergized state) is evaluated like a closed valve for the actuator status messages ("Command value status", "All valves closed", "Largest command value feedback"), because the valve state was caused by a fault.
- i** The anti-sticking protection is always carried out 'in the background', and is not reported to the bus via the status objects.

Enabling and configuring a status message for valve position

Status messages are configured separately for the valve outputs on the parameter page "Ax - Command value" (x = number of the valve output).

Independent of the data format of the command value, a distinction is made as to whether the status object of a valve output acts as an actively transmitting signalling object, or as a passive status object.

The configuration as a signalling or status object is performed in the ETS, which then automatically sets the necessary communication flags of the status object.

- Set the parameter "Transmit status of the valve position ?" to "status object is actively transmitting".

The status message is enabled. As soon as the actuator updates the status message, a telegram is also transmitted to the bus. The "Transmit" flag is automatically set in the bus under the status object.

- i** It is entirely possible, even when a signalling object is active, to set the "Read" flag in the ETS subsequently, in order to keep the read-out functionality of the object.

- Set the parameter "Transmit status of the valve position ?" to "status object is passively readable".

The status message is enabled. The actuator updates only the status object internally, and does not transmit any telegram. The object value can be read out via the bus at any time (ValueRead), as a result of which the actuator then transmits a response telegram (ValueResponse). The "Read" flag is automatically set in the bus under the status object.

- Set the parameter "Transmit status of the valve position ?" to "no status".

The communication object is blanked out in the ETS, which means that the status messaging function is completely inactive.

Setting time delay for status messaging after bus voltage return

It is possible to set a time delay for the actively transmitting status messages after bus voltage return (switching on of the bus voltage), and also after ETS programming. This can be useful, for example, in order to reduce the bus load if after a bus reset several devices are carrying out initialisation of their status or feedback objects at the same time. Here it is advisable to define different time delays in the devices, so that the transmission of the message telegrams is staggered in time.

For this purpose a channel-independent delay time can be defined in the actuator. Only after the parameterized time elapses are status telegrams for initialisation transmitted to the bus.

Whether the status message is transmitted with a time delay after initialisation can be con-

figured on the parameter page "Ax - Command value" (x = number of the valve output). This setting is performed independently for each valve output.

The delay time itself is configured independent of the channel on the parameter page "General".

The status message for the valve positions must have been enabled as 'actively transmitting'.

- Set the parameter "Time delay for status after bus voltage return" to "Yes".
After the bus voltage supply is switched on or after ETS programming the status message is transmitted with a time delay.
- Set the parameter "Time delay for status after bus voltage return" to "No".
After the bus voltage supply is switched on or after ETS programming the status message is transmitted to the bus immediately after initialisation of the actuator.

Cyclical command value monitoring

The room actuator makes it possible to monitor the command value for each valve output. This monitoring checks whether command value telegrams have been received by the room actuator within a time interval that can be defined in the ETS. If no telegrams are received during the monitoring time, the actuator activates the emergency operation and set the connected valve drives to an emergency operation valve position parameterized in the ETS. As a rule, a room thermostat transmits its command values cyclically to the bus if cyclical monitoring has been activated in the room actuator (see picture 67).

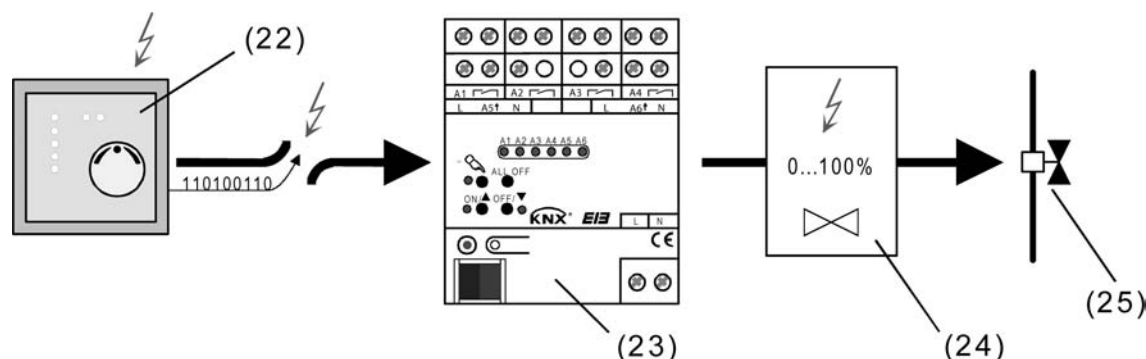

picture 67: Principle of cyclical command value monitoring in the event of a fault (e.g. open circuit)

- (22) Faulty room thermostat with cyclical telegram transmission of the command values
- (23) Room actuator in emergency operation
- (24) Nominal valve position value for emergency operation
- (25) Valve drive

The monitoring time can be configured in the room actuator in common for all valve outputs from 1 minute to 59 minutes, in which case the room actuator automatically adds an additional safety time window of 30 seconds on top of the parameterized time. Each valve output has its own timer, which is initialised with the defined monitoring time.

During the monitoring time the room actuator expects at least one command value telegram per valve output. If a telegram is received, then the actuator resets the monitoring time for the valve output concerned and restarts the time interval.

The cyclical monitoring begins immediately after commissioning via the ETS, or after the bus or mains voltage is switched on. Consequently, if only the mains voltage is switched on, after the monitoring time elapses the room actuator would switch to emergency operation, if the bus voltage has still not been switched on.

If when bus voltage is switched on no telegram is received before the end of the monitoring

time, the valve output immediately assumes the valve state for emergency operation configured in the ETS. In this case the actuator can also transmit a 1-bit alarm message to the bus via the object "Command value monitoring alarm", if the alarm object is linked in the ETS with a group address. The telegram polarity of this alarm message can be configured in the ETS.

The valve state for emergency operation is saved in the ETS as a constant emergency valve position (0 %... 100 %), which is adopted as the valve nominal position when emergency operation is active, and is executed via a pulse-width modulation. The emergency valve position can be set in the ETS differently for summer or winter mode, if mode of operation change-over is enabled.

- i** When emergency operation is active, the configured pulse-width modulation is also executed for valve outputs that are parameterized to a switching 1-bit command value.

Only when a new command value telegram is received does the actuator reset the monitoring time, reset it, and reset the valve output in accordance with the command value specification. The emergency operation will then be terminated automatically. The alarm message is also retracted here by having the actuator transmit an inverted alarm message telegram to the bus.

Enabling cyclical command value monitoring

The cyclical monitoring of the command value can be enabled separately for each valve output on the parameter page "Ax - Command value" (x = number of the valve output).

- Set the parameter "Cyclical monitoring of the command value" to "enabled". Configure the "Time for cyclical monitoring command values" on the parameter page "Valve output times" to the required monitoring time. The time set there should correspond to the time for the cyclical transmission of the command value of the room thermostat. Configure the parameter "Value for emergency operation (0...100%)" on the parameter page "Ax - General" to the required emergency valve position. The parameter "Value for emergency operation..." may be visible twice, if mode of operation change-over is enabled. In this case, different emergency valve positions can be specified in the ETS for summer and winter mode.

The cyclical command value monitoring is enabled and the communication object "Command value monitoring alarm" becomes visible in the ETS.

In fault-free operation the command value object of the corresponding valve output must have telegrams transmitted to it cyclically within the monitoring time.

- Set the parameter "Cyclical monitoring of the command value" to "disabled". The cyclical monitoring is completely disabled. No telegram monitoring of the command value object is performed.
- i** During temporary or permanent manual control, when a forced position is activated or during a short-circuit or overload fault the command value is not monitored; the cyclical command value monitoring is then generally inactive for priority reasons. At the end of a manual control or forced position, in case of bus or mains voltage return or in case of resetting of a short-circuit/overload fault, the monitoring time of the command value monitoring is restarted.
- i** After bus or mains voltage return and after ETS programming the object "Command value monitoring alarm" is initialised, so that the room actuator also transmits a telegram to the bus. After bus voltage return and after ETS programming the automatic transmitting of the alarm telegram only takes place, however, if the "Delay after bus voltage return" configured in the ETS has also elapsed.
- i** The mode of operation (summer/winter) can also be changed via the object while emergency operation is activated. In this case the room actuator adjusts the pulse-width modulation to the valve position value of the valid mode of operation immediately after the change-over.

Setting the telegram polarity for the alarm object for command value monitoring

The telegram polarity of the 1-bit object "Command value monitoring alarm" can be set separately for each valve output. The polarity can be configured on the parameter page "Ax Command value" (x = number of the valve output).

The cyclical command value monitoring must have been enabled already.

- Set the parameter "Polarity of 'Command value monitoring alarm' object" to "object value when command values absent = 0".
A fault in the command value monitoring (emergency operation is signalled by an "OFF" telegram (alarm). When the fault is reset (emergency operation terminated), an "ON" telegram is transmitted to the bus (no alarm).
- Set the parameter "Polarity of 'Command value monitoring alarm' object" to "object value when command values absent = 1".
A fault in the command value monitoring (emergency operation is signalled by an "ON" telegram (alarm). When the fault is reset (emergency operation terminated), an "OFF" telegram is transmitted to the bus (no alarm).

4.2.4.3 Priorities

Priorities

The room actuator distinguishes between different functions that can have an effect on an output. In order to prevent conflicting states, each available function has a certain priority. The function with the higher priority overrides the one with the lower priority.

For blinds operation there are the following priorities...

- 1st priority: manual control (highest priority)
- 2nd priority: forced position
- 3rd priority: safety function(s)

Priority levels 4 and 5 can be parameterized in the ETS only in blinds operation. The options are then...

- 4th priority: sun protection function
- 5th priority: direct operation via the bus (STEP/MOVE operation, positioning, scenes, central function)

or...

- 4th priority: direct operation via the bus (STEP/MOVE operation, positioning, scenes, central function)
- 5th priority: sun protection function

or...

- 4th priority: sun protection function and direct operation via the bus (STEP/MOVE operation, positioning, scenes, central function)

For switching operation there are the following priorities...

- 1st priority: manual control (highest priority)
- 2nd priority: forced position or disabling function
- 3rd priority: logic operation
- 4th priority: direct operation via the bus ("switching" object, scenes, central function)

For the valve outputs (electronic switching outputs) there are the following priorities...

- 1st priority: short-circuit / overload (highest priority)
- 2nd priority: manual control
- 3rd priority: anti-sticking protection
- 4th priority: forced position via object
- 5th priority: direct operation via the bus (command value evaluation) / emergency operation

4.2.4.4 State as supplied

State as supplied

In the state of the actuator as supplied the device behaves passively, i.e. no telegrams are transmitted to the bus. The outputs can, however, be operated by manual control on the device, if the mains voltage is on. In the manual control mode, no feedback telegrams are sent to the bus. Other functions of the actuator are deactivated.

The device can be programmed and put into operation with the ETS. The physical address is preset to 15.15.255

Moreover the device has been configured at the factory with the following characteristics...

- Channel definition: Outputs A1...A4 configured to blinds operation / A5 & A6 valve outputs
- Manual control in case of bus voltage failure: enabled
- Manual control during bus operation: enabled

For blind outputs...

- Travelling time (continuous run): 1 minute
- Travelling time extension 2 %
- Pause during travel direction change-over 1 s
- Behaviour in case of bus voltage failure: no reaction
- Behaviour after bus or mains voltage return: stop

For valve outputs...

- Valve direction of action (Valve in deenergized state): closed
- Behaviour in case of bus voltage failure: valve to value for emergency operation
- Behaviour after bus or mains voltage return: valve closes
- Value for emergency operation: 50 %
- PWM in manual control: 50 %
- Cycle time (PWM of the outputs): 15 minutes, 10 seconds
- no cyclical command value monitoring

4.2.5 Parameters

Description	Values	Comment
<p>☐ General</p>		
<p>Delay after bus voltage return Minutes (0...59)</p>	<p>0...59</p>	<p>To reduce telegram traffic on the bus line after bus voltage activation (bus reset), after connection of the device to the bus line or after programming with the ETS, it is possible to delay all active feedback telegrams of the actuator. The parameter specifies in this case a delay valid for all devices. Any feedback telegrams for bus initialisation will therefore be transmitted to the bus only after this parameterized time has elapsed.</p> <p>Sets the delay time minutes.</p>
<p>Seconds (0...59)</p>	<p>0...17...59</p>	<p>Sets the delay time seconds.</p>
<p>Alarm object for mains failure</p>	<p>disabled</p> <p>enabled</p>	<p>If the mains voltage of the actuator is not switched on, the switching states of the relay outputs and also of the electronic valve outputs can no longer be changed. So that a mains voltage failure on the actuator does not go undetected in the event of a fault, a mains failure message can be transmitted to the bus via the object "Mains failure alarm".</p> <p>The mains voltage monitoring is inactive.</p> <p>The mains voltage monitoring is activated.</p>
<p>☐ Channel definition</p>		
<p>Output 1 and output 2</p>	<p>1 x blind output</p> <p>2 x switching output</p>	<p>This parameter specifies the channel definition of the output pair A1 and A2.</p>
<p>Output 3 and output 4</p>	<p>1 x blind output</p> <p>2 x switching output</p>	<p>This parameter specifies the channel definition of the output pair A3 and A4.</p>
<p>☐ General switching outputs</p>		
<p>Time for cyclical monitoring Hours (0...23)</p>	<p>0...23</p>	<p>Optionally switching outputs can be assigned to the cyclical monitoring independently of each other. In this case, if after the monitoring time elapses no telegram update has been received on the "Switching" object, the corresponding output enters a predefined preferred position. The parameter "Time for cyclical monitoring" defines the monitoring time generally for all outputs.</p>

		Sets the monitoring time hours.
Minutes (0...59)	0... 2 ...59	Sets the monitoring time minutes.
Seconds (10...59)	10 ...59	Sets the monitoring time seconds. <i>Presetting: 2 minutes 10 seconds</i>
Time for cycl. transm. of the feedback Hours (0...23)	0 ...23	The switching status feedback telegrams of the actuator can, depending on their parameter settings, also transmit their state cyclically to the bus. The parameter "Time for cycl. transmission of the feedback" defines the cycle time generally for all switching outputs. Sets the cycle time hours.
Minutes (0...59)	0... 2 ...59	Sets the cycle time minutes.
Seconds (10...59)	10 ...59	Sets the cycle time seconds. <i>Presetting: 2 minutes 10 seconds</i>
Time for cycl. transm. of operating hours Hours (0...23)	0... 23	The operating hours counter of the switching outputs can, depending on the parameterization, also transmit their counter value cyclically to the bus. The parameter "Time for cycl. transm. of operating hours" defines the cycle time generally for all outputs. Sets the cycle time hours.
Minutes (0...59)	0 ...59	Sets the cycle time minutes.
Seconds (10...59)	10 ...59	Sets the cycle time seconds. <i>Presetting: 23 hours 0 minutes 10 seconds</i>
Central function for switching outputs	Yes No	Setting "Yes" enables the central function for the switching outputs and thus the "Central switching" object. Individual switching outputs can be assigned to the central function only if the function is enabled.

Central object polarity	<p>0 = switch off; 1 = switch on</p> <p>0 = switch on; 1 = switch off</p>	<p>This parameter defines the polarity of the central object "Central switching".</p> <p>i This parameter is visible only if the central switching function is enabled.</p>
Use centralized feedback for switching outputs ?	<p>No</p> <p>Yes, active signalling object Yes, passive status object</p>	<p>To keep the telegram load low during a 'bus initialisation', the centralized feedback function of the actuator can be employed. The setting "Yes" activates the centralized feedback for the outputs in switching operation and enables the corresponding object.</p> <p>The parameter moreover defines whether the feedback telegrams are transmitted actively (telegram transmission in case of changes) or passively (telegram transmission only as a response to a 'Read' request). The communication flags of the object are automatically set by the ETS according to the setting.</p>
Time delay for feedback after bus voltage return ?	<p>Yes</p> <p>No</p>	<p>The centralized feedback telegram can be transmitted to the bus with a delay after bus voltage return or after programming with the ETS. Setting "Yes" activates the delay time of the centralized feedback in case of bus voltage return. The delay time is parameterized under "General" (see above).</p> <p>i This parameter is visible only if centralized feedback is enabled.</p>
Cyclic transmission of the centralized feedback ?	<p>Yes (transmission cyclically and when change)</p> <p>No (transmission only when change)</p>	<p>The object value of the centralized feedback can be transmitted cyclically.</p> <p>The feedback telegram is transmitted to the bus cyclically and when there is a change of state. The cycle time is parameterized under "Switching output times" generally for all feedback telegrams.</p> <p>The feedback telegram is transmitted to the bus only after state changes.</p> <p>i This parameter is visible only if centralized feedback is enabled.</p>
Time for flashing (all assigned switching outputs)	<p>1 s</p> <p>2 s</p> <p>5 s</p> <p>10 s</p>	<p>At the beginning and at the end of a disabling function (if used), switching outputs can also be parameterized as "flashing". In this case, the outputs change their switching state cyclically. The parameter "Time for flashing" defines the switch-on time and the switch-off time of a flashing output signal</p>

in general for all switching outputs.
 Example:
 Time for flashing = 1 s
 1 s on -> 1 s off -> 1 s on -> 1 s off ...

☐|General blind outputs

Central function for blind outputs?	Yes No	Setting "Yes" enables the central function for the blind outputs and thus the "Central travel control" object. Individual shutter outputs can be assigned to the central function only if the function is enabled.
Central object polarity	0 = UP; 1 = DOWN 0 = DOWN; 1 = UP	This parameter defines the polarity of the central object.
Safety functions	disabled enabled	If it is intended to make use of the 5 safety functions of the actuator and to parameterize them, the function must be enabled for all channels (setting: "enabled"). If the safety functions are deactivated (setting: "disabled"), any programmed assignment of individual shutter outputs to safety monitoring functions is not operational.
Wind alarm 1	disabled enabled	This parameter can be used to enable the first wind alarm and thus to enable the communication object (setting: "enabled"). If the first wind alarm is deactivated (setting: "disabled"), any programmed assignment of individual shutter outputs to wind alarm 1 is not operational.
Wind alarm 2	disabled enabled	This parameter can be used to enable the second wind alarm and thus to enable the communication object (setting: "enabled"). If the first wind alarm is deactivated (setting: "disabled"), any programmed assignment of individual shutter outputs to wind alarm 2 is not operational.
Wind alarm 3	disabled enabled	This parameter can be used to enable the third wind alarm and thus to enable the communication object (setting: "enabled"). If the third wind alarm is deactivated (setting: "disabled"), any programmed assignment of individual shutter outputs to wind alarm 3 is not operational.
Rain alarm	disabled enabled	This parameter can be used to enable the rain alarm and thus to enable the communication object (setting: "enabled"). If the rain alarm is deactivated (setting: "disabled"), any programmed assignment of individual shutter outputs to the rain alarm is not operational.
Frost alarm		

	disabled		This parameter can be used to enable the frost alarm and thus to enable the communication object (setting: "enabled"). If the frost alarm is deactivated (setting: "disabled"), any programmed assignment of individual shutter outputs to the frost alarm is not operational.
	enabled		
Priority of safety alarms	wind -> rain -> frost wind -> frost -> rain rain -> wind -> frost rain -> frost -> wind frost -> rain -> wind frost -> wind -> rain		This parameter defines the priority ranking of the individual safety alarms. Interpretation: high -> medium -> low. <ul style="list-style-type: none"> i The three wind alarms have the same priority with respect to one another. i The safety alarm enabling parameters and the priority parameter is only visible when the safety functions are enabled.
<input type="checkbox"/> Blind safety times			
Use wind alarm monitoring function ? (only if wind alarms are enabled!)	Yes No		If the wind alarms enabled under "Blind outputs safety" are to be monitored cyclically for incoming telegrams to the safety objects, the monitoring function must be activated here (setting: "Yes"). In the opposite case (setting: "No"), the objects are not monitored cyclically. <ul style="list-style-type: none"> i As soon as this monitoring function is activated, telegrams must be transmitted cyclically to all enabled wind alarm objects. i The monitoring function may only be activated if at least one wind alarm has been activated under "Safety".
Time for monitoring wind alarm Hours (0...23)	0...23		This parameter is used for programming the wind alarm monitoring time. Sets the monitoring time hours.
Minutes (1...59)	1... 25 ...59		Sets the monitoring time minutes. <i>Presetting: 25 minutes</i> <ul style="list-style-type: none"> i The cycle time of the transmitter should be less than half the parameterized monitoring time of the actuator. i The times can only be set if wind alarm monitoring is activated.
Use rain alarm monitoring function ?	Yes No		If the rain alarm enabled under "Safety" is to be monitored cyclically for incoming telegrams to the safety object, the monitoring function must be activated here (setting: "Yes").

		<p>In the opposite case (setting: "No"), the object is not monitored cyclically.</p> <ul style="list-style-type: none"> i As soon as this monitoring function is activated, telegrams must be transmitted cyclically to the enabled rain alarm object. i The parameter is only visible if the rain alarm has been enabled under "Blind outputs safety".
<p>Time for monitoring rain alarm Hours (0...23)</p>	<p>0...23</p>	<p>This parameter is used for parameterizing the wind alarm monitoring time.</p> <p>Sets the monitoring time hours.</p>
<p>Minutes (1...59)</p>	<p>1...2...59</p>	<p>Sets the monitoring time minutes.</p> <p><i>Presetting: 2 minutes</i></p> <ul style="list-style-type: none"> i The cycle time of the transmitter should be less than half the parameterized monitoring time of the actuator. i The times can only be set if rain alarm monitoring is activated.
<p>Use frost alarm monitoring function ?</p>	<p>Yes No</p>	<p>If the frost alarm enabled under "Safety" is to be monitored cyclically for incoming telegrams to the safety object, the monitoring function must be activated here (setting: "Yes"). In the opposite case (setting: "No"), the object is not monitored cyclically.</p> <ul style="list-style-type: none"> i As soon as this monitoring function is activated, telegrams must be transmitted cyclically to the enabled frost alarm object. i The parameter is only visible if the frost alarm has been enabled under "Blind outputs safety".
<p>Time for monitoring frost alarm Hours (0...23)</p>	<p>0...23</p>	<p>This parameter is used for parameterizing the frost alarm monitoring time.</p> <p>Sets the monitoring time hours.</p>
<p>Minutes (1...59)</p>	<p>1...2...59</p>	<p>Sets the monitoring time minutes.</p> <p><i>Presetting: 2 minutes</i></p> <ul style="list-style-type: none"> i The cycle time of the transmitter should be less than half the parameterized monitoring time of the actuator. i The times can only be set if frost alarm monitoring is activated.

☐-|General valve outputs

Behaviour of all valve outputs after ETS programming

This parameter can be used to set the state of the valve drives after ETS programming in common for the two valve outputs. The behaviour of the valve outputs can thus be configured independently of the behaviour after bus or mains voltage return.

Close valves

The actuator closes the connected valve drives completely after ETS programming.

Open valves

The actuator opens the connected valve drives completely after ETS programming.

Valves to value for forced position

The actuator sets the connected valve drives to the value for the forced position (0...100 %) configured in the ETS for each output. With the setting 0 % the output concerned is completely closed, with the setting 100 % completely open.

Valves to value for emergency operation

The actuator sets the connected valve drives to the value for the emergency operation (0...100 %) configured in the ETS for each output. With the setting 0 % the output concerned is completely closed, with the setting 100 % completely open.

i The energization of the valve outputs is always performed taking into account the valve direction of action preset for each output.

i With the settings 1...99 % for the forced position or emergency operation value, after ETS programming the actuator carries out PWM on the valve output concerned until a new command value is issued or a different function is specified. In this case the PWM is performed after ETS programming even for valve outputs with a switching command value (1 bit)!

Summer/winter mode change-over ?

For the forced position function and for emergency operation, constant valve position values (0...100 %) can be configured in the ETS separately for each output. If a forced position or emergency operation has been activated, the room actuator transmits the specified valve position to the valve outputs concerned by means of pulse-width modulation. For these functions in the room actuator it is possible to preset in the ETS different valve position values for summer and winter.

In order for the room actuator to distinguish between two summer and winter valve position values for the forced position function and emergency operation,

		mode of operation change-over must be enabled using this parameter.
	Yes	The mode of operation change-over for summer and winter mode is enabled. The 1-bit communication object "Summer/winter change-over" becomes visible in the ETS.
	No	The mode of operation change-over for summer and winter mode is disabled. Only one valve position value can be set in the ETS per output separately for the forced position function and for emergency operation.
Polarity of "Summer/winter change-over" object	Summer = 1 / Winter = 0 Summer = 0 / Winter = 1	The telegram polarity of the 1-bit communication object "Summer/winter change-over" can be set using this parameter. i This parameter is only visible if the summer/winter mode change-over is enabled.
Mode of operation after device reset	Winter mode Summer mode	The value of the communication object "Summer/winter change-over" is initialised automatically by the room actuator after ETS programming and after bus or mains voltage return. The initialisation value is configured using this parameter. i This parameter is only visible if the summer/winter mode change-over is enabled.
Status object "All valves closed"	disabled enabled	The room actuator can use a 1-bit status telegram to transmit to the bus the information that all valves are closed, i.e. that no heating or cooling energy is being demanded via the command values of both valve outputs. This parameter can be used to enable the status messaging function.
Polarity of "All valves closed" object	object value in case of "All valves closed" = 0 object value in case of "All valves closed" = 1	The telegram polarity of the 1-bit communication object "All valves closed" can be set using this parameter. i This parameter is only visible if the status object "All valves closed" is enabled.
Only for constant 1-byte valve outputs Feedback of the largest command value	disabled enabled	With some condensing furnaces, the information about the largest heating command value in the heating circuit may be necessary in order to determine the optimal inlet temperature for the heating circuit. Exclusively for valve outputs with a con-

		stant command value the actuator determines the largest 1-byte nominal command value in the actuator. The actuator can transmit this largest command value to the bus via a separate 1-byte communication object "Largest command value feedback". This parameter can be used to enable the feedback function.
Anti-sticking protection	disabled enabled	The actuator has an automatic anti-stick protection function in order to prevent "furring up" or sticking of a valve that has not been activated for a longer period. If it is enabled using this parameter, the anti-stick protection always takes effect simultaneously for both valve outputs.
□↔Valve output times		
Cycle time (PWM of the outputs) Minutes (0...20)	0... 15 ...20	The cycle time defines the switching frequency of a pulse-width modulated output signal. The variable adjustment capability of the cycle time in this parameter makes it possible to adapt it to the adjustment cycle times of the valve drives being used (time needed by the drive to move the valve from the completely closed position to the completely open position). The cycle time is defined in common for both valve outputs Sets the cycle time minutes.
Seconds (10...59)	10 ...59	Sets the cycle time seconds. <i>Presetting: 15 minutes 10 seconds</i>
Time for cycl. monitoring of the command values Minutes (1...59)	1... 30 ...59	The room actuator makes it possible to monitor the command value for each valve output. This monitoring checks whether command value telegrams have been received by the room actuator within a time interval defined using this parameter. If no telegrams are received during the monitoring time, the actuator activates the emergency operation and set the connected valve drives to an emergency operation valve position parameterized in the ETS. The cycle time is configured in common for both valve outputs <i>Presetting: 30 minutes</i>

☐ Manual control

Manual control in case of bus voltage failure	disabled enabled	This parameter can be used for programming whether manual control is to be possible (enabled) or deactivated in case of bus voltage failure.
Manual control during bus operation	disabled enabled	This parameter can be used for programming whether manual control is to be possible (enabled) or deactivated during bus operation (bus voltage on).
Disabling function ?	Yes No	Manual control can be disabled via the bus, even if it is already active. For this purpose, the disabling object can be enabled here. i This parameter is only visible if manual control is enabled during bus operation.
Polarity of disable object	0 = enabled; 1 = disabled 0 = disabled; 1 = enabled	This parameter defines the polarity of the disabling object. i This parameter is only visible if manual control is enabled during bus operation.
Transmit status ?	Yes No	The current state of manual control can be transmitted to the bus via a separate status object, if bus voltage is available (setting: "Yes"). i This parameter is only visible if manual control is enabled during bus operation.
Function and polarity of status object	0 = inactive; 1 = manual control active 0 = inactive; 1 = permanent manual control active	This parameter defines the information contained in the status object. The object is always "0", when the manual control mode is deactivated. The object is "1" when the manual control mode is active (temporary or permanent). The object is "1" only when the permanent manual control is active. i This parameter is only visible if manual control is enabled during bus operation.
Behaviour at the end of permanent manual control during bus operation	no change	The behaviour of the actuator at the end of permanent manual control depends on this parameter. All telegrams received during an active permanent manual control mode for direct operation (switching, MOVE/STEP, positioning, central, scenes, command value telegrams) will be rejected. After the end of the permanent manual control mode, the state of all outputs that were last current in manual control remains unchanged. If, however, a forced posi-

		<p>tion, a disabling function, a safety function or a sun protection function (independent of priority) has been activated via the bus before or during manual control, the actuator executes these functions with a higher priority for the outputs concerned.</p>
	<p>output tracking</p>	<p>During active permanent manual control all incoming telegrams are tracked internally. At the end of manual control, the outputs are adjusted to the tracked states. The individual priorities of the functions with respect to one another are taken into account here; in each case only the function with the higher priority is executed.</p> <p>i This parameter is only visible if manual control is enabled during bus operation.</p>
<p>Bus control of individual outputs can be disabled during bus operation</p>	<p>Yes No</p>	<p>Individual outputs can be disabled locally during permanent manual control so that the disabled outputs can no longer be controlled via the bus. Disabling by means of manual control is only permitted if this parameter is set to "Yes".</p> <p>i This parameter is only visible if manual control is enabled during bus operation.</p>
<p>Only for valve outputs: PWM in manual control (1...100 %)</p>	<p>1...50...100</p>	<p>If valve outputs are to be opened during temporary or permanent manual control, the carries out pulse-width modulation (PWM) on the valve outputs concerned. This is also always done for valve outputs that are configured in the ETS as switching (command value 1 bit). This parameter is used to configure the pulse/pause ratio of the PWM specially for manual control in common for both outputs. The cycle time of the PWM is defined independent of the channel on the parameter page "Valve output times".</p> <p>i A special feature is that for manual control the PWM can be configured to 100 %. In this case the command "open valve" opens the valve permanently without carrying out pulse-width modulation. Consequently a button command "close valve" closes the valve output permanently. In this case, too the activation of the outputs is performed taking into account the configured valve direction of action for each valve output.</p>

□-Ax – General (x = number of the output pair 1/2 ... 3/4 in blinds operation / Only visible in blinds operation!)

Mode of operation (to be adjusted first!)	<p>blind</p> <p>shutter / awning</p> <p>venting louver</p>	<p>In blinds operation the actuator can be used to control different drive systems. This parameter defines which type of drive or which type of curtain is connected to the output.</p> <p>i The ETS adapts all of the following parameters (designations, visible/non visible, etc.) dynamically to the respective "mode of operation" parameter. For this reason, the "Mode of operation" parameter should be adjusted before all other parameters of an output.</p>
Behaviour after ETS programming	<p>raising / opening the louver</p> <p>lowering / closing the louver</p> <p>stop</p>	<p>The actuator permits setting the preferred relay contact position after ETS programming separately for each output.</p> <p>After programming with the ETS, the actuator raises the curtain or opens the venting louver.</p> <p>After programming with the ETS, the actuator lowers the curtain or closes the venting louver.</p> <p>After programming with the ETS, the actuator switches the relays of the output to the "stop" position. A travel movement, if any, will be interrupted.</p> <p>i The parameterized behaviour will be executed after every application or parameter download by the ETS. A simple download of the physical address alone or partial programming of only the group addresses has the effect that this parameter is disregarded and that the parameterized "Behaviour after bus/mains voltage-return" will be executed instead.</p>
Behaviour in case of bus voltage failure	<p>stop</p> <p>raising / opening the louver</p> <p>lowering / closing the louver</p> <p>approach position</p>	<p>The actuator permits setting the preferred relay contact position in case of bus voltage failure separately for each output.</p> <p>In case of bus voltage failure, the actuator switches the relays of the output to the "stop" position. A travel movement, if any, will be interrupted.</p> <p>After bus voltage failure, the actuator raises the curtain or opens the venting louver.</p> <p>After bus voltage failure, the actuator lowers the curtain or closes the venting louver.</p>

	no reaction	<p>In case of bus voltage failure, the connected drive can approach a position specified by further parameters.</p>
<p>Position of blind in case of bus voltage failure (0...100%)</p>	0...100	<p>In the event of bus voltage failure, the relay of the output shows no reaction. Any travel movements still in progress at the time of failure will be completely finished.</p> <p>i The parameterized behaviour will only be executed, if no manual control is activated.</p> <p>This parameter specifies the blind position to be approached in case of bus voltage failure.</p> <p>i This parameter is only visible if "Behaviour in case of bus voltage failure" is set to "approach position".</p> <p>i This parameter is visible only in the 'Blind' mode of operation.</p>
<p>Position of slat in case of bus voltage failure (0...100%)</p>	0...100	<p>This parameter specifies the slat position to be approached in case of bus voltage failure after the blind has been positioned at the desired height.</p> <p>i This parameter is only visible if "Behaviour in case of bus voltage failure" is set to "approach position".</p> <p>i This parameter is visible only in the 'Blind' mode of operation.</p>
<p>Position of shutter/awning in case of bus voltage failure (0...100%)</p>	0...100	<p>This parameter specifies the shutter or awning position to be approached in case of bus voltage failure.</p> <p>i This parameter is only visible if "Behaviour in case of bus voltage failure" is set to "approach position".</p> <p>i This parameter is visible only in the 'Shutter/awning' mode of operation.</p>
<p>Position of venting louver in case of bus voltage failure (0...100%)</p>	0...100	<p>This parameter specifies the venting louver position to be approached in case of bus voltage failure.</p> <p>i This parameter is only visible if "Behaviour in case of bus voltage failure" is set to "approach position".</p> <p>i This parameter is visible only in the 'Venting louver' mode of operation.</p>
<p>Behaviour after bus or mains voltage return</p>		<p>The actuator permits setting the preferred relay contact position after mains voltage return separately for each out-</p>

		put. This means that the parameterized behaviour is executed when either the bus or the mains voltage is switched on again.
	stop	In case of bus or mains voltage return, the actuator switches the relays of the output to the "stop" position. A travel movement, if any, will be interrupted.
	raising / opening the louver	After bus or mains voltage return, the actuator raises the curtain or opens the venting louver.
	lowering / closing the louver	After bus or mains voltage return, the actuator lowers the curtain or closes the venting louver.
	position in case of bus/ mains failure	After bus or mains voltage return, the state last existing and internally stored <u>before</u> bus or mains voltage failure will be tracked.
	approach position	In case of bus or mains voltage return, the connected drive can approach a position specified by further parameters.
position of blind on re- turn of bus/mains voltage (0...100%)	0...100	<p>This parameter specifies the blind position to be approached in case of bus or mains voltage return.</p> <ul style="list-style-type: none"> i This parameter is only visible if "Behaviour in case of bus or mains-voltage return" is set to "approach position". i This parameter is visible only in the 'Blind' mode of operation.
position of slat on return of bus/mains voltage (0...100%)	0...100	<p>This parameter specifies the slat position to be approached in case of bus or mains voltage return after the blind has been positioned at the desired height.</p> <ul style="list-style-type: none"> i This parameter is only visible if "Behaviour in case of bus or mains-voltage return" is set to "approach position". i This parameter is visible only in the 'Blind' mode of operation.
position of shutter/awn- ing on return of bus/ mains voltage (0...100%)	0...100	<p>This parameter specifies the shutter or awning position to be approached in case of bus or mains voltage return.</p> <ul style="list-style-type: none"> i This parameter is only visible if "Behaviour in case of bus or mains-voltage return" is set to "approach position". i This parameter is visible only in the 'Shutter/awning' mode of operation.
	0...100	

Position of venting louver on return of bus/ mains voltage (0...100%)

This parameter specifies the venting louver position to be approached in case of bus or mains voltage return.

- i This parameter is only visible if "Behaviour in case of bus or mains-voltage return" is set to "approach position".
- i This parameter is visible only in the "Venting louver" mode of operation.

Travelling time extension for upward travel

2 %
3 %
4 %
5 %
6 %
7 %
8 %
9 %
10 %
12.5 %

The actuator prolongs all upward movements or all venting louver movements into the open position of blind outputs based on the time extension specified in this parameter. The time extension expressed in percent is the difference between the measured travelling time needed to reach the lower end position (completely closed position) and the time needed to reach the upper end position (completely open position).

Ax – Times (x = number of the output pair 1/2 ... 3/4 in blinds operation / Only visible in blinds operation!)

STEP operation

This parameter can be used to parameterize the reaction to a received STEP telegram.

No (only stop)

The drive will only be stopped if it is executing a travel movement at the time of telegram reception. There is no reaction if no travel movement is in progress.

Yes

STEP operation is started on reception of a STEP telegram when the drive is stationary. If the drive is in motion at the time of telegram reception, it will be stopped.

Time for STEP operation
Seconds (0...59)

This parameter defines the time for the STEP operation.

Sets the STEP operation seconds.

Milliseconds(0...99 x 10)

Sets the STEP operation milliseconds.

Presetting: 2 seconds

- i The time for the STEP operation should in no case exceed half the slat adjusting time.
- i This parameter is only visible if the parameter "STEP operation" is set to "Yes".

Blind travelling time
Minutes (0...19)

This parameter defines the travelling time of the blind. The time needed for a complete travel from the upper into the lower end position must be determined.

		Sets the minutes of the blind travelling time.
Seconds (0...59)	0...59	Sets the seconds of the blind travelling time.
		<i>Presetting: 1 minute</i>
		<ul style="list-style-type: none"> i The travelling time must be determined precisely. i The travelling time parameters are only visible when the automatic end position detection is not enabled. i These parameters are visible only in the 'Blind' mode of operation.
Shutter/awning travelling time Minutes (0...59)	0...1...59	This parameter defines the travelling time of the shutter or awning. The time needed for a complete travel from the upper into the lower end position must be determined.
		Sets the minutes of the shutter or awning travelling time.
Seconds (0...59)	0...59	Sets the seconds of the shutter or awning travelling time.
		<i>Presetting: 1 minute</i>
		<ul style="list-style-type: none"> i The travelling time must be determined precisely. i The travelling time parameters are only visible when the automatic end position detection is not enabled. i These parameters are visible only in the 'Shutter/awning' mode of operation.
Venting louver travelling time Minutes (0...59)	0...1...59	This parameter defines the travelling time of the venting louver. The time needed for a complete travel from the completely open into the completely closed position must be determined.
		Sets the minutes of the venting louver travelling time.
Seconds (0...59)	0...59	Sets the seconds of the venting louver travelling time.
		<i>Presetting: 1 minute</i>
		<ul style="list-style-type: none"> i The travelling time must be determined precisely. i The travelling time parameters are only visible when the automatic end position detection is not enabled.

		<p>i These parameters are visible only in the 'Venting louver' mode of operation.</p>
Slat moving time Minutes (0...59)	0...59	<p>This parameter defines the moving time of the slats. The time needed for a complete movement from the completely open slat position into the completely closed slat position (downward direction) must be determined.</p> <p>Sets the minutes of the slat moving time.</p>
Seconds (0...59)	0...4...59	<p>Sets the seconds of the slat moving time.</p> <p><i>Presetting: 4 seconds</i></p> <p>i The travelling time must be determined precisely.</p> <p>i The slat moving time must be selected shorter than the blind travelling time.</p> <p>i These parameters are visible only in the 'Blind' mode of operation.</p>
Change-over time for travel direction changes	0.5 s 1 s 2 s 5 s	<p>Defines the pause for a travel direction change (change-over time).</p>
<p><input type="checkbox"/> Ax – Enabled functions (x = number of the output pair 1/2 ... 3/4 in blinds operation / Only visible in blinds operation!)</p>		
Feedback functions	disabled enabled	<p>This parameter can be used to disable or to enable the feedback functions. When the function is enabled, the required parameters will be displayed under "Ax –Feedbacks".</p>
Safety functions	disabled enabled	<p>This parameter can be used disable or to enable the safety functions. When the function is enabled, the required parameters will be displayed under "Ax –Safety".</p>
Sun protection functions	disabled enabled	<p>This parameter can be used disable or to enable the sun protection functions. When the function is enabled, the corresponding parameters will be displayed under "Ax Sun protection" (3 parameter nodes) and the necessary objects enabled.</p>
Scene function	disabled enabled	<p>This parameter can be used disable or to enable the scene function. When the function is enabled, the corresponding parameters will be displayed under "Ax Scenes" and the necessary objects enabled.</p>
Forced position function		

	<p>disabled</p> <p>enabled</p>	<p>This parameter can be used to disable or to enable the forced position function. When the function is enabled, the corresponding parameters will be displayed under "Ax - Forced position" and the necessary objects enabled.</p>
Fabric-stretching function	<p>disabled</p> <p>enabled</p>	<p>This parameter can be used to disable or to enable the fabric-stretching function. When the function is enabled, the corresponding parameters will be displayed under "Ax Fabric-stretching" and the necessary objects enabled.</p>
Assignment to central function ?	<p>Yes (enable central function under "General"!) No</p>	<p>This parameter determines the assignment of the output to the central function.</p> <p>The output is assigned to the central function. The central function must have been enabled under "General blind outputs". The assignment has otherwise no effect on the shutter output.</p> <p>The output is not assigned to the central function.</p>
<p>□ Ax – Feedbacks (x = number of output pair 1/2 ... 3/4 in blinds operation / Only visible in blinds operation and only accessible if the parameter "Feedback functions ?" under "Ax Enabled functions" is set to "enabled"!)</p>		
Blind position feedback	<p>no feedback</p> <p>feedback object is active signalling object</p> <p>feedback object is passive status object</p>	<p>The current blind position of the output can be reported separately back to the bus.</p> <p>No feedback object available for the output. Feedback deactivated.</p> <p>Feedback and object are activated. The object transmits actively (telegram transmission after change).</p> <p>Feedback and object are activated. The object is passive (telegram transmission only as a response to 'Read' request).</p> <p>i The communication flags of the object are automatically set by the ETS according to the setting.</p> <p>i This parameter is visible only in the 'Blind' mode of operation.</p>
Shutter/awning position feedback	<p>no feedback</p> <p>feedback object is active signalling object</p>	<p>The current shutter or awning position of the output can be reported separately back to the bus.</p> <p>No feedback object available for the output. Feedback deactivated.</p> <p>Feedback and object are activated. The object transmits actively (telegram transmission after change).</p>

<p>Venting louver position feedback</p>	<p>feedback object is passive status object</p>	<p>Feedback and object are activated. The object is passive (telegram transmission only as a response to 'Read' request).</p> <ul style="list-style-type: none"> i The communication flags of the object are automatically set by the ETS according to the setting. i This parameter is visible only in the 'Shutter/awning' mode of operation.
	<p>no feedback</p>	<p>The current venting louver position of the output can be reported separately back to the bus.</p> <p>No feedback object available for the output. Feedback deactivated.</p>
	<p>feedback object is active signalling object</p>	<p>Feedback and object are activated. The object transmits actively (telegram transmission after change).</p>
	<p>feedback object is passive status object</p>	<p>Feedback and object are activated. The object is passive (telegram transmission only as a response to 'Read' request).</p> <ul style="list-style-type: none"> i The communication flags of the object are automatically set by the ETS according to the setting. i This parameter is visible only in the 'Venting louver' mode of operation.
<p>Time delay for feedback after bus voltage return ?</p>	<p>Yes (delay time under "General")</p> <p>No</p>	<p>The feedback telegram can be transmitted to the bus with a delay after bus voltage return or after programming with the ETS. Setting "Yes" activates the feedback delay in case of bus voltage return. The delay time is parameterized under "General".</p> <ul style="list-style-type: none"> i This parameter is only visible in case of an actively transmitting feedback object.
<p>Slat position feedback</p>	<p>no feedback</p>	<p>The current slat position of the output can be reported separately back to the bus.</p> <p>No feedback object available for the output. Feedback deactivated.</p>
	<p>feedback object is active signalling object</p>	<p>Feedback and object are activated. The object transmits actively (telegram transmission after change).</p>
	<p>feedback object is passive status object</p>	<p>Feedback and object are activated. The object is passive (telegram transmission only as a response to 'Read' request).</p> <ul style="list-style-type: none"> i The communication flags of the object are automatically set by the ETS according to the setting. i This parameter is visible only in the 'Blind' mode of operation.
<p>Time delay for feedback after bus voltage return ?</p>	<p>Yes (delay time under "General")</p> <p>No</p>	<p>The feedback telegram can be transmitted to the bus with a delay after bus voltage return or after programming with the ETS. Setting "Yes" activates the feedback delay in case of bus voltage</p>

Invalid blind position feedback	<p>no feedback</p>	return. The delay time is parameterized under "General".
		<p>i This parameter is only visible in case of an actively transmitting feedback object.</p>
	feedback object is active signalling object	The actuator can report to the bus that the current blind position is unknown (e.g. after an initialisation, when no reference travel has been executed as yet).
	feedback object is passive status object	No feedback object available for the output. Feedback deactivated.
		Feedback and object are activated. The object transmits actively (telegram transmission after change).
		Feedback and object are activated. The object is passive (telegram transmission only as a response to 'Read' request).
		<p>i The communication flags of the object are automatically set by the ETS according to the setting.</p>
		<p>i This parameter is visible only in the 'Blind' mode of operation.</p>
Invalid shutter- awning position feedback	<p>no feedback</p>	The actuator can report to the bus that the current shutter/awning position is unknown (e.g. after an initialisation, when no reference travel has been executed as yet).
		No feedback object available for the output. Feedback deactivated.
	feedback object is active signalling object	Feedback and object are activated. The object transmits actively (telegram transmission after change).
	feedback object is passive status object	Feedback and object are activated. The object is passive (telegram transmission only as a response to 'Read' request).
		<p>i The communication flags of the object are automatically set by the ETS according to the setting.</p>
		<p>i This parameter is visible only in the 'Shutter/awning' mode of operation.</p>
Invalid venting louver position feedback	<p>no feedback</p>	The actuator can report to the bus that the current venting louver position is unknown (e.g. after an initialisation, when no reference travel has been executed as yet).
		No feedback object available for the output. Feedback deactivated.
	feedback object is active signalling object	Feedback and object are activated. The object transmits actively (telegram transmission after change).
	feedback object is passive status object	Feedback and object are activated. The object is passive (telegram transmission only as a response to 'Read' request).

Time delay for feedback after bus voltage return ?	Yes (delay time under "General")	<p>i The communication flags of the object are automatically set by the ETS according to the setting.</p>
	No	<p>i This parameter is visible only in the "Venting louver" mode of operation.</p>
Travel movement feedback	no feedback	<p>The feedback telegram can be transmitted to the bus with a delay after bus voltage return or after programming with the ETS. Setting "Yes" activates the feedback delay in case of bus voltage return. The delay time is parameterized under "General".</p>
	feedback object is active signalling object	<p>i This parameter is only visible in case of an actively transmitting feedback object.</p>
	feedback object is passive status object	<p>The actuator can report to the bus that the connected drive is active, i.e. the output is supplying power to the drive for a travel direction.</p>
Time delay for feedback after bus voltage return ?	Yes (delay time under "General")	<p>No feedback object available for the output. Feedback deactivated.</p>
	No	<p>Feedback and object are activated. The object transmits actively (telegram transmission after change).</p>
		<p>Feedback and object are activated. The object is passive (telegram transmission only as a response to 'Read' request).</p>
		<p>i The communication flags of the object are automatically set by the ETS according to the setting.</p>
		<p>The feedback telegram can be transmitted to the bus with a delay after bus voltage return or after programming with the ETS. Setting "Yes" activates the feedback delay in case of bus voltage return. The delay time is parameterized under "General".</p>
		<p>i This parameter is only visible in case of an actively transmitting feedback object.</p>
<p>☐Ax – Safety (x = Number of output pair 1/2 ... 3/4 in blinds operation / Only visible in blinds operation and only accessible if the parameter "Safety functions ?" under "Ax Enabled functions" is set to "enabled"!)</p>		
Assignment to wind alarms	No	<p>This parameter defines whether the output responds to a wind alarm and to which of the alarms.</p>
	Wind alarm 1	
	Wind alarm 2	
	Wind alarm 3	
	Wind alarm 1 + 2	
	Wind alarm 1 + 3	
	Wind alarm 2 + 3	

	Wind alarm 1 + 2 + 3	
Behaviour in case of wind alarm		This parameter defines the behaviour of the output at the beginning of a wind alarm.
	no reaction	At the beginning of the wind alarm or wind alarms, the output is interlocked and the relay of the output shows no reaction. Any travel movements in progress at this instant will still be completely finished.
	raising / opening the louver	The actuator raises the curtain or opens the venting louver at the beginning of the wind alarm or wind alarms and locks the output thereafter.
	raising / closing the louver	The actuator lowers the curtain or closes the venting louver at the beginning of the wind alarm or wind alarms and locks the output thereafter.
	stop	At the beginning of the wind alarm or wind alarms, the actuator switches the relays of the output to "stop" and locks the output. A travel movement, if any, will be interrupted.
		<p>i The behaviour preset in this parameter will be executed when one of the assigned wind alarms is activated.</p> <p>i This parameter is only visible if the output has been assigned to at least one wind alarm.</p>
Assignment to rain alarm	Yes	This parameter defines whether the output responds to the rain alarm.
	No	
Behaviour in case of rain alarm		This parameter defines the behaviour of the output at the beginning of the rain alarm.
	no reaction	At the beginning of the rain alarm, the output is interlocked and the relay of the output shows no reaction. Any travel movements in progress at this instant will still be completely finished.
	raising / opening the louver	The actuator raises the curtain or opens the venting louver at the beginning of the rain alarm and locks the output thereafter.
	raising / closing the louver	The actuator lowers the curtain or closes the venting louver at the beginning of the rain alarm and locks the output thereafter.
	stop	At the beginning of the rain alarm, the actuator switches the relays of the output to "stop" and locks the output. A

		travel movement, if any, will be interrupted.
		i This parameter is only visible if the output has been assigned to the rain alarm.
Assignment to frost alarm	Yes	This parameter defines whether the output responds to the frost alarm.
	No	
Behaviour in case of frost alarm		This parameter defines the behaviour of the output at the beginning of the frost alarm.
	no reaction	At the beginning of the frost alarm, the output is interlocked and the relay of the output shows no reaction. Any travel movements in progress at this instant will still be completely finished.
	raising / opening the louver	The actuator raises the curtain or opens the venting louver at the beginning of the frost alarm and locks the output thereafter.
	raising / closing the louver	The actuator lowers the curtain or closes the venting louver at the beginning of the frost alarm and locks the output thereafter.
	stop	At the beginning of the frost alarm, the actuator switches the relays of the output to "stop" and locks the output. A travel movement, if any, will be interrupted.
		i This parameter is only visible if the output has been assigned to the frost alarm.
Behaviour at the end of safety (wind, rain, frost)		This parameter defines the behaviour of the output at the end of all safety functions.
	no reaction	At the end of the safety functions, the output is enabled and the relay of the output shows no reaction. Any travel movements still in progress at this instant will still be finished.
	raising / opening the louver	The actuator enables the output at the end of all safety alarms and raises the curtain or opens the venting louver.
	raising / closing the louver	The actuator enables the output at the end of the safety functions and lowers the curtain or closes the venting louver.
	stop	At the end of the safety functions, the output is enabled and the actuator switches the relays of the output into the "stop" position. A travel movement, if any, will be interrupted.

<p>position tracking</p>	<p>At the end of safety, the output will be set to the state last adjusted before the safety function or to the state tracked and internally stored during the safety function. The position objects, the MOVE object and the scene function are tracked.</p> <p>i The behaviour preset in this parameter will only be executed, if the output passes over to direct operation at the end of safety. Direct operation will be executed when a sun protection function is active.</p>
<p>☐Ax – Sun protection (x = Number of output pair 1/2 ... 3/4 in blinds operation / Only visible in blinds operation and only accessible if the parameter "Sun protection functions ?" under "Ax Enabled functions" is set to "enabled"!)</p>	
<p>Type of sun protection</p>	<p>This parameter defines the scope of sun protection functions.</p>
<p>simple sun protection</p>	<p>Reduced scope of functions with standard configuration possibilities.</p>
<p>enlarged sun protection</p>	<p>Enlarged scope of functions including the possibilities of the simple sun protection. In addition, the connected drive can be integrated in shading control systems depending on the position of the sun. Automatic heating/cooling can also be realized.</p>
<p>Priority of sun protection with respect to direct operation</p>	<p>this parameter defines the priority of the sun protection function with respect to direct operation</p>
<p>same priority</p>	<p>The sun protection can be overridden by direct operation and vice versa. Only after the next reception of a "sun is shining" signal will the sun protection mode be activated again.</p>
<p>higher priority</p>	<p>The sun protection has the higher priority and cannot be aborted by a direct operation.</p>
<p>lower priority</p>	<p>The direct operation has the higher priority and cannot be aborted by a sun protection. The sun protection can be activated only after an enabling travel into the upper end position initiated by a direct operation has occurred without interruption.</p> <p>i Direct operation = MOVE/STEP operation; positioning via objects, scenes, central control.</p> <p>i This parameter is only visible in the simple sun protection.</p>

Priority of automatic operation with respect to direct operation

This parameter defines the priority of automatic operation with respect to direct operation. The selected priority affects the evaluation of the sunshine signal in the automatic mode and not the automatic mode itself.

same priority

The evaluation of the sunshine signal in the automatic mode can be overridden by a direct operation. In the same way, a direct operation is overridden by the reception of a new sunshine telegram.

higher priority

The automatic mode has the higher priority and cannot be aborted by a direct operation irrespective of the state of the sunshine signal. A direct operation will be possible again only after the automatic mode is terminated.

lower priority

The direct operation has the higher priority and cannot be aborted by a sunshine signal in the automatic mode. The sunshine signal is evaluated again only after an enabling travel into the upper end position initiated by a direct operation has occurred without interruption and only if the automatic mode is activated and not disabled at this time.

i Direct operation =
MOVE/STEP operation;
positioning via objects, scenes,
central control.

i This parameter is only visible in the enlarged sun protection.

Polarity of the "Sunshine / shading facade" object

sunshine = 1; no sunshine = 0

This parameter defines the polarity of the input object "Sunshine / shading facade" of the sun protection.

sunshine = 0; no sunshine = 1

Activation of automatic operation via...

This parameter defines how to activate the automatic mode and the reactions resulting from such activation.

object "Automatic" & next change of state

Automatic operation is activated as soon as the "Automatic" object is set to 'active' in depending on polarity. A reaction at the output occurs, however, only after a new change of state has been signalled via the "Sunshine / shading facade" object. In this case, the new state (beginning of sun protection or end of sun protection) determines the behaviour of the output.

object "Automatic" & immediate tracking

Automatic operation is activated as soon as the "Automatic" object receives a "1" telegram. The state of the object "Sunshine / shading facade" immediately determines the behaviour of the output (beginning of sun protection, end of sun protection).

Polarity of "Automatic" object	automatic mode: activated = 1; deactivated = 0	<p>i The reception of a telegram 'Automatic mode inactive' at the "Automatic" object immediately ends the automatic mode in both cases. The behaviour is in this case defined by the parameter "Reaction at the end of automatic operation".</p>
	automatic mode: activated = 0; deactivated = 1	This parameter defines the polarity of the automatic object.
		<p>i This parameter is only visible if the parameter "Activation of automatic operation - via..." is set to "object automatic" & next change of state".</p>
Disabling function for automatic mode ?	Yes	<p>The automatic mode can be disabled. When disabling is active, the automatic mode is aborted. It can only be reactivated if a "1" is written into the "Automatic" object. The objects "Automatic" and "Automatic mode disable" are logically combined (AND with feedback). "Yes" enables the disabling function and makes the disabling object visible.</p>
	No	
		<p>i This parameter is only visible if the parameter "Activation of automatic operation - via..." is set to "object automatic & immediate tracking".</p>
Polarity of "Automatic mode disable" object	Automatic mode: enabled = 1; disabled = 0	This parameter defines the polarity of the automatic mode disable object. Disabling is active when a telegram with polarity 'disabled' is received.
	Automatic mode: enabled = 0; disabled = 1	<p>i This parameter is only visible if the parameter "Disabling function for automatic mode ?" is set to "Yes".</p>
Disabling function for direct operation ?	Yes	<p>Direct operation can be disabled. When disabling is active, a direct operation can – independent of the preset priority – never override a sun protection function. In this case, direct operation is disabled in other functions, too. "Yes" enables the disabling function and makes the disabling object visible.</p>
	No	
		<p>i Direct operation = MOVE/STEP operation; positioning via objects, scenes, central control.</p>
Polarity of "Direct operation disable" object	Automatic mode: enabled = 1; disabled = 0	This parameter defines the polarity of the disabling object for direct operation. Disabling is active when a telegram with polarity 'disabled' is received.
	Automatic mode: enabled = 0; disabled = 1	

		<p>i This parameter is only visible if the parameter "Direct operation disable?" is set to "Yes".</p>
Reaction at the end of automatic operation		This parameter defines the behaviour of the output at the end of automatic operation and also at the beginning of an automatic operation disable.
	no reaction	At the end of automatic operation, the sun protection function is ended and the relay of the output shows no reaction. Any travel movements still in progress at this instant will still be finished.
	raising / opening the louver	At the end of automatic operation, the actuator terminates the sun protection and raises the curtain or opens the venting louver.
	raising / closing the louver	At the end of automatic operation, the actuator terminates the sun protection and lowers the curtain or closes the venting louver.
	stop	At the end of automatic operation the sun protection is terminated and the actuator switches the relays of the output to "stop". A travel movement, if any, will be interrupted.
	position tracking	At the end of automatic operation, the output will be set to the state last adjusted before the automatic sun protection or to the state tracked and internally stored during the automatic sun protection. The position objects, the MOVE object and the scene function are tracked.
		<p>i The behaviour preset in this parameter will only be executed, if no function with a higher priority (e.g. safety) is activated at the end of automatic operation.</p>
Time delay beginning of sunshine / shading Minutes (0...59)	0...59	The telegram received via the object "Sunshine / shading facade" for activation of shading (depending on polarity) can be evaluated with a time delay.
		Sets the delay time minutes.
Seconds (0...59)	0...30...59	Sets the delay time seconds.
		<i>Presetting: 30 seconds</i>
		<p>i A time setting of "0" in the parameters deactivates the respective delay time. In this case, the state of shading is evaluated immediately.</p>

Reaction at the beginning of sunshine / shading

no reaction	This parameter defines the behaviour of the output at the beginning of shading – if applicable, after the end of the delay time. At the beginning of shading, the output switches over to sun protection while the relays of the output show no reaction. Any travel movements still in progress at this instant will still be finished.
raising	At the beginning of shading, the actuator raises the curtain.
lowering	At the beginning of shading, the actuator lowers the curtain.
stop	At the beginning of shading, the actuator switches the relays of the output to the "stop" position. A travel movement, if any, will be interrupted.
internal scene recall	At the beginning of shading, the actuator recalls the position values preset in the scene configuration for the output concerned. This is not a scene recall as in direct operation, but only an approach of the corresponding scene position values.
fixed position of blind or slat	At the beginning of shading, the output controls the approach to a parameterized fixed blind and slat position.
fixed position of blind / variable position of slat	At the beginning of shading, the output controls the approach to a parameterized fixed blind position and to slat position preset by a separate object and thus variable.
fixed position of slat / variable position of blind	At the beginning of shading, the output controls the approach to a parameterized fixed slat position and to a blind position preset by a separate object and thus variable.
variable position of blind and slat	At the beginning of shading, the output controls the approach to the blind and slat positions preset by two separate objects and thus variable.

i This parameter is visible only in the 'Blind' mode of operation.

Reaction at the beginning of sunshine / shading

no reaction	This parameter defines the behaviour of the output at the beginning of shading – if applicable, after the end of the delay time. At the beginning of shading, the output switches over to sun protection while the relays of the output show no reaction. Any travel movements still in progress at this instant will still be finished.
raising	At the beginning of shading, the actuator raises the curtain.
lowering	

		At the beginning of shading, the actuator lowers the curtain.
	stop	At the beginning of shading, the actuator switches the relays of the output to the "stop" position. A travel movement, if any, will be interrupted.
	internal scene recall	At the beginning of shading, the actuator recalls the position values preset in the scene configuration for the output concerned. This is not a scene recall as in direct operation, but only an approach of the corresponding scene position values.
	fixed position of shutter / awning	At the beginning of shading, the output controls the approach to a parameterized fixed shutter / awning position.
	variable position of shutter / awning	At the beginning of shading, the output controls the approach to the shutter / awning position preset by a separate object and thus variable.
		i This parameter is visible only in the "Shutter / awning" mode of operation.
Reaction at the beginning of sunshine / shading		This parameter defines the behaviour of the output at the beginning of shading – if applicable, after the end of the delay time.
	no reaction	At the beginning of shading, the output switches over to sun protection while the relays of the output show no reaction. Any travel movements still in progress at this instant will still be finished.
	opening the louver	At the beginning of shading, the actuator opens the venting louver.
	closing the louver	At the beginning of shading, the actuator closes the venting louver.
	stop	At the beginning of shading, the actuator switches the relays of the output to the "stop" position. A travel movement, if any, will be interrupted.
	internal scene recall	At the beginning of shading, the actuator recalls the position values preset in the scene configuration for the output concerned. This is not a scene recall as in direct operation, but only an approach of the corresponding scene position values.
	fixed position of venting louver	At the beginning of shading, the output controls the approach to a parameterized fixed venting louver position.
	variable position of venting louver	At the beginning of shading, the output controls the approach to the venting louver position preset by a separate object and thus variable.

Scene number (1...8)	1...8	<p>i This parameter is visible only in the "Venting louver" mode of operation.</p> <p>This parameter defines the number of the internal scene which is recalled at the beginning of shading.</p>
Fixed position of blind	<p>as specified by parameter</p> <p>no change in current position</p>	<p>i This parameter is only visible if the parameter "Reaction at the beginning of sunshine / shading" is set to "internal scene recall".</p> <p>The fixed blind position at the beginning of shading can either be preset statically by a separate parameter or basically adjusted to the value prevailing at the time of shading activation, i.e. remain unchanged.</p> <p>At the beginning of shading, the parameterized blind position will be approached.</p> <p>At the beginning of shading, the current position of the blind will be maintained. In this case, the output behaves as if only the slat were positioned as a result of shading.</p>
Position of blind (0...100 %)	0... 50 ...100	<p>i This parameter is only visible if the blind is to approach a fixed position at the beginning of shading.</p> <p>i This parameter is visible only in the 'Blind' mode of operation.</p> <p>This parameter sets the fixed position of the blind to be approached at the beginning of shading.</p> <p>i This parameter is only visible if the parameter "Fixed position of blind" is set to "as specified by parameter".</p>
Fixed position of slat (0...100 %)	0... 50 ...100	<p>i This parameter is visible only in the 'Blind' mode of operation.</p> <p>This parameter sets the fixed position of the slat to be approached at the beginning of shading and, as the case may be, after positioning of the blind.</p> <p>i This parameter is only visible if the slat is to approach a fixed position at the beginning of shading.</p>
Fixed position of shutter / awning	<p>as specified by parameter</p>	<p>i This parameter is visible only in the 'Blind' mode of operation.</p> <p>The fixed position of the shutter or awning at the beginning of shading can either be preset statically by a separate parameter or basically adjusted to the value prevailing at the time of shading activation, i.e. remain unchanged.</p> <p>At the beginning of shading, the parameterized shutter / awning position will be approached.</p>

	no change in current position	At the beginning of shading, the current position of the shutter or awning will be maintained. Any travel movements in progress at the time of shading activation will be finished.
		<p>i This parameter is only visible if the shutter or awning is to approach a fixed position at the beginning of shading.</p> <p>i This parameter is visible only in the "Shutter / awning" mode of operation.</p>
Position of shutter / awning (0...100 %)	0... 50 ...100	<p>This parameter sets the fixed position of the shutter or awning to be approached at the beginning of shading.</p> <p>i This parameter is only visible if the parameter "Fixed position of shutter / awning" is set to "as specified by parameter".</p> <p>i This parameter is visible only in the "Shutter / awning" mode of operation.</p>
Fixed position of venting louver	as specified by parameter	<p>The fixed venting louver position at the beginning of shading can either be preset statically by a separate parameter or basically adjusted to the value prevailing at the time of shading activation, i.e. remain unchanged.</p> <p>At the beginning of shading, the parameterized venting louver position will be approached.</p>
Position of venting louver (0...100 %)	no change in current position	<p>At the beginning of shading, the current position of the venting louver will be maintained. Any travel movements in progress at the time of shading activation will be finished.</p> <p>i This parameter is only visible if the venting louver is to approach a fixed position at the beginning of shading.</p> <p>i This parameter is visible only in the "Venting louver" mode of operation.</p> <p>This parameter sets the fixed position of the venting louver to be approached at the beginning of shading.</p> <p>i This parameter is only visible if the parameter "Fixed position of venting louver" is set to "as specified by parameter".</p> <p>i This parameter is visible only in the "Venting louver" mode of operation.</p>
Reference travel before every sun protection positioning operation ?	Yes No	<p>A forced reference travel of the drive is performed before sun protection positioning (setting "yes"). A reference travel is a positioning movement into the upper end position or into the completely open position. By means of a forced reference</p>

Offset with fixed and variable slat position

travel, drives connected to different outputs can be synchronized. If no synchronizing movement is forced (setting "no"), the actuator performs a reference travel only once after return of the power supply.

no offset

For 'manual' readjustment of the slat angle during a shading or sun position tracking operation, a slat offset can be preset. The offset corrects the preset slat angle in positive or in negative direction. The lighting conditions in a room can thus be individually adapted by persons present in the room.

The offset correction is deactivated.

offset as parameterized

The slat offset is statically preset by means of a fixed parameter value.

offset as parameterized and via object

The slat offset is preset by a fixed parameter value and can be dynamically adapted via a separate communication object.

i This parameter is only visible if the slat is to approach a fixed or a variable position at the beginning of shading.

i This parameter is visible only in the 'Blind' mode of operation.

Offset slat position (-100..100 %)

-100...0...100

This parameter is used for setting the slat offset. The value specified in this parameter is added at the beginning of shading to the current slat angle.

i Even with offset correction, the 0...100% slat position limits cannot be overstepped.

i It should be noted that the parameterized offset value can be overwritten by the object after reception of a dynamical value.

i This parameter is only visible if the parameter "Offset with fixed and variable slat position" is set to "Offset as parameterized" or to "Offset as parameterized and via object".

i This parameter is visible only in the 'Blind' mode of operation.

Store offset slat position via object in case of bus voltage failure ?"

Yes

If the offset is preset via the object, this parameter defines whether the received value is to be stored in the actuator's NV memory.

The value received via the object will be stored permanently in the actuator in case of bus or mains voltage failure. The originally parameterized offset value is definitely overwritten in the process.

	No	<p>The value received via the object will only be stored temporarily in volatile memory. Thus, the value received via the object replaces the parameterized value only until the actuator is re-initialised (return of bus or mains voltage, if both voltages were off beforehand). After the initialisation, the offset value parameterized in the ETS will be used again.</p> <ul style="list-style-type: none"> <li data-bbox="976 553 1488 707"> i This parameter is only visible if the parameter "Offset with fixed and variable slat position" is set to "offset as parameterized and via object". <li data-bbox="976 714 1488 776"> i This parameter is visible only in the 'Blind' mode of operation.
<p>Time delay end of sunshine / shading Minutes (0...59)</p>	0...59	<p>The telegram received via the object "Sunshine / shading facade" for deactivation of shading (depending on polarity) can be evaluated with a time delay.</p>
Seconds (0...59)	0... 30 ...59	<p>Sets the delay time minutes.</p> <p>Sets the delay time seconds.</p> <p><i>Presetting: 30 seconds</i></p> <ul style="list-style-type: none"> <li data-bbox="976 1138 1488 1258"> i A time setting of "0" in the parameters deactivates the respective delay time. In this case, the state of shading is evaluated immediately.
<p>Reaction at the end of sunshine / shading</p>	no reaction	<p>This parameter defines the behaviour of the output at the end of shading – if applicable, after the end of the delay time.</p> <p>At the end of shading, the output quits the sun protection mode and the relays of the output show no reaction. Any travel movements still in progress at this instant will still be finished.</p>
	raising / opening the louver	<p>At the end of shading, the actuator raises the curtain or opens the venting louver.</p>
	lowering / closing the louver	<p>At the end of shading, the actuator lowers the curtain or closes the venting louver.</p>
	stop	<p>At the end of shading, the actuator switches the relays of the output to the "stop" position. A travel movement, if any, will be interrupted.</p> <ul style="list-style-type: none"> <li data-bbox="976 1958 1488 2103"> i The behaviour preset in this parameter will only be executed if no function with a higher priority (e.g. safety) is activated at the end of shading.

		<p>i This parameter is only visible in the simple sun protection.</p>
	position tracking	<p>At the end of shading, the output will be set to the state last adjusted before sun protection or to the state tracked and internally stored during sun protection. The position objects, the MOVE object and the scene function are tracked.</p>
Reaction at the end of sunshine / shading		<p>This parameter defines the behaviour of the output at the end of shading – if applicable, after the end of the delay time.</p>
	no reaction	<p>At the end of shading, the relays of the output show no reaction. Any travel movements still in progress at this instant will still be finished.</p>
	raising	<p>At the end of shading, the actuator raises the curtain.</p>
	lowering	<p>At the end of shading, the actuator lowers the curtain.</p>
	stop	<p>At the end of shading, the actuator switches the relays of the output to the "stop" position. A travel movement, if any, will be interrupted.</p>
	internal scene recall	<p>At the end of shading, an internal scene of the actuator is recalled.</p>
	fixed position of blind or slat	<p>At the end of shading, the output moves to a parameterized fixed blind and slat position.</p> <p>i This parameter is only visible in the enlarged sun protection.</p> <p>i This parameter is visible only in the 'Blind' mode of operation.</p> <p>i This parameter does not define the behaviour of the output at the end of automatic operation (cf. parameter "Reaction at the end of automatic operation")!</p>
Reaction at the end of sunshine / shading		<p>This parameter defines the behaviour of the output at the end of shading – if applicable, after the end of the delay time.</p>
	no reaction	<p>At the end of shading, the relays of the output show no reaction. Any travel movements still in progress at this instant will still be finished.</p>
	raising	<p>At the end of shading, the actuator raises the curtain.</p>
	lowering	<p>At the end of shading, the actuator lowers the curtain.</p>
	stop	<p>At the end of shading, the actuator switches the relays of the output to the "stop" position. A travel movement, if any, will be interrupted.</p>
	internal scene recall	<p>At the end of shading, an internal scene of the actuator is recalled.</p>

	fixed position of shutter / awning	<p>At the end of shading, the output moves to a parameterized fixed shutter / awning position.</p> <ul style="list-style-type: none"> i This parameter is only visible in the enlarged sun protection. i This parameter is visible only in the "Shutter / awning" mode of operation. i This parameter does not define the behaviour of the output at the end of automatic operation (cf. parameter "Reaction at the end of automatic operation")!
Reaction at the end of sunshine / shading		<p>This parameter defines the behaviour of the output at the end of shading – if applicable, after the end of the delay time.</p>
	no reaction	<p>At the end of shading, the relays of the output show no reaction. Any travel movements still in progress at this instant will still be finished.</p>
	opening the louver	<p>At the end of shading, the actuator opens the venting louver.</p>
	closing the louver	<p>At the end of shading, the actuator closes the venting louver.</p>
	stop	<p>At the end of shading, the actuator switches the relays of the output to the "stop" position. A travel movement, if any, will be interrupted.</p>
	internal scene recall	<p>At the end of shading, an internal scene of the actuator is recalled.</p>
	fixed position of venting louver	<p>At the end of shading, the output moves to a parameterized fixed venting louver position.</p> <ul style="list-style-type: none"> i This parameter is only visible in the enlarged sun protection. i This parameter is visible only in the "Venting louver" mode of operation. i This parameter does not define the behaviour of the output at the end of automatic operation (cf. parameter "Reaction at the end of automatic operation")!
Scene number (1...8)	1...8	<p>This parameter defines the number of the internal scene which is recalled at the end of shading.</p> <ul style="list-style-type: none"> i This parameter is only visible if the parameter "Reaction at the end of sunshine / shading" is set to "internal scene recall".
Fixed position of blind		<p>The fixed blind position at the end of shading can either be preset statically by a separate parameter or basically remain at the value set or tracked by the shading operation.</p>

as specified by parameter

		At the end of shading, the parameterized blind position will be approached.
	no change in current position	At the end of shading, the current position of the blind will be maintained. In this case, the output behaves as if only the slat were positioned as a result of the end of shading.
		<ul style="list-style-type: none"> i This parameter is only visible if the blind is to approach a fixed position at the end of shading. i This parameter is visible only in the 'Blind' mode of operation.
Position of blind (0...100 %)	0... 50 ...100	<p>This parameter sets the fixed position of the blind to be approached at the end of shading.</p> <ul style="list-style-type: none"> i This parameter is only visible if the parameter "Fixed position of blind" is set to "as specified by parameter". i This parameter is visible only in the 'Blind' mode of operation.
Fixed position of slat (0...100 %)	0... 50 ...100	<p>This parameter sets the fixed position of the slat to be approached at the end of shading and, as the case may be, after positioning of the blind.</p> <ul style="list-style-type: none"> i This parameter is only visible if the slat is to approach a fixed position at the beginning of shading. i This parameter is visible only in the 'Blind' mode of operation.
Fixed position of shutter / awning		<p>The fixed position of the shutter or awning at the end of shading can either be preset statically by a separate parameter or basically adjusted to the value prevailing at the time of shading activation, i.e. remain unchanged.</p>
	as specified by parameter	At the end of shading, the parameterized shutter / awning position will be approached.
	no change in current position	At the end of shading, the current position of the shutter or awning will be maintained. Any travel movements in progress at the time of shading activation will be finished.
		<ul style="list-style-type: none"> i This parameter is only visible if the shutter or awning is to approach a fixed position at the end of shading. i This parameter is visible only in the "Shutter / awning" mode of operation.
Position of shutter / awning (0...100 %)	0... 50 ...100	<p>This parameter sets the fixed position of the shutter or awning to be approached at the end of shading.</p>

Fixed position of venting louver	as specified by parameter	<p>i This parameter is only visible if the parameter "Fixed position of shutter / awning" is set to "as specified by parameter".</p> <p>i This parameter is visible only in the "Shutter / awning" mode of operation.</p> <p>The fixed venting louver position at the end of shading can either be preset statically by a separate parameter or basically adjusted to the value prevailing at the time of shading activation, i.e. remain unchanged.</p>
	no change in current position	<p>At the end of shading, the parameterized venting louver position will be approached.</p> <p>At the end of shading, the current position of the venting louver will be maintained. Any travel movements in progress at the time of shading activation will be finished.</p>
Position of venting louver (0...100 %)	0... 50 ...100	<p>i This parameter is only visible if the venting louver is to approach a fixed position at the end of shading.</p> <p>i This parameter is visible only in the "Venting louver" mode of operation.</p> <p>This parameter sets the fixed position of the venting louver to be approached at the end of shading.</p> <p>i This parameter is only visible if the parameter "Fixed position of venting louver" is set to "as specified by parameter".</p> <p>i This parameter is visible only in the "Venting louver" mode of operation.</p>
<p><input type="checkbox"/> Ax – Automatic heating/cooling (x = number of the output pair 1/2 ...3/4 in blinds operation / Only visible if the parameter "Sun protection functions ?" under "Ax Enabled functions" is set to "enabled" and the enlarged sun protection is parameterized!)</p>	<p>disabled</p> <p>enabled</p>	<p>This parameter can be used to activate the automatic heating/cooling function. The automatic function adds a presence detection function to the enlarged sun protection mode. If a person is present, the enlarged sun protection is executed as described. If nobody is present, however, the blinds, shutters, awnings or venting louvers can be operated in such a way that these devices support the heating or cooling function of the building. When the function is enabled, the other parameters and objects are enabled.</p> <p>i The automatic heating/cooling function can only be activated in the enlarged sun protection mode.</p>

Polarity of "Heating/cooling change-over" object	<p>no presence = 0; presence = 1</p> <p>cooling = 1; heating = 0</p>	<p>i Moreover, the automatic heating/cooling function is only active when the automatic mode of the enlarged sun protection function is activated.</p>
Polarity of "Heating/cooling presence" object	<p>cooling = 0; heating = 1</p> <p>no presence = 1; presence = 0</p>	<p>This parameter defines the polarity of the object for heating/cooling change-over. This object is linked, for instance, with room thermostats or outside thermometers.</p> <p>i After return of the power supply of the actuator, the heating/cooling change-over function is initialised with "0" in accordance with the polarity setting.</p> <p>i This parameter is visible only if automatic heating/cooling is enabled.</p> <p>This parameter defines the polarity of the presence control for automatic heating/cooling. This object is linked, for instance, with presence detectors.</p> <p>i After return of the power supply of the actuator, the heating/cooling presence control function is initialised with "0" in accordance with the polarity setting.</p> <p>i This parameter is visible only if automatic heating/cooling is enabled.</p>
Time delay at the beginning of presence Minutes (0...59)	<p>0...59</p>	<p>The telegram received via the object "Heating/cooling presence" for activation of the presence function (in acc. with polarity) can be evaluated with a time delay.</p>
Seconds (0...59)	<p>0...30...59</p>	<p>Sets the delay time minutes.</p> <p>Sets the delay time seconds.</p> <p><i>Presetting: 30 seconds</i></p> <p>i A time setting of "0" in the parameters deactivates the respective delay time. In this case, the state of the presence object is evaluated immediately.</p> <p>i These parameters are visible only if automatic heating/cooling is enabled.</p>
Time delay at the end of presence Minutes (0...59)	<p>0...59</p>	<p>The telegram received via the object "Heating/cooling presence" for deactivation of the presence function (in acc. with polarity) can be evaluated with a</p>

		time delay.
		Sets the delay time minutes.
Seconds (0...59)	0... 30 ...59	Sets the delay time seconds.
		<i>Presetting: 30 seconds</i>
		i A time setting of "0" in the parameters deactivates the respective delay time. In this case, the state of the presence object is evaluated immediately.
		i These parameters are visible only if automatic heating/cooling is enabled.
Reaction at the ... of sunshine / shading		This parameter defines the behaviour of the output at the end / at the beginning of sunshine / shading with heating / cooling – if applicable, after the end of the delay time.
Beginning for cooling *		
End for cooling *		
Beginning for heating *		
End for heating *		
	no reaction	The relays of the output show no reaction. Any travel movements still in progress at this instant will still be finished.
	raising	The actuator raises the curtain.
	lowering	The actuator lowers the curtain.
	internal scene recall	An internal scene of the actuator is recalled.
	fixed position of blind or slat	At the end of shading, the output moves to a parameterized fixed blind and slat position.
		i This parameter is visible only if automatic heating/cooling is enabled.
		i This parameter is visible only in the 'Blind' mode of operation.
		i *: The parameter settings for heating or cooling or beginning or end must be parameterized separately. The setting options - also for the follow-up parameters - are identical in all cases.
Reaction at the ... of sunshine / shading		This parameter defines the behaviour of the output at the end / at the beginning of sunshine / shading with heating / cooling – if applicable, after the end of the delay time.
Beginning for cooling *		
End for cooling *		

Beginning for heating *

End for heating *

no reaction

The relays of the output show no reaction. Any travel movements still in progress at this instant will still be finished.

raising

The actuator raises the curtain.

lowering

The actuator lowers the curtain.

internal scene recall

An internal scene of the actuator is recalled.

Fixed position of shutter / awning

The output moves to a parameterized fixed shutter or awning position.

i This parameter is visible only if automatic heating/cooling is enabled.

i This parameter is visible only in the "Shutter / awning" mode of operation.

i *: The parameter settings for heating or cooling or beginning or end must be parameterized separately. The setting options - also for the follow-up parameters - are identical in all cases.

Reaction at the ... of
sunshine / shading

This parameter defines the behaviour of the output at the end / at the beginning of sunshine / shading with heating / cooling – if applicable, after the end of the delay time.

Beginning for cooling *

End for cooling *

Beginning for heating *

End for heating *

no reaction

The relays of the output show no reaction. Any travel movements still in progress at this instant will still be finished.

opening the louver

The actuator opens the venting louver.

closing the louver

The actuator closes the venting louver.

internal scene recall

An internal scene of the actuator is recalled.

fixed position of venting
louver

At the end of shading, the output moves to a parameterized fixed venting louver position.

i This parameter is visible only if automatic heating/cooling is enabled.

		<p>i This parameter is visible only in the "Venting louver" mode of operation.</p> <p>i *: The parameter settings for heating or cooling or beginning or end must be parameterized separately. The setting options - also for the follow-up parameters - are identical in all cases.</p>
Scene number (1...8)	1...8	<p>This parameter defines the number of the internal scene which is recalled.</p> <p>i This parameter is only visible if the parameter "Reaction in case of sunshine / shading" of the automatic heating/cooling function is set to "internal scene recall".</p>
Fixed position of blind		<p>The fixed blind position in case of automatic heating/cooling can either be preset statically by a separate parameter or basically remain at the current value.</p>
	as specified by parameter	<p>The parameterized position of the blind will be approached.</p>
	no change in current position	<p>The current position of the blind will be maintained. In this case, the output behaves as if only the slat were positioned.</p> <p>i This parameter is only visible if the blind is to approach a fixed position in case of automatic heating/cooling.</p> <p>i This parameter is visible only in the 'Blind' mode of operation.</p>
Position of blind (0...100 %)	0... 50 ...100	<p>This parameter sets the fixed position of the blind to be approached in case of automatic heating/cooling.</p> <p>i This parameter is only visible if the parameter "Fixed position of blind" is set to "as specified by parameter".</p> <p>i This parameter is visible only in the 'Blind' mode of operation.</p>
Fixed position of slat (0...100 %)	0... 50 ...100	<p>This parameter sets the fixed position of the slat to be approached in case of automatic heating/cooling and, as the case may be, after positioning of the blind.</p> <p>i This parameter is only visible if the slat is to approach a fixed position with automatic heating/cooling.</p>

Fixed position of shutter / awning

i This parameter is visible only in the 'Blind' mode of operation.

The fixed shutter/awning position in case of automatic heating/cooling can either be preset statically by a separate parameter or basically remain at the current value.

as specified by parameter The parameterized shutter / awning position will be approached.

no change in current position The current shutter / awning position will be maintained.

i This parameter is only visible if the shutter or awning is to approach a fixed position in case of automatic heating/cooling.

i This parameter is visible only in the "Shutter / awning" mode of operation.

Position of shutter / awning (0...100 %)

0...**50**...100

This parameter sets the fixed position of the blind to be approached with automatic heating/cooling.

i This parameter is only visible if the parameter "Fixed position of shutter / awning" is set to "as specified by parameter".

i This parameter is visible only in the "Shutter / awning" mode of operation.

Fixed position of venting louver

The fixed venting louver position in case of automatic heating/cooling can either be preset statically by a separate parameter or basically remain at the current value.

as specified by parameter The parameterized venting louver position will be approached.

no change in current position The current position of the venting louver will be maintained.

i This parameter is only visible if the venting louver is to approach a fixed position in case of automatic heating/cooling.

i This parameter is visible only in the "Venting louver" mode of operation.

Position of venting louver (0...100 %)

0...**50**...100

This parameter sets the fixed position of the venting louver to be approached in case of automatic heating/cooling.

		<p>i This parameter is only visible if the parameter "Fixed position of venting louver" is set to "as specified by parameter".</p> <p>i This parameter is visible only in the "Venting louver" mode of operation.</p>
<p>□-Ax – Scenes (x = number of output pair 1/2 ... 3/4 in blinds operation / Only visible in blinds operation and only accessible if the parameter "Scene function" under "Ax Enabled functions" is set to "enabled"!)</p>		
Delay scene recall ?	<p>Yes</p> <p>No</p>	<p>A scene is recalled via the scene extension object. If needed, the scene recall on the actuator can be made with a delay after reception of a recall telegram (setting: "Yes"). The recall is alternatively made immediately on reception of the telegram (setting: "No").</p> <p>i A recall delay has no influence on the storage of scene values.</p>
Delay time Minutes (0...59)	0...59	<p>This parameter is used for programming the duration of the switch-on time for the staircase function.</p> <p>Sets the switch-on time minutes.</p>
Seconds (0...59)	0...10...59	<p>Sets the switch-on time seconds.</p> <p><i>Presetting: 10 seconds</i></p> <p>i The delay time parameters are only visible if the parameter "Delay scene recall ?" is set to "Yes".</p>
Overwrite values stored in the device during ETS download ?	<p>Yes</p> <p>No</p>	<p>During storage of a scene, the scene values (current states of the outputs concerned) are stored internally in the device. To prevent the stored values from being replaced during an ETS programming operation by the originally programmed scene states, the actuator can inhibit overwriting of the scene values (setting: "No"). As an alternative, the original values can be reloaded into the device during each ETS programming operation (setting: "Yes").</p>
Scene X activatable by scene number (scene number "0" = scene de- activated)	<p>0...1*...64</p> <p><i>*: The predefined scene number is dependent on the scene (1...8).</i></p>	<p>The actuator distinguishes between up to 8 different scenes which are recalled via the scene extension object or stored. The datapoint type of the extension object, however, permits addressing a maximum of 64 scenes. This parameter defines the scene number (1...64) which is used to address the internal scene (1...8). A setting of "0" deactivates the corresponding scene.</p>
<p><i>X = Depending on the scene (1...8)</i></p>		

<p>position of blind for scene X</p> <p><i>X = Depending on the scene (1...8)</i></p>	<p>0*...100</p> <p><i>*: The predefined position value is dependent on the scene (1...8).</i></p>	<p>This parameter is used for parameterizing the blind position which is executed when the scene is recalled.</p> <p>i This parameter is visible only in the 'Blind' mode of operation.</p>
<p>position of slat for scene X</p> <p><i>X = Depending on the scene (1...8)</i></p>	<p>0*...100</p> <p><i>*: The predefined position value is dependent on the scene (1...8).</i></p>	<p>This parameter is used for parameterizing the slat position which is executed when the scene is recalled.</p> <p>i This parameter is visible only in the 'Blind' mode of operation.</p>
<p>position of shutter/awning for scene X</p> <p><i>X = Depending on the scene (1...8)</i></p>	<p>0*...100</p> <p><i>*: The predefined position value is dependent on the scene (1...8).</i></p>	<p>This parameter is used for parameterizing the shutter or awning position which is executed when the scene is recalled.</p> <p>i This parameter is visible only in the 'Shutter/awning' mode of operation.</p>
<p>Position of venting louver for scene X</p> <p><i>X = Depending on the scene (1...8)</i></p>	<p>0*...100</p> <p><i>*: The predefined position value is dependent on the scene (1...8).</i></p>	<p>This parameter is used for parameterizing the venting louver position which is executed when the scene is recalled.</p> <p>i This parameter is visible only in the "Venting louver" mode of operation.</p>
<p>Storage function for scene X</p> <p><i>X = Depending on the scene (1...8)</i></p>	<p>Yes</p> <p>No</p>	<p>Setting "Yes" enables the storage function of the scene. If the function is enabled, the current position (0...100 %) can be stored internally via the extension object when a storage telegram is received. If "No" is selected, the storage telegrams are rejected.</p>
<p>□Ax – Forced position (x = number of output pair 1/2 ... 3/4 in blinds operation / Only visible in blinds operation and only accessible if the parameter "Forced position function" under "Ax Enabled functions" is set to "enabled!")</p>		
<p>Behaviour at the end of the forced position function</p>	<p>position tracking</p>	<p>The behaviour of the output at the beginning of a forced position function is directly determined by the forced position telegram. The behaviour of the output at the end of the forced position function can be parameterized.</p> <p>At the end of the forced position state, the output will be set to the position last existing before the forced position function or to the one tracked internally while the forced position function was active.</p>
	<p>no change</p>	<p>At the end of forced position state, the position last adjusted will not be</p>

Behaviour after bus voltage return

changed. Thereafter, the output is again enabled.

The communication object of the forced position function can be initialised after bus voltage return.

no forced position active

After bus voltage return, the forced position function is deactivated.

forced position on, raising / opening the louver

The forced position function is activated after bus voltage return and the curtain is raised or the venting louver opened.

forced position on, lowering / closing the louver

The forced position function is activated after bus voltage return and the curtain lowered or the venting louver closed.

state of forced position before bus/mains failure

After bus voltage return, the forced position state last selected and internally stored before bus or mains voltage failure will be tracked. An ETS programming operation deletes the stored state (reaction in that case same as with "no forced position active").

- i** This parameter is evaluated even after ETS programming of the application or of the parameters.
- i** The forced position parameters are only visible if the parameter "Forced position function" under "Ax Enabled functions" is set to "enabled".

☐Ax – Fabric-stretching (x = number of output pair 1/2 ... 3/4 in blinds operation / Only visible for "shutter/awning" and only accessible if the parameter "Fabric-stretching function" under "Ax Enabled functions" is set to "enabled"!)

Mode of operation

The relays of a switching output can be parameterized as NO or NC contacts. This feature makes it possible to invert the switching states.

NO contact

Switching state = off ("0") ->
Relay contact open
Switching state = on ("1") ->
Relay contact closed

NC contact

Switching state = off ("0") ->
Relay contact closed
Switching state = on ("1") ->
Relay contact open

☐Ax – General (x = number of the output A1 ... A4 in switching operation / Only visible in switching operation!)

Mode of operation

The relays of a switching output can be parameterized as NO or NC contacts. This feature makes it possible to invert the switching states.

NO contact

Switching state = off ("0") ->
Relay contact open

		Switching state = on ("1") -> Relay contact closed
	NC contact	Switching state = off ("0") -> Relay contact closed Switching state = on ("1") -> Relay contact open
Behaviour after ETS programming		The actuator permits setting the preferred relay contact position after ETS programming separately for each output.
	close contact	The relay contact is closed after ETS programming.
	open contact	The relay contact is opened after ETS programming.
	no reaction	After ETS programming the relay of the output shows no reaction and remains in the current switching state.
		i The parameterized behaviour will be executed after every application or parameter download by the ETS. A simple download of the physical address alone or partial programming of only the group addresses has the effect that this parameter is disregarded and that the parameterized "Behaviour after bus voltage return" will be executed instead.
Behaviour in case of bus voltage failure		The actuator permits setting the preferred relay contact position in case of bus voltage failure separately for each output.
	close contact	The relay contact is closed on bus voltage failure.
	open contact	The relay contact is opened on bus voltage failure.
	no reaction	In case of bus voltage failure the relay of the output shows no reaction and remains in the current switching state.
Behaviour after bus or mains voltage return		The actuator permits setting the preferred relay contact position after bus or mains voltage return separately for each output.
	close contact	The relay contact closes after bus or mains voltage return.
	open contact	The relay contact opens after bus or mains voltage return.
	state as before bus/mains voltage failure	After bus or mains voltage return, the switching state last existing and internally stored <u>before</u> bus or mains voltage failure will be tracked.

activate staircase function (if parameterized)		The staircase function is activated after bus or mains voltage return – independent of the object "Switching". In this setting it should be ensured that the staircase function is also enabled and configured appropriately. If the staircase function is not enabled, this setting will not show any reaction after bus return.
no reaction		<p>In the event of bus or mains voltage return, the relay of the output shows no reaction. Ongoing travel movements at the time of voltage return are completed.</p> <p>i The parameterized behaviour is only executed if the last ETS programming of the application or of the parameters was more than approx. 20 s in the past. Otherwise ($T_{ETS} < 20$ s) the "Behaviour after ETS programming" will be executed also in case of a bus voltage return.</p> <p>i It should be noted that after bus/ mains return a forced position may be activated that could influence the switching state of the output.</p>
Assignment to central function ?		This parameter determines the assignment of the output to the central function.
Yes (enable central function under "General"!)		The output is assigned to the central function. The switching central function must have been enabled under "General switching outputs". The assignment has otherwise no effect on the switching output.
No		The output is not assigned to the central function.
Feedback telegram ?		The current switching state of the output can be reported back separately to the bus.
none		No feedback object available for the output. Feedback deactivated.
no inversion, active signalling object		Feedback and object are activated. The state is transmitted in non-inverted form. The object transmits actively (telegram transmission after change).
no inversion, passive status object		Feedback and object are activated. The state is transmitted in non-inverted form. The object is passive (telegram transmission only as a response to 'Read' request).
inversion, active signalling object		Feedback and object are activated. The state is transmitted in inverted form. The object transmits actively (telegram transmission after change).

	inversion, passive status object	<p>Feedback and object are activated. The state is transmitted in inverted form. The object is passive (telegram transmission only as a response to 'Read' request.</p> <p>i The communication flags of the object are automatically set by the ETS according to the setting.</p>
Time delay for feedback after bus voltage return ?	<p>Yes (delay time under "General")</p> <p>No</p>	<p>The feedback telegram can be transmitted to the bus with a delay after bus voltage return or after programming with the ETS. Setting "Yes" activates the feedback delay in case of bus voltage return. The delay time is parameterized under "General".</p>
Cyclical transmission of the feedback ?	<p>Yes (transmission cyclically and when change)</p> <p>No (transmission only when change)</p>	<p>The object value of the feedback can be transmitted cyclically.</p> <p>The feedback telegram is transmitted to the bus cyclically and when there is a change of state. The cycle time is parameterized under "Times" generally for all feedback telegrams.</p> <p>The feedback telegram is transmitted to the bus only after state changes.</p>
<p><input type="checkbox"/> Ax – Enabled functions (x = number of the output A1 ... A4 in switching operation / Only visible in switching operation!)</p>	<p>Assignment to cyclical monitoring ?</p> <p>No</p> <p>Yes, "ON" when time has elapsed</p> <p>Yes, "OFF" when time has elapsed</p>	<p>This parameter determines the assignment to cyclical monitoring of the output.</p> <p>Cyclical monitoring deactivated.</p> <p>Cyclical monitoring activated. The actuator expects a telegram update to the "Switching" object within the monitoring time parameterized under "Times". Otherwise, the output will be brought into the predefined contact position and activated when the monitoring time has elapsed.</p> <p>Cyclical monitoring activated. The actuator expects a telegram update to the "Switching" object within the monitoring time parameterized under "Times". Otherwise, the output will be brought into the predefined contact position and deactivated when the monitoring time has elapsed.</p> <p>i An output in preferred contact position is not locked so that new telegram updates to the "Switching" object will again be evaluated and processed normally.</p>

- i** The disabling or forced position function has a higher priority than the cyclical monitoring function.
- i** When cyclical monitoring is activated, it is not possible to parameterize the functions delay times, staircase function, logic operation and scene.

Time delays	disabled enabled	This parameter can be used disable or to enable the time delays. When the function is enabled, the required parameters will be displayed under "Ax Time delays".
Staircase function	disabled enabled	This parameter can be used disable or to enable the staircase function. When the function is enabled, the corresponding parameters will be displayed under "Ax Staircase function" and the necessary objects enabled.
Scene function	disabled enabled	This parameter can be used disable or to enable the scene function. When the function is enabled, the corresponding parameters will be displayed under "Ax Scenes" and the necessary objects enabled.
Operating hours counter ?	disabled enabled	This parameter can be used disable or to enable the operating hours counter. When the function is enabled, the corresponding parameters will be displayed under "Ax Operating hours counter" and the necessary objects enabled. i Disabling of the operating hours counter will cause any operating hours counted beforehand to be deleted and limit or start values set via the object for the output concerned to be reset.

□ Ax – Time delays (x = number of the output A1 ... A4 in switching operation / Only visible in switching operation and only accessible if the parameter "Time delays ?" under "Ax – Enabled functions" is set to "enabled"!)

Selection of time delay	no time delay Switch-off delay Switch-on delay Switch-on and switch-off delay	The communication object "Switching" can be evaluated with a time delay. This parameter selects the desired mode of operation of the time delay and enables the other delay parameters.
-------------------------	---	---

Switch-on delay Hours (0...23)	0...23	This parameter is used for programming the duration of the switch-on delay
		Sets the switch-on delay hours.
Minutes (0...59)	0...59	Sets the switch-on delay minutes.
Seconds (0...59)	0...30...59	Sets the switch-on delay seconds.
		<i>Presetting: 30 seconds</i>
Switch-on delay retriggerable ?	Yes No	An active switch-on delay can be retriggered by another "1" telegram (setting "Yes"). Alternatively, retriggering can be suppressed (setting "No").
		i The switch-on delay parameters are only visible if the parameter "Selection of time delay" is set to "Switch-on delay" or to "Switch-on and switch-off delay".
Switch-off delay Hours (0...23)	0...23	This parameter is used for programming the duration of the switch-off delay
		Sets the switch-off delay hours.
Minutes (0...59)	0...59	Sets the switch-off delay minutes.
Seconds (0...59)	0...30...59	Sets the switch-off delay seconds.
		<i>Presetting: 30 seconds</i>
Switch-off delay retriggerable ?	Yes No	An active switch-off delay can be retriggered by another "0" telegram (setting "Yes"). Alternatively, retriggering can be suppressed (setting "No").
		i The switch-off delay parameters are only visible if the parameter "Selection of time delay" is set to "Switch-off delay" or to "Switch-on and switch-off delay".
<p><input type="checkbox"/> Ax – Staircase function (x = number of the output A1 ... A4 in switching operation / Only visible in switching operation, and only accessible if the parameter "Staircase function ?" under "Ax – Enabled functions" is set to "enabled"!)</p>		
Staircase time Hours (0...23)	0...23	This parameter is used for programming the duration of the switch-on time for the staircase function.
		Sets the switch-on time hours.
Minutes (0...59)	0...3...59	Sets the switch-on time minutes.
Seconds (0...59)	0...59	Sets the switch-on time seconds.
		<i>Presetting: 3 minutes</i>

Staircase time retriggerable ?	Yes	An active switch-on time can be retriggered (setting "Yes"). Alternatively, retriggering can be suppressed (setting "No"). i This parameter is fixed to "No" when the supplementary function "Time extension" is parameterized. In this case, retriggering is not possible.
	No	
Reaction to OFF-telegram	switch off	An active staircase lighting time can be stopped prematurely by deactivating the staircase lighting time. The staircase time is stopped after reception of an OFF-telegram to the "Staircase time start/stop" object. In the supplementary function "Time preset via the bus" with the setting "Activate staircase function via 'Staircase time' object ? = Yes", the staircase time can also be stopped prematurely by inserting a factor of "0".
	ignore	OFF-telegrams or factors of "0" will be ignored. The staircase time will be executed completely.
Supplementary function for staircase function		The staircase function can be enlarged by two supplementary functions to be used alternatively. This parameter enables the desired supplementary function and activates the necessary parameters or objects.
	no supplementary function	No supplementary function enabled.
	time extension	The time extension is activated. This function can be used to retrigger an activated staircase time n times via the object "Staircase function start/stop".
	time preset via the bus	Time preset via the bus is active. With this supplementary function, the parameterized staircase time can be multiplied with a factor received from the bus and thus dynamically adapted.
Maximum time extension	1-fold time	In a time extension (n-fold retriggering via the object "Staircase function start/stop"), when the parameterized staircase time elapses it will be extended by a maximum of the value parameterized here. "1-fold time" means that the started staircase time can be retriggered at maximum one more time after elapsing. The time is thus doubled. The other setting options apply analogously.
	2-fold time	
	3-fold time	
	4-fold time	
	5-fold time	

			<p>i This parameter is visible only when the supplementary function "Time extension" is set.</p>
Staircase function activatable via "Staircase time" object ?	<p>Yes</p> <p>No</p>		<p>In case of time preset via the bus, this parameter can be used to define whether the reception of a new time factor also starts the switch-on time of the staircase function as well (setting "Yes"). The object "Staircase function start/stop" is then blanked out. When the setting is "No", the switch-on time can only be activated via the object "Staircase function start/stop".</p> <p>i This parameter is visible only when the supplementary function "Time preset via the bus" is set.</p>
Activate switch-on delay for staircase function ?	<p>Yes</p> <p>No</p>		<p>The staircase function permits activating its own switch-on delay. This switch-on delay acts on the trigger event of the staircase function and therefore delays switching-on.</p> <p>The switch-on delay is activated.</p> <p>The switch-on delay is deactivated.</p> <p>i The switch-on delay parameterized under this item is independent of the other time functions of the actuator. It only acts on the staircase function and not on the "Switching" object.</p>
Switch-on delay Hours (0...23)	0...23		<p>This parameter is used for programming the duration of the switch-on delay</p> <p>Sets the switch-on delay hours.</p>
Minutes (0...59)	0...59		<p>Sets the switch-on delay minutes.</p>
Seconds (0...59)	0...30...59		<p>Sets the switch-on delay seconds.</p> <p><i>Presetting: 30 seconds</i></p>
Switch-on delay retriggerable ?	<p>Yes</p> <p>No</p>		<p>An active switch-on delay can be retriggered (setting "Yes"). Alternatively, retriggering can be suppressed (setting "No").</p> <p>i This parameter is fixed to "No" when the supplementary function "Time extension" is parameterized. In this case, retriggering is not possible.</p>

i The switch-on delay parameters are only visible if the parameter "Activate switch-on delay for staircase function ?" is set to "Yes".

Activate pre-warning time ?

Yes

After the switch-on time of a staircase function elapses, the output can generate pre-warnings before switching off. The pre-warning should warn any person still on the staircase that the light will be switched off soon.

The pre-warning function is activated.

No

The pre-warning function is deactivated.

Pre-warning time
Minutes (0...59)

0...59

This parameter is used for programming the duration of the pre-warning time. The pre-warning time is added to the switch-on time. Pre-warnings (switching the output off) are only generated within the pre-warning time.

Seconds (0...59)

0...**30**...59

Sets the pre-warning time minutes.

Sets the pre-warning time seconds.

Presetting: 30 seconds

i An active pre-warning time is aborted by retriggering of the staircase function.

Number of pre-warnings
(1...10)

1...**3**..10

This parameter defines how often the output is to switch off within the pre-warning time. i.e. how many pre-warnings will be generated.

Time for pre-warning interruptions
Seconds (0...59)

0...59

The duration of a pre-warning interruption is defined here, in other words how long the output should be switched off in case of a pre-warning interruption. This time should be adapted individually to the switch-off behaviour of the lamp type being used.

Sets the pre-warning interruption seconds.

Milliseconds
(0...9 x 100)

0...**5**...9

Sets the pre-warning interruption milliseconds.

Presetting: 500 milliseconds

i It must be ensured that the "Number of pre-warnings" and the "Time for pre-warning interruptions" are coordinated with the length of the total "pre-warning time". Thus, the total shut-off phase during a pre-warning ("Number of pre-warnings" + "Time for pre-warning interruptions") must not be chosen longer than the pre-warning time itself. Otherwise risk of malfunctions.

☐Ax – Scenes (x = number of the output A1 ... A4 in switching operation / Only visible in switching operation and only accessible if the parameter "Scene function ?" under "Ax – Enabled functions" is set to "enabled!")

Delay scene recall ?	<p>Yes</p> <p>No</p>	<p>A scene is recalled via the scene extension object. If needed, the scene recall on the actuator can be made with a delay after reception of a recall telegram (setting: "Yes"). The recall is alternatively made immediately on reception of the telegram (setting: "No").</p> <p>i A recall delay has no influence on the storage of scene values.</p>
Delay time Minutes (0...59)	0...59	<p>This parameter is used for programming the duration of the scene delay time.</p> <p>Sets the scene delay time minutes.</p>
Seconds (0...59)	0...10...59	<p>Sets the scene delay time seconds.</p> <p><i>Presetting: 10 seconds</i></p> <p>i The delay time parameters are only visible if the parameter "Delay scene recall ?" is set to "Yes".</p>
Overwrite values stored in the device during ETS download ?	<p>Yes</p> <p>No</p>	<p>During storage of a scene, the scene values (current states of the outputs concerned) are stored internally in the device. To prevent the stored values from being replaced during ETS programming by the originally programmed scene switching states, the actuator can inhibit overwriting of the scene values (setting: "No"). As an alternative, the original values can be reloaded into the device during each ETS programming operation (setting: "Yes").</p>
Scene X activatable by scene number (scene number "0" = scene de- activated)	<p>0...1*...64</p> <p>*: The predefined scene number is dependent on the scene (1...8).</p>	<p>The actuator distinguishes between up to 8 different scenes which are recalled via the scene extension object or stored. The datapoint type of the extension object, however, permits addressing a maximum of 64 scenes. This parameter defines the scene num-</p>
X = Depending on the scene (1...8)		

		ber (1...64) which is used to address the internal scene (1...8). A setting of "0" deactivates the corresponding scene.
Switching state in scene X	Switch on switch off	This parameter is used for programming the switching command which is executed when the scene is recalled.
X = Depending on the scene (1...8)		
Storage function for scene X	Yes No	Setting "Yes" enables the storage function of the scene. If the function is enabled, the current logic switching state (on / off) can be stored internally via the extension object when a scene storage telegram is received. If "No" is selected, the storage telegrams are rejected.
X = Depending on the scene (1...8)		
<p>□ Ax – Operating hours counter (x = number of the output A1 ... A4 in switching operation / Only visible in switching operation and only accessible if the parameter "Operating hours counter ?" under "Ax – Enabled functions" is set to "enabled!")</p>		
Type of counter	up-counter down-counter	The operating hours counter can be configured as up-counter or down-counter. This setting has an influence on the visibility of the other parameters and objects of the operating hours counter.
Limit value preset ?	no yes, as specified in parameter yes, as received via object	If the up-counter is used, a limit value can be preset as an option. This parameter defines whether the limit value can be preset in a separate parameter or individually adapted from the bus by an independent communication object. A setting of "No" deactivates the limit value. i This parameter is only visible in the configuration "Type of counter = up-counter".
Limit value (0...65535 h)	0... 65535	This parameter is used for setting the limit value of the up-counter. On reaching this limit value, a "1" telegram is transmitted via the "Operating hours counter elapsed" object. The counter itself continues to run until the max. count (65535) is reached and then stops. i This parameter is only visible if the parameter "Limit value preset ?" is set to "yes, as specified in parameter".
Start value preset ?	No yes, as specified in parameter	If the down-counter is used, a start value can be preset as an option. This parameter defines whether the start value can be preset in a separate parameter

	yes, as received via object	or individually adapted from the bus by an independent communication object. A setting of "No" deactivates the start value.
		i This parameter is only visible in the configuration "Type of counter = down-counter".
Start value (0...65535 h)	0... 65535	This parameter is used for setting the start value of the down-counter. After the initialisation, the counter begins to decrement the hours from the preset value to "0". After reaching the final value, a "1" telegram is transmitted via the "Operating hours counter elapsed" object.
		i This parameter is only visible if the parameter "Start value preset ?" is set to "yes, as specified in parameter".
Automatic transmitting of the counter value ?		The current count of the operating hours counter can be actively transmitted to the bus via the communication object "Value operating hours counter".
	Cyclical	The count is transmitted to the bus cyclically and after a change. The cycle time is programmed under the "Times" entry generally for all outputs.
	after change by interval value	The count is transmitted to the bus only after a change.
Count value interval (1...65535 h)	1... 65535	This parameter is used for setting the counting value interval for automatic transmitting. The current count will be transmitted to the bus after the time interval programmed in this parameter.
		i This parameter is only visible if the parameter "Automatic transmitting of counting value ?" is set to "after change by interval value".
□Ax – Supplementary functions (x = number of the output A1 ... A4 in switching operation / Only visible in switching operation!)		
Selection of supplementary function	no supplementary function	This parameter can be used to define and to enable the supplementary function. The disabling function can only be parameterized as an alternative to the forced position function.
	disabling function	
	Forced position	
Polarity of the disabling object	0 = disabled; 1 = enabled;	This parameter defines the polarity of the disabling object.

1 = enabled;
0 = disabled

- i** The disabling function is always deactivated (object value "0") after bus or mains voltage return or after ETS programming of the application or the parameters. In the inverted setting ("1 = enabled; 0 = disabled"), after initialisation a telegram update "0" has to take place before the disabling function is activated.
- i** This parameter is visible only if the disabling function is enabled.

Behaviour at the beginning of the disabling function

The behaviour of the output at the beginning of the disabling function can be parameterized.

no change of switching state

At the beginning of the disabling function, the relay of the output shows no reaction and remains in the current switching state. Thereafter, the output is locked.

switch off

The output switches off at the beginning of the disabling function and goes into lock.

switch on

The output switches on at the beginning of the disabling function and goes into lock.

flashing

The output flashes on and off during the disabling function and is interlocked during this time. The flashing time is parameterized generally for all outputs under "General". During the flashing the logical switching state is "ON -1".

- i** An output disabled via the bus can still be operated by hand!
- i** This parameter is visible only if the disabling function is enabled.

Behaviour at the end of the disabling function

The behaviour of the output at the end of the disabling function can be parameterized.

no change of switching state

At the end of disabling, the internal switching state is not changed. Thereafter, the output is again enabled.

switch off

At the end of disabling, the switching state is set to off. The output is re-enabled.

Switch on

At the end of disabling, the switching state is set to on. The output is re-enabled.

setting tracked state

The last switching state active before the disabling function or the switching state tracked internally during the disabling function is set at the end of dis-

flashing	<p>abling. Any active time or staircase functions are also taken into account.</p>
Behaviour at the end of the forced position function	<p>At the end of the disabling function the output flashes on and off, and is re-enabled. The flashing continues until a new switching state is specified. The flashing time is parameterized generally for all outputs under "General". During the flashing the logical switching state is "ON 1".</p> <ul style="list-style-type: none"> <li data-bbox="976 576 1511 695"> <p>i The states set at the end of the disabling function do not start any time functions (exception: "setting tracked state").</p> <li data-bbox="976 707 1511 851"> <p>i If a logic operation is parameterized, the state will be evaluated as if the state had been updated via the "Switching" object (no evaluation of time functions).</p> <li data-bbox="976 863 1511 925"> <p>i This parameter is visible only if the disabling function is enabled.</p>
Tracking the switching state	<p>The behaviour of the output at the beginning of a forced position function is directly determined by the forced position telegram. The behaviour of the output at the end of the forced position function can be parameterized.</p> <p>At the end of the forced position state, the switching state last existing before the forced position function or the one tracked internally while the forced position function was active will be set. Any active time or staircase functions are also taken into account.</p>
no change of switching state	<p>At the end of the forced position function, the internal switching state will not be changed. Thereafter, the output is again enabled.</p>
switch off	<p>At the end of the forced position function, the switching state is set to off. The output is re-enabled.</p>
switch on	<p>At the end of the forced position function, the switching state is set to on. The output is re-enabled.</p> <ul style="list-style-type: none"> <li data-bbox="976 1770 1511 1889"> <p>i The states set at the end of the forced position function do not start any time functions (exception: "tracking the switching state").</p> <li data-bbox="976 1901 1511 2043"> <p>i If a logic operation is parameterized, the state will be evaluated as if the state had been updated via the "Switching" object (no evaluation of time functions).</p>

Behaviour after bus voltage return

The communication object of the forced position function can be initialised after bus voltage return. The switching state of the output can be influenced when the forced position function is activated.

no forced position

No forced position is activated after bus return. Reaction of the output in accordance with the parameter "Behaviour after bus or mains voltage return".

forced position on, switch on

The forced position is activated. The output is switched on under forced control.

forced position on, switch off

The forced position is activated. The output is evaluated under forced control.

state of forced position before bus/mains failure

The state of the forced position is preset in the way that it was stored permanently at the point in time of the bus or mains failure. After programming of the application or of the parameters with the ETS, the value is set internally to "not active".

i After programming of the application or of the parameters with the ETS, the forced position is always cancelled.

i This parameter is only visible when the forced position function is enabled.

Logic operation function ?

Yes

This parameter can be used to enable the logic operation function (setting "Yes").

No

i The parameter is fixed to "No" when the staircase function or the cyclical monitoring functions are enabled.

Type of logic operation function

OR

This parameter defines the type of logic operation function. The "Logic operation" object is linked with the logical switching state of the output ("Switching" object after evaluation of any parameterized time delays) based on the logic operation function set here.

AND

AND with feedback

i This parameter is only visible when the logic operation function is enabled.

Object value of logic operation obj. after bus voltage return

0 (OFF)

After bus voltage return the object value of the logic operation object is initialised with the value specified using this parameter.

1 (ON)

Object value of logic operation obj. after ETS download	0 (OFF) 1 (ON)	<p>i This parameter is only visible when the logic operation function is enabled.</p>
		<p>After ETS programming of the application or the parameters, the object value of the logic operation object is initialised with the value specified using this parameter.</p>
		<p>i This parameter is only visible when the logic operation function is enabled.</p>
<p>□Ax – General (x = number of the valve output A5 ...A6)</p>		
Valve direction of action (Valve in deenergized state)	closed open	<p>Both valve drives which are closed in the deenergized state and valve drives which are open in the deenergized state can be connected to the valve outputs of the room actuator. In order for the room actuator to control the connected valve 'in the right direction', the valve direction of action of the connected drives must be configured using this parameter.</p>
Forced position via object	disabled enabled	<p>In the forced position function of a valve output, a constant forced valve position (0 % to 100 %) can be saved in the actuator, which is then adopted as the valve nominal position when the forced position function is activated, and executed via a pulse-width modulation. The forced valve position can be set in the ETS differently for summer or winter mode, if mode of operation change-over is enabled.</p> <p>The forced position function is deactivated, and thus the corresponding object is not visible in the ETS.</p> <p>The forced position function is enabled and the 1-bit communication object "Forced position" is visible in the ETS.</p>
Value for forced position ... (0...100%)	0... 40 ...100	<p>As soon as an "ON" telegram is received via the object, the actuator activates the forced position for the corresponding valve output and moves the valve drive to the forced valve position value specified using this parameter. The value configured here can also be used as a nominal valve position value after ETS programming, after bus voltage failure and after bus or mains voltage return.</p>

		<p>i This parameter is present twice when mode of operation change-over (summer / winter) is enabled.</p>
	enabled	The forced position function is enabled and the 1-bit communication object "Forced position" is visible in the ETS.
Value for emergency operation... (0...100%)	0... 50 ...100	<p>As soon a missing command value telegram has been detected as part of the cyclical command value monitoring, the actuator activates the emergency operation for the corresponding valve output and moves the valve drive to the emergency valve position value specified using this parameter.</p> <p>The value configured here can also be used as a nominal valve position value after ETS programming, after bus voltage failure and after bus or mains voltage return.</p> <p>i This parameter is present twice when mode of operation change-over (summer / winter) is enabled.</p>
Behaviour in case of bus voltage failure		This parameter can be used to configure the state of the valve drives in case of bus voltage failure.
	no reaction	In the event of bus voltage failure the valve output shows no reaction and remains in the switching state last set, as long as the mains voltage of the actuator is still switched on.
	valve closes	The actuator closes the connected valve drives completely in the event of bus voltage failure, as long as the mains voltage of the actuator and the mains voltage of the valve output are still switched on.
	valve opens	The actuator open the connected valve drives completely in the event of bus voltage failure, as long as the mains voltage of the actuator and the mains voltage of the valve output are still switched on.
	valve to value for forced position	The actuator sets the connected valve drives to the value for the forced position (0...100 %) configured in the ETS for each output. With the setting 0 % the output concerned is completely closed, with the setting 100 % completely open.
	valve to value for emergency operation	The actuator sets the connected valve drives to the value for the emergency operation (0...100 %) configured in the ETS for each output. With the setting 0 % the output concerned is completely

		closed, with the setting 100 % completely open.
		i The energization of the valve outputs is always performed taking into account the valve direction of action preset for each output.
Behaviour after bus or mains voltage return		This parameter can be used to configure the state of the valve drives in case of bus or mains voltage return.
	no reaction	In the event of bus voltage failure the valve output shows no reaction and remains in the switching state last set, as long as the mains voltage of the actuator is still switched on.
	valve closes	The actuator closes the connected valve drives completely after bus or mains voltage return.
	valve opens	The actuator opens the connected valve drives completely after bus or mains voltage return.
	valve to value for forced position	The actuator sets the connected valve drives to the value for the forced position (0...100 %) configured in the ETS for each output. With the setting 0 % the output concerned is completely closed, with the setting 100 % completely open.
	valve to value for emergency operation	The actuator sets the connected valve drives to the value for the emergency operation (0...100 %) configured in the ETS for each output. With the setting 0 % the output concerned is completely closed, with the setting 100 % completely open.
	state as before bus/mains voltage failure	After bus or mains voltage return, the state last existing and internally stored <u>before</u> bus or mains voltage failure (last command value/valve nominal position and state of the "Forced position" object) will be tracked. i The energization of the valve outputs is always performed taking into account the valve direction of action preset for each output.
Alarm object for overload / short-circuit	disabled	The room actuator monitors the two valve outputs independently of each other for short-circuits and overload, as soon as the outputs are switched on and energized. The short-circuit and overload detection is generally active for the valve outputs. Optionally, a 1-bit alarm object can be enabled using this parameter, which makes it possible to signal a fault mode caused by a short-circuit or overload in
	enabled	

the bus.

Polarity of "Short-circuit / overload alarm" object
 obj. val. in case of overload / short-circuit = 0
obj. val. in case of overload / short-circuit = 1

The telegram polarity of the 1-bit object "Short-circuit / overload alarm" can be set using this parameter.

i This parameter is only visible when the short-circuit/overload reporting function is enabled.

Time delay for message after bus voltage return ?
 Yes
No

An alarm message that was transmitted to the bus after detection of the fault and has not yet been reset is saved in the actuator in the event of a bus voltage failure. After bus voltage return a previously saved message (alarm) is transmitted to the bus again, if the fault was not reset during the bus voltage failure, and is thus still present. Even if no alarm message is active, a message telegram (no alarm) is transmitted to the bus after bus voltage return and after ETS programming. In these cases, transmission of the alarm telegram can be delayed. This parameter can be used to configure the time delay.

i This parameter is only visible when the short-circuit/overload reporting function is enabled.

□Ax – Command value (x = number of the valve output A5 ...A6)

Type of command value

The valve outputs of the room actuator can be controlled via switching with a 1-bit command value telegram or alternatively constantly with a 1-byte command value telegram. Constant command values are converted via pulse-width modulation at the output.

switching (1 bit)

In normal operation, the switching telegram received via the 1-bit object "Command value" is forwarded directly to the corresponding valve output of the actuator, taking into account the valve direction of action (open in deenergized state / closed in deenergized state. Thus when an "ON" telegram is received, the valve is opened completely (output energized for valve direction of action = closed / output not energized for valve direction of action = open). The valve is closed completely when an "OFF" telegram is received (output not energized for valve direction of action = closed / output energized for valve direction of action = open).

constant (1 byte)

		<p>In normal operation, the value telegram received via the 1-byte object "Command value" is converted by the actuator into an equivalent pulse-width modulated switching signal on the valve outputs. The mean value of the output signal resulting from this modulation is a measure for the averaged valve position of the control valve, taking into account the cycle time which is set in the actuator, and thus a reference for the set room temperature.</p>
<p>Transmit status of the valve position ?</p>		<p>The room actuator makes available a command value status message independently for each valve output. The communication object "Command value status" can be used to transmit to the bus the current valve nominal position depending on the configured command value data format (1 bit or 1 byte).</p>
	<p>no status</p>	<p>The communication object is blanked out in the ETS, which means that the status messaging function is completely inactive.</p>
	<p>status object is actively transmitting</p>	<p>The status message is enabled. As soon as the actuator updates the status message, a telegram is also transmitted to the bus. The "Transmit" flag is automatically set in the bus under the status object.</p>
	<p>status object is passively readable</p>	<p>The status message is enabled. The actuator updates only the status object internally, and does not transmit any telegram. The object value can be read out via the bus at any time (ValueRead), as a result of which the actuator then transmits a response telegram (ValueResponse). The "Read" flag is automatically set in the bus under the status object.</p>
<p>Time delay for status after bus voltage return ?</p>	<p>Yes No</p>	<p>It is possible to set a time delay for the actively transmitting status messages after bus voltage return (switching on of the bus voltage), and also after ETS programming. For this purpose a channel-independent delay time can be defined in the actuator. Only after the parameterized time elapses are status telegrams for initialisation transmitted to the bus. This parameter can be used to configure whether the status message is transmitted with a time delay after initialisation. The delay time itself is configured independent of the channel on the parameter page "General".</p>

Cyclical monitoring of the command value

i This parameter is only visible if "Transmit status of the valve position?" = "status object is actively transmitting".

The room actuator makes it possible to monitor the command value for each valve output. This monitoring checks whether command value telegrams have been received by the room actuator within a time interval that can be defined in the ETS. If no telegrams are received during the monitoring time, the actuator activates the emergency operation and set the connected valve drives to an emergency operation valve position parameterized in the ETS.

disabled

The cyclical command value monitoring is enabled and the communication object "Command value monitoring alarm" becomes visible in the ETS. In fault-free operation the command value object of the corresponding valve output must have telegrams transmitted to it cyclically within the monitoring time.

enabled

The cyclical monitoring is completely disabled. No telegram monitoring of the command value object is performed.

Polarity of "Command value monitoring alarm" object

object value when command values absent = 0

The telegram polarity of the 1-bit object "Command value monitoring alarm" can be set using this parameter.

object value when command values absent = 1

i This parameter is only visible when cyclical command value monitoring is enabled

5 Appendix

5.1 Index

A		P	
Anti-sticking protection.....	58	Parameter group "Automatic heating/ ..201 cooling" blind outputs	
Automatic heating/cooling.....	127	Parameter group "Blind safety times"...	169
B		Parameter group "Channel definition" ..	165
Behaviour after ETS programming.....	53	Parameter group "Command value" ..	228
Blind mode of operation.....	83	valve outputs	
C		Parameter group "Enabled functions" ..	181
Calculating the slat position.....	90	blind outputs	
Change-over time.....	89-90	Parameter group "Enabled functions" ..	213
Channel definition.....	40	switching outputs	
Command value evaluation.....	151	Parameter group "Fabric-stretching" ..	209
Commissioning with the ETS.....	13	blind outputs	
Connection.....	8	Parameter group "Feedbacks" blind ..	182
Cyclical command value monitoring.....	160	outputs	
Cyclical monitoring for switching out- ..	81	Parameter group "Forced position" ..	208
puts		blind outputs	
D		Parameter group "General blind out- ..	168
Decice components.....	6	puts"	
Delay after bus voltage return.....	38	Parameter group "General switching ..	165
Determining and configuring MOVE ..	86	outputs"	
operation		Parameter group "General valve out- ..	170
Determining and configuring STEP ..	86	puts"	
operation		Parameter group "General" ..	165
Determining and configuring travelling ..	87	Parameter group "General" blind out- ..	176
time		puts	
E		Parameter group "General" switching ..	209
ETS search paths.....	23	outputs	
F		Parameter group "General" valve out- ..	225
Fabric-stretching.....	138	puts	
Feedback of the largest command va- ..	57	Parameter group "Manual control".....	174
lue		Parameter group "Operating hours ..	220
Fitting.....	7	counter" switching outputs	
Function.....	3-4	Parameter group "Safety" blind out- ..	185
M		puts	
Mains failure message.....	39	Parameter group "Scenes" blind out- ..	207
Mains voltage monitoring.....	38	puts	
Manual control.....	41	Parameter group "Scenes" switching ..	219
Measuring the slat moving time.....	13	outputs	
Measuring the travelling time extensi- ..	12	Parameter group "Staircase function" ..	215
on		switching outputs	
Measuring the travelling times.....	12	Parameter group "Sun protection" ..	188
Mode of operation change-over.....	54	blind outputs	
		Parameter group "Supplementary ..	221
		functions" switching outputs	
		Parameter group "Time delays" swit- ..	214
		ching outputs	
		Parameter group "Times" blind out- ..	179
		puts	
		Parameter group "Valve output times" ..	173
		Performing a reference travel.....	13
		Position calculation of slat.....	92
		Position feedback.....	96

Presetting the mode of operation.....	83
Presetting the position.....	94
Presetting the STEP operation.....	87
Priorities.....	163
Pulse-width modulation.....	152

R

Reference travel.....	93
Reset and initialisation behaviour for blind outputs	83

S

Safe-state mode.....	26
Safety function.....	100
Safety functions, global.....	49
Scene function.....	133
Scene function switching outputs.....	71, 73
Slat moving time.....	88
Staircase function.....	64
State as supplied.....	164
Status message All valves closed.....	56
Status message for valve position.....	158
Sun protection application examples...	123
Sun protection function.....	103
Switching mode of operation.....	59
Switching status feedback.....	62

T

Time delays for switching outputs.....	63
Travel movement feedback.....	98
Travelling time extension.....	89

U

Unloading the application program.....	26
--	----

V

Valve direction of action.....	141
Version of application program.....	26

Gira
Giersiepen GmbH & Co. KG
Elektro-Installations-
Systeme

Industriegebiet Mermbach
Dahlienstraße
42477 Radevormwald

Postfach 12 20
42461 Radevormwald

Deutschland

Tel +49(0)21 95 - 602-0
Fax +49(0)21 95 - 602-399

www.gira.de
info@gira.de